

QST

DEVOTED ENTIRELY TO

AMATEUR RADIO

Published by the American Radio Relay League

IN THIS ISSUE:
THE THEORY AND PRACTICE OF
- SHIELDING -



MARCH
1926

25¢

Cunningham

RADIO TUBES



Confidence in a Name

KNOWLEDGE derived from his own experience soon convinces the radio recruit that all radio tubes are *not* alike--no matter how similar their appearance. And from his own experience he reaches the con-

clusion of millions--that the best guarantee of hidden value and unseen protection in a radio tube is in the name Cunningham, with a reputation zealously guarded since 1915.

E. J. Cunningham Inc.

Chicago

San Francisco

New York

For Transmitting as well as Receiving

Ray-O-Vac Radio Batteries Give a Steady, Uniform Voltage and Have Exceedingly Low Internal Resistance.

* * *

Transmitting makes rigid demands on the current supply. Any diminution or unevenness in current affects the beat of your wave and lowers your chances of having your call picked up.

That's why so many amateur transmitters use Ray-O-Vac batteries. These batteries deliver a steady, uniform voltage that makes better transmission possible. Because they have *low internal resistance*, they deliver signals free from distortion.

And Ray-O-Vacs have staying power in this work, too. It is not unusual for a Ray-O-Vac 22½ volt B battery to wear down to 17 volts without distort-

ing signals. Other sizes and types are equally long-lived.

No less a radio authority than Dr. Lee de Forest—the father of radio broadcasting—uses Ray-O-Vacs in all his experimental work.

At the 2nd Radio World's Fair at Chicago all the amateur radiograms that were sent out were by transmitters using 540 volts of Ray-O-Vac No. 9303 B batteries. After six days of practically continuous use from 2:00 to 11:00 P. M. each day, none of these 12 batteries showed a drop in voltage of over 1½ volts.

Keep your apparatus equipped with Ray-O-Vacs for all plate and grid batteries. They give you a new degree of battery longevity.

If the stores where you ordinarily buy do not have Ray-O-Vac radio batteries, write us for the name of the nearest dealer or jobber who can supply you.

FRENCH BATTERY COMPANY, Madison, Wisconsin

Ray-O-Vac "B" batteries in all standard sizes, both flat and upright.



Ray-O-Vac "A" batteries recuperate during rest periods, lasting longer and giving excellent reception.

Ray-O-Vac 4½ volt "C" batteries with 3 variable terminals give voltage adjustment of 1½, 3 and 4½ volts.

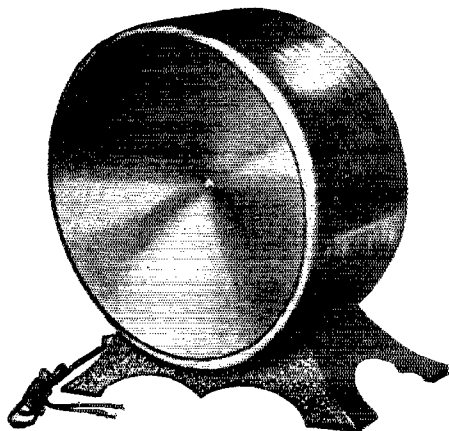

The Acme "double free-edge cone" loud speaker. Puts back into the so-called "shadow voice" the living, recognizable, individualistic tones of each speaker. Round model (shown) \$25. Cabinet model, \$35.

Here's some straight "dope"that you can bank on!

WE DON'T believe we need be finicky when we tell you old timers of Q. S. T. about loud speakers.

You know how the market is flooded with all kinds, all shapes and all "super-perfect" claims.

All we need tell you fellows about the new Acme "double free-edge cone" Loud Speaker is simply this. It does give you exact reproduction of the human voice and all musical instruments. That's all — and that's enough.

Of course, if it's placed on a poor set, it cannot help but show up the set's defects.

But you fellows have no need to worry about that.

On any set you swear by, you can bank on Acme giving you perfect results.

The whole story of distortion, and how this and other Acme products help overcome it, is told in "Amplification without Distortion." The 10th edition is now ready. When you send for it, ask also for our Bulletin (T) on Transmitting Apparatus.

Claude Hain

President Acme Apparatus Co.

Send for
your copy!

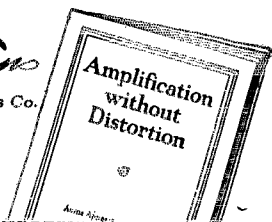

ACME APPARATUS COMPANY
Dept. E14, Cambridge, Mass.

Enclosed find ten cents stamps or coin for my copy of the new tenth edition of "Amplification without Distortion." Please also send Bulletin T Acme Transmitting Apparatus.

Name.....
Street.....
City.....State.....
Station Call.....

ACME

~for amplification

THE TRAFFIC DEPARTMENT, A. R. R. L.

Manager
 A.D.M. D. of C.
 A.D.M. Maryland
 A.D.M. So. N. J.
 A.D.M. West. N. Y.
 A.D.M. East. Pa.
 A.D.M. West. Pa.
 A.D.M. Delaware

3DW
 5AB
 3HG
 3EH
 8PJ
 3FM
 8ZD
 3AIS

Manager
 A.D.M. Michigan
 A.D.M. Ohio
 A.D.M. Illinois
 A.D.M. Wisconsin
 A.D.M. Indiana
 A.D.M. Kentucky

8ZZ
 8ZZ
 8AA
 9AAW
 8VD
 8CQ
 8EI

Manager
 A.D.M. Minnesota
 A.D.M. So. Dak.
 A.D.M. No. Dak.

8ZT-9XAX
 8EGU
 9CDS
 9EPN

Manager
 A.D.M. Mississippi
 A.D.M. Arkansas
 A.D.M. Tennessee
 A.D.M. Louisiana

4MM
 5AKP
 5XAB
 4KN
 6UK

Manager
 A.D.M. No. N. J.
 A.D.M. N. Y. C.
 A.D.M. East. N. Y.

2BRB
 2WR
 2CWR
 2PV

Manager
 Asst. Secy. to DM.
 A.D.M. Iowa
 A.D.M. Mo.
 A.D.M. Kansas
 A.D.M. Nebraska

9DXY
 9ARZ
 9RR
 9C8S
 9CJT

Manager
 A.D.M. R. I.
 A.D.M. N. H.
 A.D.M. Vt.
 A.D.M. W. Mass.
 A.D.M. E. Mass.
 A.D.M. Conn.
 A.D.M. Maine

1AWW
 1BVB
 1GL
 1AIG
 1ASU
 1KY
 1RM
 1CU

Manager
 A.D.M. Montana
 A.D.M. Wash.
 A.D.M. Oregon
 A.D.M. Idaho
 A.D.M. Alaska

7EK ex TABB
 7NT
 7PD
 7PB-XAF
 7OR
 7DE

Mgr. Southern Section
 A.D.M. Dist. 1, 2, 3
 A.D.M. Ariz.
 Mgr. Northern Section
 A.D.M. Dist. 4
 A.D.M. Dist. 5
 A.D.M. Dist. 6
 A.D.M. Nevada
 Mgr. Hawaiian Section
 A.D.M. Hawaii

6BUR
 6CTO
 6ANO
 6ZX
 6NX
 6UO
 6TO
 6BCG

Manager
 A.D.M. West Va.
 A.D.M. Virginia
 A.D.M. No. Carolina

5RZ
 8RSD-AKZ
 3CA
 4JR

Manager
 A.D.M. Colo.
 A.D.M. Utah

720
 9CAA
 6ZT

Manager A.D.M. Ala.
 A.D.M. S. C.
 A.D.M. Ala.
 A.D.M. Fla.
 A.D.M. Ga.
 A.D.M. Porto Rico

5APJ
 1RR
 5AX
 4IO
 4OI

Manager
 A.D.M. Oklahoma
 A.D.M. So. Texas
 A.D.M. No. Texas

5ZC
 5APG
 5YK
 5AJT

Manager
 A.D.M. P. E. I.
 A.D.M. N. B.

1DD
 1RZ
 1EI

Manager
 A.D.M. Cen. Ont.
 A.D.M. East. Ont.
 A.D.M. So. Ont.

9HJ
 3VH
 3APP
 3NY

Manager

2CG

Manager

4GT

Manager
 A.D.M. Sask.
 A.D.M. Manitoba

4DE
 4CB-9BX
 1DE

ATLANTIC DIVISION

E. B. Duvall
 A. B. Goodall
 G. L. Deichmann, Jr.
 H. W. Densham
 C. S. Taylor
 J. F. Rau
 F. E. Wiggin
 H. H. Layton

Box 317
 1824 Ingleide Ter.
 Chapel Gate Lane
 140 Washington St.
 598 Masten St.
 1551 So. 58th St.
 714 Johnson St.
 805 Washington St.

Edmonston, Md.
 Washington
 Ten Hills, Baltimore
 Collingswood
 Buffalo
 Philadelphia
 Wilkensburg
 Wilmington

CENTRAL DIVISION

C. E. Darr
 C. E. Darr
 C. E. Nichols
 W. E. Schweitzer
 C. N. Crapo
 D. J. Ankus
 J. C. Anderson

137 Hill Ave., Highland Pk.
 137 Hill Ave., Highland Pk.
 739 Weadock Ave.
 4264 Hazel Ave.
 443 New Union Ave.
 310 N. Illinois St.
 Glensary Farm

Detroit, Mich.
 Detroit
 Lima
 Chicago, Ill.
 Milwaukee
 Indianapolis
 Lexington

DAKOTA DIVISION

D. C. Wallace
 C. L. Barker
 M. J. Jenkins
 George R. Moir

64 N. Penn Ave.
 820 4th St.

Minneapolis, Minn.
 Hennepin
 Bryant
 N. Fargo, N. Dak.

DELTA DIVISION

B. P. Painter
 J. W. Gullett
 Dr. L. M. Hunter
 E. K. Rush
 C. A. Freitag

324 Hamilton Nat. Bank Bldg.
 819-29th Ave.
 2974 Main St.
 4 Second St.
 3520 Forshey St.

Chattanooga, Tenn.
 Meridian
 Little Rock
 Evans
 New Orleans

HUDSON DIVISION

E. M. Glaser
 A. G. Wester, Jr.
 F. H. Mardon
 H. N. Ammenheuser

845 E. 13th St.
 1075 Chancellor St.
 1309 W. Farms Rd.
 178 Quail St.

Brooklyn, N. Y.
 Irvington
 Bronx
 Albany

MIDWEST DIVISION

P. H. Quinby
 C. E. Diehl
 D. E. Watts
 L. E. Laizure
 C. M. Lewis
 H. A. Nielson

Box 134A, Rt. 6
 3006 S. 32d Ave.
 116 Hyland Ave.
 8020 Meriter St.
 312 E. Rutledge St.
 4708 N. 39th St.

Omaha, Nebr.
 Omaha
 Ames
 Kansas City
 Yates Center
 Omaha

NEW ENGLAND DIVISION

T. P. Cushing
 D. B. Fancher
 C. P. Sawyer
 Charles T. Kerr
 C. V. Green
 Miss Gladys Hannah
 H. E. Nichols
 S. B. Coleman

78 College St.
 86 Franklin St.
 11 Stark St.
 6 Airle St.
 7 Summer Rd.
 800 Betham Ave.
 11 James St.

Springfield, Mass.
 Westley
 Manchester
 Poulney
 Worcester
 Cambridge
 Bridgeport
 Bangor, Maine

NORTHWESTERN DIVISION

Everett Kiek
 A. R. Willson
 Otto Johnson
 Ashley C. Dixon, Jr.
 K. S. Norquest
 Leo H. Machin

5802 Hoyt Ave.
 4340 30th West
 1350 East 38th St.
 Weather Bureau
 Box 452

Everett, Wash.
 Ramsey
 Portland, Ore.
 Boise
 Cordova, Alaska

PACIFIC DIVISION

L. E. Smith
 E. H. Burgman
 D. B. Lamb
 F. W. Dunn
 F. J. Guement

304 N. Painter Ave.
 1200 Tamrind Ave.
 229 W. First St.
 582-38th St.
 51 Pleasant St.

Whittier, Calif.
 Hollywood
 Mesa
 Oakland
 San Jose

St. Clair Adams
 C. B. Newcomb
 K. A. Cantin
 W. H. Friedly

1583 Pihoki St.
 1825 Dole St.

Eureka
 Yerrington
 Honolulu, T. H.
 Honolulu, T. H.

ROANOKE DIVISION

W. T. Gravely
 C. S. Hoffman, Jr.
 J. F. Wohford
 R. S. Morris

424 Main St., Box 245
 126 Chantal Court
 118 Cambridge Ave.
 413 S. Broad St.

Danville, Va.
 Wheeling
 Roanoke
 Gastonia

ROCKY MOUNTAIN DIVISION

N. R. Hood
 C. R. Stedman
 Art Johnson

1022 S. Ash St.
 1641 Albin St.
 247 E. 7th South St.

Casper, Wyo.
 Denver
 Salt Lake City

SOUTHEASTERN DIVISION

A. D. From
 A. Dunne
 H. S. Brownell

217 Catona St.
 270 Wofford Campus
 Birmingham Elec. Co.

Montgomery, Ala.
 Spartanburg
 Birmingham, Ala.

J. Morris
 Lulu Rexach

58 Frederica St.
 Box 319

Atlanta
 San Juan

WEST GULF DIVISION

F. M. Corlett
 K. M. Phret
 E. A. Salm
 W. B. Forrest, Jr.

2515 Catherine St.
 2904 N. Robinson St.
 Box 368
 502 Royal St.

Dallas, Texas
 Oklahoma City
 New Braunfels
 Waxahachie

MARITIME DIVISION

W. C. Borrett
 W. Hyndman
 T. B. Lacey

14 Sinclair St.
 c/o N. B. Power Co.

Dartmouth, N. S.
 Charlottetown
 St. John

ONTARIO DIVISION

W. T. Sloan
 A. R. Williams
 F. A. C. Harrison
 J. E. Hayne

187 Glasa Ave.
 56 Madison Ave.
 181 Hopewell Ave.
 303 N. Brock St.

Toronto Ont.
 Toronto
 Ottawa
 Sarnia

QUEBEC DIVISION

J. V. Arkyle

493 Decarie Blvd.

Montreal, Que.

VANCOUVER DIVISION

A. H. Amussen

223 2nd Ave. N. E.

Calgary, Alberta

WINNIPEG DIVISION

F. E. Rutland
 E. L. Maynard
 F. E. Rutland, Jr.

452 St. John Ave.
 452 St. John Ave.

Winnipeg
 Morse
 Winnipeg

Grebe
"Colortone"



Flexible Unit Control



The high-wave reception range of the Grebe dial (B)—from 550 down to 240 meters—equals the practical tuning range of the usual receiver. The low-wave range of the Grebe dial (A) provides additional reception down to 150 meters.

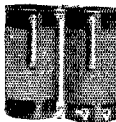

Grebe
Binocular Coils
Sec. U. S. Pat. 02.
and
Low-wave
Extension
Circuits

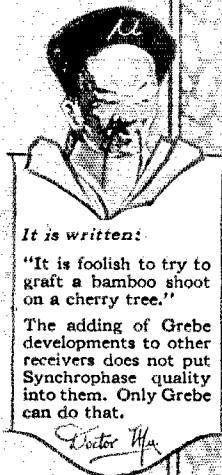

It is written:

"It is foolish to try to graft a bamboo shoot on a cherry tree."

The adding of Grebe developments to other receivers does not put Synchrophase quality into them. Only Grebe can do that.

Doctor Ma



All Grebe apparatus is covered by patents granted and pending.

Always Well in Advance

THE Synchrophase, as usual, is fully a year in advance of other receivers. This is due to those Grebe developments which have contributed so much to the improvement of radio reception. As past experience will show, these advances may be adopted, perhaps next year, on sets of other manufacturers.

So, in buying a Synchrophase *now*, you are assured of a receiver well in advance of others, and a quality of reception which they will take some time in equalling, if ever.

A demonstration by your dealer will convince you.

A. H. Grebe & Co., Inc., 109 West 57th St., N. Y.

Factory: Richmond Hill, N. Y.

Western Branch: 443 So. San Pedro St., Los Angeles, Cal.

This company owns and operates stations WAHG and WHOJ; also low-wave re-broadcasting stations, mobile WGMU and marine WRMU.

THE GREBE SYNCHROPHASE

TRADE MARK REG. U. S. PAT. OFF.

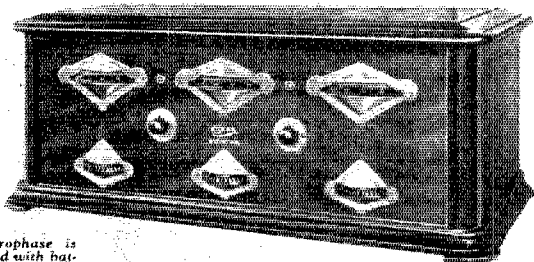

The Synchrophase is also supplied with battery base.



QST



The Official Organ of the A.R.R.L.

VOLUME X

MARCH 1926

NUMBER 3

Editorials	7
Standard Frequency Schedules	8
Official Wavelength Stations	8
Central Division Convention	8
The Shielding Problem	9
A Low-Capacity Variable Condenser	20
Volume IX Index	20
Multiplex Short-Wave Reception	21
Novel Straight-Frequency-Line Condenser	23
The Old Reliable	24
A Power Amplifier for the Low-Powered Transmitter	29
Some Changes at Headquarters	30
6XBR, 108 Meters	31
Amateur Radio to the North Pole Again	38
Neutralizing the Crystal Amplifier	36
"Pee QSL Card"	37
Tube Reactivation	38
Second District Convention	38
Finding the Inductance of the Filter Choke	39
The 1926 Cooper Cup	41
Tuner Design	42
Plug-In Choke Coils	42
Ford Coil Filters	43
Radio Legislation Pending	44
Experimenters' Section Report	45
Finding the Plate Resistance	46
For Short-Wave Tuners	46
The Receiving Experimenter	47
Who's Who in Amateur Wireless	48
Amateur Radio Stations 6HM	49
I. A. R. U. News	52
Communications	56
HAM ADS	59
QRA Section	92
QST's Directory of Advertisers	95

Official organ of the A.R.R.L. and the International Amateur Radio Union

QST is published monthly by The American Radio Relay League, Inc., at Hartford, Conn., U. S. A.

Kenneth B. Warner (Secretary, A.R.R.L.),
Editor-in-Chief and Business Manager

F. Cheyney Beekley,
Managing Editor and Advertising Manager

Robert S. Kruse,
Technical Editor

John M. Clayton,
Assistant Technical Editor

David H. Houghton,
Circulation Manager

Subscription rate in United States and Possessions, Canada, and all countries in the American Postal Union, \$2.00 per year, postpaid. Single copies, 25 cents. Foreign countries not in American Postal Union, \$2.50 per year, postpaid. Remittances should be by international postal or express money order or bank draft negotiable in the U. S. and for an equivalent amount in U. S. funds.

Entered as second-class matter May 29, 1919, at the post office at Hartford, Connecticut, under the act of March 3, 1879. Acceptance for mailing at special rate of postage provided for in section 1103, Act of October 3, 1917, authorized September 8, 1922. Additional entry as second-class matter, acceptable at special rate of postage provided for above, at Springfield, Mass., authorized September 17, 1924.

Copyright 1925 by the American Radio Relay League, Inc. Title registered at United States Patent Office.
Member of the Radio Magazine Publishers' Association.

THE AMERICAN RADIO RELAY LEAGUE

The American Radio Relay League, Inc., is a non-commercial association of radio amateurs, bonded for the promotion of interest in amateur radio communication and experimentation, for the relaying of messages by radio, for the advancement of the radio art and of the public welfare, for the representation of the radio amateur in legislative matters, and for the maintenance of fraternalism and a high standard of conduct.

It is an incorporated association without capital stock, chartered under the laws of Connecticut. Its affairs are governed by a Board of Directors, elected every two years by the general membership. The officers are elected or appointed by the Directors. The League is non-commercial and no one commercially engaged in the manufacture, sale or rental of radio apparatus is eligible to membership on its Board.

"Of, by and for the amateur", it numbers within its ranks practically every worth-while amateur in the world and has a history of glorious achievement as the standard-bearer in amateur affairs.

Inquiries regarding membership are solicited. A bona fide interest in amateur radio is the only essential qualification; ownership of a transmitting station and knowledge of the code are not prerequisites. Correspondence should be addressed to the Secretary.

OFFICERS

President
HIRAM PERCY MAXIM
Hartford, Conn.

Vice-President
CHAS. H. STEWART
St. David's, Pa.

Traffic Manager
F. H. SCHNELL
Hartford, Conn.
Canadian Gen. Manager
A. H. K. RUSSELL
6 Mail Bldg.,
Toronto, Ont.

Treasurer
A. A. HEBERT
Hartford, Conn.

Secretary
K. B. WARNER
Hartford, Conn.

DIRECTORS

President
HIRAM PERCY MAXIM
Drawer 4,
Hartford, Conn.
Vice-President
CHAS. H. STEWART
St. David's Pa.
Canada
A. H. K. RUSSELL
6 Mail Bldg.,
Toronto, Ont.
Atlantic Division
DR. EUGENE C. WOODRUFF
234 W. Fairmount Ave.,
State College, Pa.
Central Division
CLYDE E. DARR
187 Hill Ave., Highland Park,
Detroit, Mich.

Dakota Division
C. M. JANSKY, JR.
Dept. of Elec. Eng., U. of M.,
Minneapolis, Minn.
Delta Division
BENJ. F. PAINTER
424 Hamilton Nat'l Bank Bldg.,
Chattanooga, Tenn.
Hudson Division
DR. LAWRENCE J. DUNN
480 East 19th St.,
Brooklyn, N. Y.
Midwest Division
PORTER H. QUINBY
Box 134A, Route 6,
Omaha, Neb.
New England Division
DR. ELLIOTT A. WHITE
Dartmouth College
Hanover, N. H.
Northwestern Division
K. W. WEINGARTEN
3219 No. 24th St.,
Tacoma, Wash.

Pacific Division
ALLEN H. BABCOCK
66 Market St.,
San Francisco
Roanoke Division
W. TREDWAY GRAVELY
503 Main St.,
Danville, Va.
Rocky Mountain Division
PAUL M. SEGAL
c/o District Attorney,
West Side Court Bldg.,
Denver, Colo.
Southeastern Division
HARRY F. DOBBS
c/o Dobbs & Wey Co.,
Atlanta, Ga.
West Gulf Division
FRANK M. CORLETT
2515 Catherine St.,
Dallas, Tex.

Address General Correspondence to Executive Headquarters, Hartford, Conn

EDITORIALS

Roll Over

'SAFUNNY thing, but somehow or other it seems that about this time every year a whole flock of our stations get to operating on unauthorized waves. Perhaps it is because it is the height of the season, with more stations operating than at any other time. At any rate it represents a distressing situation, and one about which we must do something.

Just lately we amateurs have protested the operation of Naval short-wave stations handling Government traffic in our bands, and an agreement has been reached between Navy officials and League officers under which the Navy stations have discontinued this practice, as recently announced in our columns. We are also complaining about transmissions within our bands by non-amateur experimental stations and have assurances from the Government that these will cease too. It now becomes definitely necessary for us to set our own house in order. We haven't any right to demand that everything else get out of our bands when we are slopping over into the other fellows' bands ourselves. He who seeks justice must first himself do justice.

This we are not now doing. A huge percentage of our stations is working off-wave. The entire short-wave spectrum has been divided into neat little slices and parcelled out to various classes of radio services. Some of these bands belong to us but most of them do not, and we must stay inside our own fences. A glance at the table on page 35 of our January issue will show that if we stray from our allotted territory we immediately trespass on another service. This arrangement has been in effect for about a year and a half but it is only recently that the territory around our bands has been actively occupied by other radio folks. Now, however, they are there, and they are objecting to our operation in their bands the same as we complained when our preserves were invaded.

The Government, for example, has been assigned bands from 4000 to 4525 kc (75 to 66.25 meters), 8000 to 9050 kc. (37.43 to 31.56 meters) and 11,400 to 14,000 kc (26.3 to 21.42 meters), and the Navy in particular has a large number of stations operating in the 8000-9050 kc. band. Since these bands join ours, it is very important that we keep within our limits—just as important as it is that the Government stations stay where they belong. Again, some of these bands

have been assigned for relay broadcasting, where it is very important that no interference occur. But KDKA's new relay system, linking four broadcasting stations, has been interfered with by amateur transmission on 61 meters, a wave far removed from any amateur assignment!

We are also trespassing seriously on the rights of amateurs in other countries. Amateurs all over the world want to be able to work somewhere in the vicinity of 40 meters and again somewhere in the vicinity of 80 meters. By hard work they have secured such assignments from their governments, and in most cases these assignments are based on our own U.S. assignments and arranged so as not to interfere. When we operate above and below our assigned bands we invade their territories and it becomes impossible to connect with them. As an example of this, illegal operation by American amateur stations between 30 and 37.5 meters has reached such proportions in recent weeks as to make it almost impossible to establish international QSO with foreign amateurs who are assigned those waves.

Some of this illegal operation is accidental and unintentional. Some of it is deliberate, resulting from the temptation to move into a band where there is but little QRM. Both must cease. Headquarters is receiving so many complaints about the situation that we know that if it is not remedied *very pronto*, the Government will be after us with the Big Stick and we will lose some of our privileges.

Now for the remedy. It is largely an individual matter. If every reader of these lines will consider that he is being addressed in person, and act accordingly, the deed will be done. If you think you're operating on your proper wave, make sure. If you're not where you belong, move over—get on your own side of the fence. Get a wavemeter—it's criminal to try to operate without one nowadays. Make use of the transmissions of A.R.R.L. Official Wave Length Stations, of which a list appears in each *QST*. Watch for the scheduled standard-frequency transmissions, announced in our pages, and calibrate your wavemeter or receiver therefrom, from which you can adjust your transmitter. Ask another amateur station with a good wavemeter to tell you your QRH. NKF in particular will gladly do this for all amateurs who can work him. NKF has also established a transmitter on a wavelength slightly below 37.5 meters, testing at noon and midnight E.S.T., and if your wavelength is lower than that you receive from this

transmitter, it is a safe bet that you are within the Navy's prize band between 8000 and 9050 kc.

This screed is by way of being a warning. If individual League members act in

this matter, all will be well and we will preserve our fine reputation for always playing the game. There is trouble ahead for those who don't.

—Kenneth Bryant Warner.

Standard Frequency Schedules

THE frequencies in kilocycles indicated by the attached schedule (corresponding approximate wavelengths given in parentheses) will be transmitted every Friday night from u1XM, the experimental station of the Massachusetts Institute of Technology Radio Society, acting in co-operation with the M. I. T. Communications Laboratory. (See p. 44 of QST for Jan., 1926.) It is hoped to continue this service till May 23th, but further announcements will appear in April QST. Each frequency will be approximately as given, but while the "long dashes" referred to below are being sent the exact frequency will be measured by a very carefully checked Standard Frequency Meter, and then announced. All transmissions will be unmodulated continuous wave telegraphy. It was thought that the maximum benefit would be derived from this service by amateurs by sending the same schedule every Friday night, but so many requests have been received for more points in several bands that the policy indicated above has been adopted. Slight shifts in frequency during the "QST" part is due to an effort to arrive exactly at the predicted frequency for the convenience of users. It is not expected that nearby stations will hear the 15,000 KC signals, but reports are requested from any that do hear them.

The 7-minute period of each transmission will be divided as follows:

2 minutes—QST QST QST u 1XM 1XM 1XM, etc.

3 minutes—Series of long dashes broken by "1XM".

1 minute—Announcement of exact frequency just sent.

1 minute—Announcement of approximate next frequency to be sent.

Four minutes will then intervene while the transmitter is being adjusted to the next frequency. The accuracy that may be expected is 0.2 of 1% or better.

1 XM

SCHEDULE OF FREQUENCIES IN KILOCYCLES (Approximate wavelengths in meters in parentheses)

Time P. M.	March 5,		March 12	March 26
	March 19	April 2		
9:00—9:07	16000 (18.74)		9000 (33.3)	16000 (18.74)
9:11—9:18	15000 (19.99)		8750 (34.3)	15500 (19.34)
9:22—9:29	14000 (21.41)		8500 (35.3)	15000 (19.99)
9:33—9:40	8500 (35.3)		8250 (36.3)	14500 (20.68)
9:44—9:51	8000 (37.5)		8000 (37.5)	14000 (21.41)
9:55—10:02	7500 (40.0)		7750 (38.7)	4000 (75.0)
10:06—10:13	7000 (42.8)		7500 (40.0)	
10:17—10:24	6500 (45.7)		7250 (41.3)	3900 (76.9)
10:28—10:35	6000 (48.8)		7000 (42.8)	3750 (80.0)
10:39—10:46	5750 (50.9)		6750 (44.4)	3600 (83.3)
10:50—10:56	5500 (53.7)		6500 (46.1)	3500 (85.7)
11:05	A. R. R. L. OFFICIAL BROADCAST AT 7500 KC (40.0)			

Reports will be appreciated from all stations using this service whether the distance is large or small. Please mention comparative audibility on the different bands. Drop your card to Standard Frequency Committee of u1XM, M.I.T. Radio Society, Cambridge, Mass., U. S. A.

—K. V. R. L.

Official Wavelength Stations

A CHECK-UP on all O.W.L.S. is being made, and where we find that the O.W.L. Station is not signing off with the wave at each transmission his appointment will be cancelled. O.W.L.S. all agreed to do this before being appointed.

Many O.W.L.S. are following the new plan of signing off with kilocycles instead of meters; so don't be surprised if you hear "u9ZT 7500 k" instead of the usual "u9ZT 40 k", or something similar from other O.W.L. Stations.

Following is the latest list of active O.W.L.S..

NKF**	9DXN	6TS-6XAG	c4FV
1XAM	9EGU	8GZ-8ZG	a2CM
6BQB	6ZH	3BGK	z2OD
7BU	5AKN-5XBH	6XAD-6ZW	6CAE
6MN	2MU	g2NM	6AGN
9AAL	4BY**	6TI	9AXQ
z2AC	9ZA	c8NI	9DOA
2WC**	7GE-7GX	c9AL	5EW
9ZT-9XAX	11V	6CDN	1CPQ
9FF	9EIB	8APZ	6CDY-6CPX
3GU-8XC	7GQ	2SZ	9BGH
9XI	2DS	7GK-7MX	z2SZ
1CK	1BZQ	6LJ	1XM*
1AWW	6BGM-6CVO	5OX	6BX
3ZW-3BE	2XI	9BMR	6BB
8AA	9IG	6BCP	c8KA
8EQ	7ACI	1AAC-1ZO	z5LF**
3APV	1ZL-1AVW	5BZT	1KP
4XE**	2CLA	63CO	
5ZAV	6ZE	9AXQ	

* Special O. W. L. S. Standard Wave Station.

** Crystal-Controlled O. W. L. Stations.

Central Division Convention (Michigan State)

AT Kalamazoo, Michigan, on March 26-27, PARK AMERICAN HOTEL. This is the second notice fellows and from what "Jimmie" Wilson again writes, this 4th Annual Convention will surpass all others; and it is only FIVE DOLLARS for everything too.

COME! COME! And you will not regret it.

—A. A. H.

The Shielding Problem

By D. R. Clemons*

It is very hard to dodge trouble when one does not know where it comes from. Perhaps that is why designers frequently have the discouraging experience that shielding does many things besides those that it is meant to do—and sometimes even aggravates the troubles it is aimed at.

Mr. Clemons shows by experiment how shielding operates, and just how its performance is changed by spacing, coil shapes, wavelength, shield material and by the connections of the set. When that is done most of the shielding mysteries become plain.

THE general tendency at this time is to enclose radio receiving apparatus within a cabinet. In doing this the electrical reactions of one part upon another are increased. To prevent these reactions as far as possible, the principle of screening is frequently resorted to by encasing all or parts of the apparatus in metal containers. Although very elaborate methods of shielding have been provided it is not possible to shield a coil completely. Of course sufficiently good shielding may be obtained to prevent certain harmful effects but sensitive instruments will still display the effects of leakage through very good shields of nearly perfect construction.

How Shields Work

Let a plate of glass be placed before a solenoid as shown in Fig. 1. A current started in the coil causes a growth of magnetic force which extends out through the plate B. As the plate is an insulator there

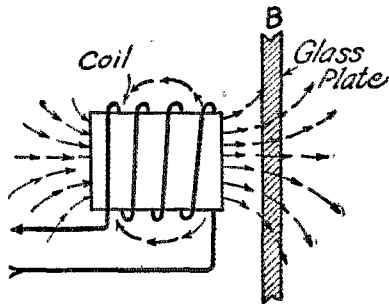

FIG. 1

INSULATING PLATE IN THE FIELD OF A COIL SHOWING UNDISTURBED MAGNETIC FIELD

will be no noticeable current generated in it but there will certainly be an electric motion in the glass, a transient displacement during the short interval of field growth. The field will not be particularly deformed by this and will take a symmetrical position as if the glass were not there.

Now, if a copper ring is placed before the solenoid as B in Fig. 2, a growth of the field from A induces a current in the ring

B, and we find that these two fields will oppose as shown by their rotation. Obviously at X and Y of Fig. 2 we have the component of those two magnetic forces acting in that region. Due to the resistance of the ring B (however low it may be), the magnetic force from A will very quickly extend through B and become re-located as in Fig. 1, at which instant the current in B is zero, but during their

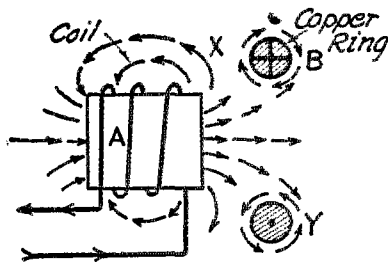

FIG. 2

COPPER RING IN THE FIELD OF A COIL SHOWING THAT THE RING ACTS AS A SECONDARY WINDING AND PRODUCES A FIELD OF ITS OWN TENDING TO DISTORT THE FIELD OF THE COIL

growth, both fields repel violently and assume a somewhat distorted position as shown in Fig. 2; therefore the self induction is decreased. This effect may be clearly imagined by a study of coil shapes, Fig. 18.

Now, let a plate of copper or brass be placed as shown in cross-section in Fig. 3. While a current is being established in the solenoid A, a flux is generated as shown by the arrows. Currents are induced in the plate similar to those of Fig. 2 at B. These are shown as a shaded area in B; therefore, the flux which is established by these currents in the plate is opposed to the flux of the coil A. Currents in the plate B tend to prevent any action between coil A and coil C which is on the opposite side of the plate. By investigation of the subject we find that, due to the resistance of the sheet B, it is impossible to prevent some action of the coil A upon the coil C.

The Perfect Shield

J. Clerk Maxwell shows that a perfect shield or screen between A and C must

* Instructor in Radio, Dodges Institute, Valparaiso, Indiana, Member I.R.E., Consulting Radio Engineer.

have absolutely zero resistance and an infinite area. Were such a shield possible, any current in the coil A develops in the perfect shield a current such that its magnetic force at any instant is opposite and exactly equal to the force approaching it from the coil being shielded. With this condition action could not take place upon

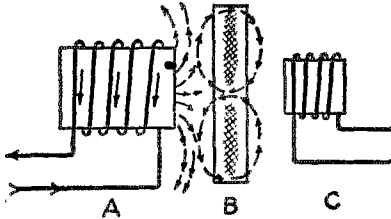

FIG. 3

COPPER PLATE WITH SECONDARY FIELD DISTORTING THE PRIMARY FIELD OF COIL A AND THEREBY SHIELDING SECONDARY COIL C

a coil on the other side of the shield at any time. If this shield of zero resistance entirely surrounds the shielded coil as a spherical shield or other complete enclosure, it becomes equivalent to an infinite area and its shielding is perfect in all directions from the shielded coil.² Of course a study of theoretical cases involving infinity and zero is quite repellent to many people, but it is helpful to consider them in attaining better results.

The Effect of Frequency

Where we are limited (as we are) to materials having some resistance, it becomes clearly impossible to shield a magnetic field completely, particularly at very low frequencies. For low frequency a thick metal shield is better since its resistance to slow changes of current is very low as compared with thin sheets; moreover, thin shields give practically no screening whatever at low frequencies, and none at all for a field of constant position. To shield stationary magnetic fields, iron of considerable thickness must be carefully prepared and an enormous quantity of iron must be used, or at least several shells of progressive radii must be provided.

Much experimental work was done in

1. Practically, one always has to leave openings through which wires can enter. This alone is enough to prevent complete shielding. The very small size of the opening that will allow energy to enter is amazing. In a particular case a receiving set with three stages of R.F. amplification was enclosed (headset, batteries and all) within a copper case inside an iron case. It was perfectly quiet although tuned to WQK which was about 50 miles distant. A one inch hole was then made through both cases and WQK was at once heard with an audibility of perhaps 10. When the lid of the compound case was raised 1/16" all shielding effect disappeared entirely. One must admit, however, that this was at a very long wave, likewise WQK's field is unusually strong, even at 50 miles.—Tech. Ed.

1879 by Prof. Hughes. With his induction balance he found that although silver came first, aluminum was found to be better than copper, which can be explained by the fact aluminum has a higher conductivity per unit of mass than copper. About 1883, Mr. Willoughby Smith made an important series of investigations. He found that the shielding properties of magnetic screens become much better as the frequency increases. A curve of this effect as given by him in the Journal of Telegraph Engineers of Nov. 8, 1883, is reproduced here in Fig. 4.

R. F. Shields

At radio frequencies, current sheets are limited to a very small depth of the shield, so a great thickness of shielding material is not essential.

From theory, then, we may conclude that perfect shielding is not possible, but that at radio frequencies, by choice of metals and thickness of shields, excellent magnetic screening may be obtained. It should be pointed out, however, that in designing radio frequency apparatus, one is mostly concerned with the electrical constants and effective resistance of the high frequency circuits. An insulated magnetic shield, or metallic mass, may not change the pure Ohmic resistance of a coil at radio frequencies, but they invariably change all other characteristics and constants of in-

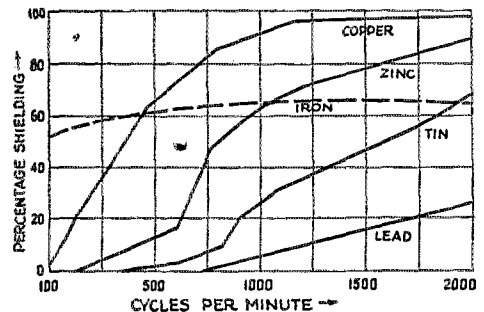

FIG. 4

WILLOUGHBY SMITH'S SHIELDING CURVES

ductors. The coil resistance will be increased by the resistance of the shield itself; moreover, if the shield becomes electrified by connecting it to a part of the electric circuit, particularly of the coil being shielded, there will be an increase of 5 to 500% of the effective resistance. This may be still larger at the highest frequencies. This is due to the much greater distributed capacity and its consequent parallel effect predominating at higher frequencies. A shield will permit magnetic action on a second coil, the action being a tertiary current as will be shown later. A shield or any metallic surface may even permit magnetic coupling between two or more in-

ductors, which of themselves may have theoretically zero coupling. The effect may be the induction of a potential displaced nearly 180 degrees from the potential desired, and as a result the effective potential is greatly reduced.² Undoubtedly the greatest effect may be attributed to the increase of

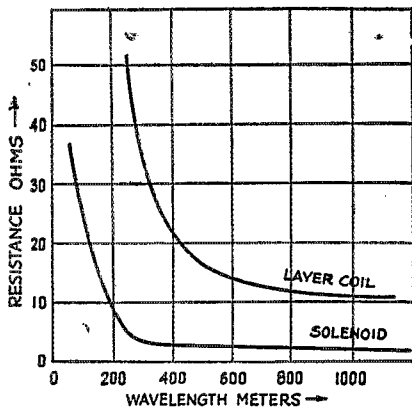

FIG. 5

RESISTANCE AT DIFFERENT FREQUENCIES OF A SOLENOID AND A COMPACT COIL

distributed capacity of the coil, this effect being of considerable magnitude in all cases, but is greatest when the shield becomes an electrode.³ Very often, unexpected changes of the coil constants may develop when the parts are mounted in the shielded cabinet. One unacquainted with the performance is certain to overestimate the importance of some theoretical loss, or perhaps pass over as negligible some effect that is of major importance. To know the exact importance of each theoretical loss one must resort to direct experiment.

In outlining the experimental work to follow, the negligible effects will be developed as fully as any other to enable the reader to estimate their importance for himself.

Because coils of different shapes must be considered later on *with* shields, it is convenient now to consider them alone—that is to say, without shields.

2. A good illustration of this is the thing that happens when one tries to shield a neutrodyne without thinking the thing over. Incidentally, a 4-stage neutrodyne is an amazingly difficult affair to get into proper operation. In those that are on the market circuit tricks have been used.—Tech. Ed.

3. That is when it is connected to one end of the coil. This of course includes the usual practice of "grounding" all the shields to the filament. As a rough working rule, when separate coil shields are used the best *inter-stage shielding* is gotten by letting the shields "float" free, while the best shielding against *pick-up of stations* is gotten by connecting all shields together, and to the filament.—Tech. Ed.

The Unshielded Coil

Many designers, in an effort to avoid "dielectric losses", have employed mass formations for the coil windings, and these assuredly have greater dielectric flux and consequently greater capacity by ten to five hundred times than if the wire were to remain a solenoid or equivalent coil over an insulating core of the same geometry. Single layer solenoids have a low capacity for a given inductance, hence, the coil fundamental being lower, a much lower wavelength is possible than with other coil shapes of equal inductance. Distributed capacity in a coil establishes an equivalent series circuit of low resistance in itself to free currents in it, but it gives practically an infinite impedance to potentials applied at resonant frequency to it. At frequencies anywhere near the coil's fundamental no sensible current may pass through the circuit, though there will be considerable current circulating within the coil, thereby wasting energy. Let us examine these effects and the distributed capacity of two different coil types. Two lengths of 22 D.C.C. copper wire are cut each 35 feet long. One is wound up into a solenoid; the other being into a multi-layer coil of square cross section. Each was designed to have geometrical dimensions giving the best coil

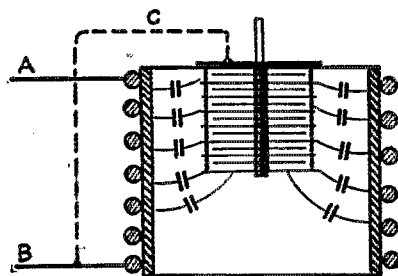

FIG. 6

EFFECT OF A VARIABLE CONDENSER INSIDE A COIL

The inductance is reduced and the resistance raised, especially when the connection C is made.

shape, that is, the greatest inductance for that length of wire used. The capacity, denoted hereafter frequently by the symbol C_0 , for the solenoid is 3.566 micromicrofarads while the multi-layer coil has 7.54 micromicrofarads. Now, the manner of current distribution in the two types is different and of course gives them different resistances, but greater than this is the effect of distributed capacity upon the resistance. The respective resistances of these two coils of equal lengths of wire and equal direct current resistance is shown in Fig. 5. We learn from this curve that the solenoid will tune efficiently with about 25

ohms at 100 meters, but the coil of higher capacity develops hundreds of ohms effective resistance at 200 meters which is its fundamental region and below which it cannot be tuned.

Condensers Near Coils

To demonstrate the changes of a coil's constants when it is associated with metallic bodies, several coils were made up for these experiments. One, (Fig. 21), a solenoid having dimensions and constants similar to those inductors employed in commercial re-

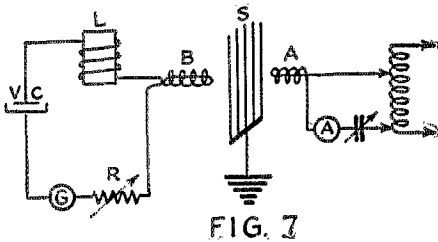

FIG. 7

MEASUREMENT OF COIL RESISTANCE

A vacuum tube oscillator puts a current of 2 amperes through the ammeter A and the coil 1. The wire screen S prevents static coupling and permits only magnetic coupling. L is the coil under measurement, B is a pick-up coil, R is a variable resistance. The circuit to the left is tuned to resonance by varying the low resistance condenser VC which consists of two brass plates, the upper suspended by silk cord. The capacity range is from 5 to 2000 micro-microfarads. When resonance is secured, resistance is cut in at R until the galvanometer G gives one-fourth of the first reading. The resistance R is then equal to the circuit resistance. The coil resistance is gotten by subtracting the resistance of the leads, galvanometer and the small coil B.

ceivers was selected to illustrate these phenomena. Its free constants are as follows: Length of winding 7.6 cms.; Diameter 13.2 cms.; 53 turns 22 D.C.S. solid copper wound on 3-ply paper tube thoroughly dried and bakelised. Pure self-induction 374.0 mhs; distributed capacity 4.400 μ fds. This solenoid was supported on an elevated granite slab; a 23 plate variable condenser provided with metal end-plates equipped with bushings was inserted into one end of the coil as shown in Fig. 6. This caused the capacity to increase to 9.052 μ fds. When both sets of plates are shorted and attached to terminal B as shown by the dotted line C; the capacity increased to 10.8 μ fds. Many other trials were made; the plates opened out etc., each giving some slight change of capacity. Now, according to theory, metal sheets, placed as the condenser plates are, should develop circular currents and cause a decrease of self-induction. In this experiment the self-induction fell from 374.0 to 336.1 mhs., and then further to 327.8

mhs. when the conductor became an electrode.³ The high frequency resistance of the inductor was next measured at a number of frequencies, the method being as shown in Fig. 7. The coil resistance was measured for the condenser in position as described above. At 1200 kilocycles this condenser, placed as shown in Fig. 6, increased the resistance from 30.5 to 38.5 ohms with the plates closed, but when the plates were opened, a resistance of 47.5 resulted—an increase of 26% and 56% above normal. At 500 K.C. it increased from a normal of 4.9 ohms to 6.6 and for the open plates, 7.7, which is respectively 16.3 and 34.8 percentage increase due to the larger distributed capacity and losses in the metal structure of the condenser body. Equipment with the condenser actually inside the coil is rarely constructed. To observe the effect of an isolated condenser near an inductor coil, a large Navy type commercial condenser weighing several pounds and of 2500 μ fds. capacity, was thoroughly insulated and placed in various positions about this same solenoid. There was no electrical connection with the condenser, therefore it did not become an electrode potentially, except for possible polarizing through static induction. At 1200 kilocycles the resistance is 30.5; and for 500 K.C. R. is 4.9 ohms. First the coil and condenser axis were parallel as shown in Fig. 8A, the separation between nearest surfaces being 0.6 cm., for which condition the resistance increased 38.5 percent to 42.28 ohms at 1200 K.C.; for 500 K. C. 41% to 7.2 ohms. Opening the plates caused no change of resistance. Since it was believed that static induction near the coil ends would here be considerable and thus increase the capacity, the surfaces were moved 3.5 cms. apart; six times greater. Then the increase was 35% and 14% for the two frequencies. In position

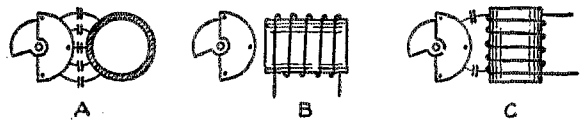

FIG. 8

VARIABLE CONDENSER NEAR A COIL

The position shown gave resistance increases of 27 to 63 percent. Greater spacing would have prevented this.

B, with a separation of 2.2 cms., the resistance is 38.7 and 8.3 ohms, or 27% and 63% above normal for 1200 and 500 K.C. This position showed a very small increase of capacity but the effect of eddy-currents was very great, probably taking place through the heavy tie rods and plates. For the position shown at C, with a spacing of 0.5 cm., the resistance was 38 and 7.2 ohms for 1200 and 500 K.C. respectively,

and by separating the units 3.5 cms. these became 38 as before for 1200 K. C. but 5.6 ohms for 500 K.C.

As a result of these and other tests it seems that the presence of variable condensers near an inductor increases the ef-

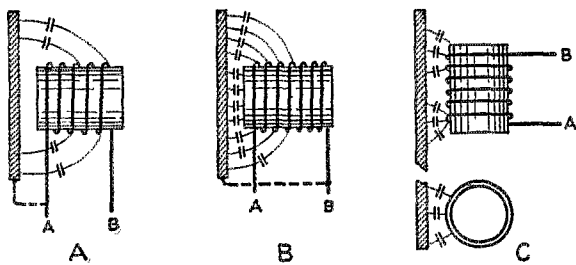

FIG. 9

EFFECT OF A SCREEN NEAR A COIL

Position A (one centimeter clearance) increased the coil capacity 25%. With the plate connected to the terminal A, the coil capacity rose a trifle higher. With the plate connected to the terminal B, the coil capacity increased 486% and the fundamental wavelength rose from 76 to 186 meters. Position C (one centimeter clearance) gave small increase of capacity unless either terminal of the coil was connected to the plate when the capacity rose about 300%.

fective resistance and that this is largely due to an increase of coil capacity. Should the condenser form one electrode, as it generally does, the high potential portion of

the coil develops an additional dielectric flux in space to the metal producing a stray field acting in addition to the simple capacity, thus forming a component which may be much greater than the coil capacity itself. Such a stray field is shown at A in Fig. 8. Such strays as we have just shown are not serious for the solenoid, but they are enormous for flat spirals, and are less so for coils of rectangular cross section. The arrangement at B proved to gain the least capacity and resistance, and if the near terminal connects to the metal plate there will be much less effect on the capacity and resistance than any other arrangement. However, in any position there will be circular sheets or loops of metal which tend to reduce the self-induction, and in this respect, the arrangement of Fig. 8A gives the least change of self induction. By removing the condenser two inches from a solenoid, there will be no great change of any coil constants. Since there is a great reduction of the self-induction where the metal plates intercept the coil axis, a sufficient separation should be made to prevent such reaction.

Shield Near Coils

Let us examine the effect of a metal sheet near an inductor coil. A brass plate 10 by 12 inches and one eighth inch thick is supported on an insulated frame; then the same solenoid is placed 1cm. from the plate surface—Fig. 9A. For this position C₀ increased from normal 4.40 μfuds. to 5.48—about 25% increase. Although the plate is isolated from the coil and does not form an electrode, it has position permitting static induction through it. A re-distribution of the current, of shifting of the current node, undoubtedly takes the place also, causing a variation of the coil's normal free constants. The brass plate was next connected to coil terminal A as in Fig. 9A, C₀ increased more to 5.9 μfuds. The plate now has the same potentials as the near-end, of the coil but is far removed from the opposite potential end, hence the increase is slight; but, by connecting the shield plate to the terminal Bias shown in Fig. 9B,

the coil end adjacent to the brass plate, acting through a very short distance, permits a much greater concentration of dielectric

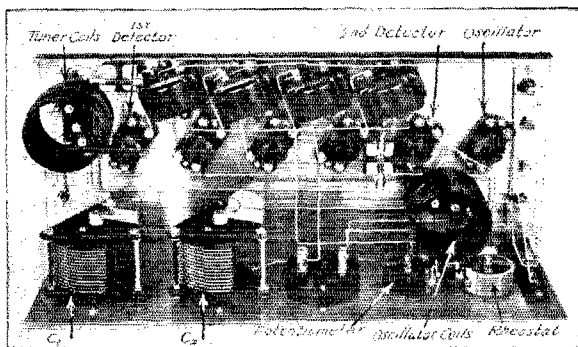

A SUPERHETERODYNE RECEIVER SHOWING PARTIAL SHIELDING

The base and panel are of a single sheet of brass, which provides a "ground voltage plane" to which one terminal of each piece of apparatus may be connected so as to keep down capacity couplings. With this precaution the set is very stable while without it the operation is decidedly tricky. The intermediate frequency transformers (General Radio) are individually shielded against magnetic and static pickup by means of closed magnetic cores and closed brass shells. Coupling between the oscillator coils and the tuner coils has been reduced by wide spacing instead of shielding. This set was described in August, 1924, QST.

flux—far greater than was present over the free coil itself—and this increased the capacity to 214 μfuds or 486 per cent above normal and raised the fundamental from 76 to 186 meters—for a solenoid, which is so often thought of as behaving perfectly at all times! We observe that several effects are

negligible while one is of considerable importance.

With the coil axis parallel to the plate, Fig. 9C, the instantaneous potentials distributed over the coil surface will develop greater density near each end, but the potential acts from a series of arc-shaped electrodes and from the nearest parts of the coil, so the increase is small for the isolated sheet, but when the sheet is connected to either terminal of the coil, C_0 increased to 12.94 $\mu\text{fds.}$ This is about 300 percent, and since either coil terminal is located at 1 cm. from the plate, C_0 is the same with either terminal connected to the plate. This position is very frequently employed in shielded circuits. The increase is large when the metal has an electrode potential relation to the near portion of the coil. Frequently there may be capacity effects which permit reaction with another coil or part of the circuit, the reaction being due to static induction.* Such effects as have been mentioned may be reduced by moving the shield to a greater distance and by properly orienting the coil with respect to the shield or other metal parts.

One can reason the probable effect of different types of coils where a shield is introduced. If the sheet of metal is located so that dielectric lines cause high induction in it, the flux density in the space between the coil and sheet is according to the distance through which the induction flux acts. If the sheet is placed along the coil axis so that the magnetic flux extends

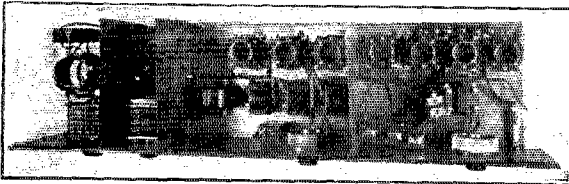

A SUPERHETERODYNE EMPLOYING MORE COMPLETE SHIELDING

Sheet copper lines the panel, the box and the base, all parts being connected when the box is in place. This lining, together with the three metal partitions, divides the entire set into 4 compartments. The one to the left contains the oscillator, then in turn come the 1st detector, intermediate frequency amplifier and the 2nd-detector-plus-audio. The individually shielded I.F. transformers of the General Radio Co. are employed here also. Built by John M. Clayton of the QST staff for Mr. Murphy of the Hartford Times.

through the plane surface, then, during transient periods, there will be currents generated in the metal, causing an energy loss in the sheet—usually small—and a reduction of the coil inductance.

The Pancake

To illustrate: A perfectly flat spiral of 220.4 mhs. inductance; 41 turns 22 D.C.C. solid round copper wire wound 17.4 cms.

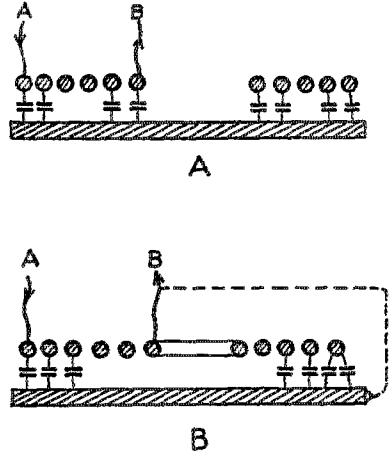

FIG. 10

PANCAKE COIL AND SHIELD

Arrangement A increased the capacity 790%. The dotted connection of B reduced this to 608%. The inductance decreased 60%.

diameter and has 3.10 $\mu\text{fds.}$ capacity. Now, from theory, with the metal shield plate isolated, and due to the nature of such flat fields, we should expect a great change of the coil's constants, for all points of the winding are equidistant from the plane surface of the shield. Hence the dielectric field becomes very dense as shown in Fig. 10A and for this coil separated 1 cm. from the plate, the capacity became 24.50 $\mu\text{fds.}$ which is 790% greater than normal. Here is an effect entirely different from that of other coil shapes. By connecting one terminal of the coil at A to the metal plate, instead of increasing the capacity, it is actually decreased. In Fig. 10B, the plate near the coil center acquires the same potential as the central area of the coil, hence the dielectric flux is dense only near the coil edge, and C_0 fell to 18.62 $\mu\text{fds.}$ which is still 608 percent above normal. Other coil shapes experienced an increase of capacity when connected to the plate, but for the spiral, making one terminal connected to the plate, actually reduces the capacity gain caused by the plate. This is generally the case where the spiral is close. For the self-induction: it

4. Unfortunately the detailed discussion cannot be reproduced.—Tech. Ed.

decreased from 220.4 to 88.6 mhy. at 1 cm.—a decrease of 60 percent. Such effects as this make it difficult to place great reliance on spirals.

The Compact Coil

For a coil of rectangular cross section, the dielectric field is almost entirely within the boundaries of the coil, giving to this type an inherently large distributed capacity and making it rather undesirable for precision work. Though such coils have the least ohmic resistance for their inductance their

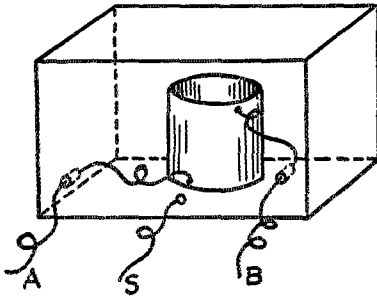

FIG. 11

TEST COIL COMPLETELY SHIELDED

large capacity gives them a very high effective resistance. Since the dielectric flux is mostly within the coil, it does not suffer any great increase of capacity by the presence of the shield. To illustrate: A small 100 turn "honeycomb" coil has 8.41 μ fds. capacity and 566.8 mhy. inductance, but it showed no change of capacity when the coil was 1 cm. from the plate. The self induction, however, decreased 12.5 percent, becoming 495.8 mhy. By connecting one coil terminal to the plate, C_0 increased 204 percent to 17.12 μ fds. Thus we find from theory and experiment that the compact coils perform very well in shielded circuits, probably more constant in their behavior than solenoids or spirals of equal inductance, and in this comparison, the geometry of the coil is an important factor (Fig. 17).

Closed Shields

To demonstrate the effect of completely shielded inductors, two boxes were made; one being 12 x 10 x 9 inches; another being smaller, 8 x 8 x 5 inches. These boxes were thoroughly dried and coated inside with shellac and lined with heavy lead foil 0.01 inch thick. All joints were made secure and covers with an overlap were provided. In theory lead becomes a fair screen at very high frequencies, but it is apparent from experiments that its efficiency at radio frequencies is below copper and other metals

of good conductivity. Changes of the dielectric effects and the effective resistance were measured by placing the coils under test in the exact center of the boxes. Termi-

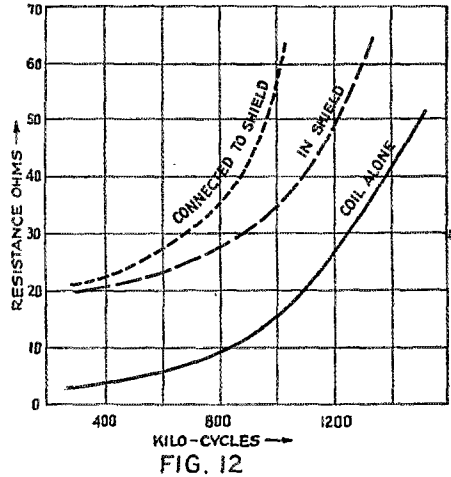

FIG. 12
EFFECT OF LEAD SHIELD 1/100 INCH THICK ON RESISTANCE OF A SOLENOID

nals through tubular insulators connect to external apparatus as shown in Fig. 11. The solenoid described above was placed in the smaller box and the metal shield insulated from the coil; this increased the

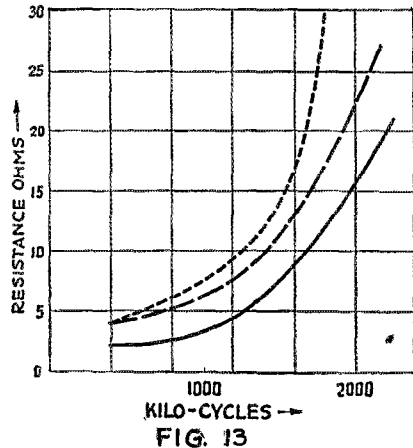

FIG. 13
RESISTANCE CURVES FOR A MORE COMPACT COIL THAN THE ONE USED FOR FIG. 12

Note that the resistance is not increased so much because the field is not so large.

capacity from its normal of 4.40 to 4.66 μ fds., but the self induction fell from 374.0 to 280.2 mhy. Then, by connecting the

shield to the coil terminal A, the capacity became 34.2 μ fd., which is 778 percent increase and is much greater than for the shield of brass, although that plate was much closer to the coil. By connecting the terminal B to the shield, C, became 13.61

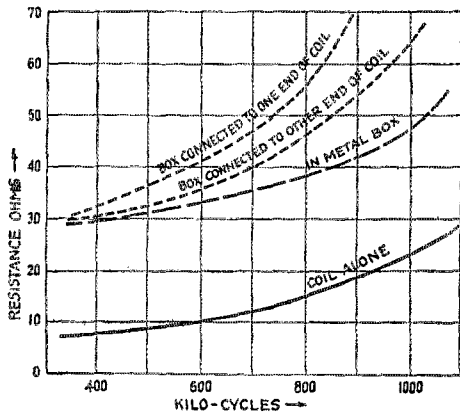

FIG. 14

EFFECT OF SHIELD ON THE RESISTANCE OF A PANCAKE COIL

Note that the increase due to the shield is very large but that the additional increase by connecting the coil to the box is about the same as for the solenoid of Figure 12.

μ fd., which is 310 percent above normal. Since the box was smaller than most radio cabinets, the larger shielded box having about the same dimensions as the average cabinet was next used. For the same coil the pure self-induction fell to 344.8 mhys., a decrease of only 8 percent, while the capacity became the same as for the brass plate, 4.66 μ fd., but with the terminal A connected to the metal lining, the capacity became 26.56, and for the terminal B, 22.2 μ fd.—showing by experiment that the effects of completely enclosing a coil is to increase the capacity more than for a simple plane sheet. This is particularly true when the shield forms (by contact or through induction) an electrode with respect to the coil.

High frequency resistance of the coil was next measured at several frequencies, the curves being shown in Fig. 12. The sudden increase of the dash curve with respect to the solid line curve indicates the effect of currents in the shield, for (as we have shown) the distributed capacity for the dash curve was only very slightly more than normal.

The curves of Fig. 13 show the effective resistance of a much smaller shielded coil (Fig. 22) of 118 mhys., the winding being 9 cms. diameter, 4.8 cms. length, 35 turns 22 D.C.C. copper wire wound as a solenoid

The capacity for the free coil is 4.859 μ fd., such a coil compares with the antenna coil coupler primary of broadcast receivers.

Curves in Fig. 14 show the effective resistances of a flat spirial which was wound in a slotted disc of fibre; self-induction 442.6 mhys.; diameter 12.6 66 turns of 26 D.C.C. solid copper. Normal capacity is 5.427 μ fd. The increase of the dash curve is largely due to the effect of currents in the shield. However, by connecting the shield and one coil terminal together, we see an immediate and very sudden increase of resistance for frequencies above half million cycles. This is clearly the effect of capacity in suddenly increasing the resistance at higher frequencies, and we know from the preceding that the capacity is greatly increased by making the shield an electrode. The energy loss in imperfect shielding material is apparent. Starting at very low frequencies it continues of first importance until the stray and distributed capacity reactance of the coil component becomes sufficiently low at higher frequencies, creating a parallel effect approaching resonance, thus raising the resistance more rapidly thereafter. This phenomenon is identical for copper shields but the increase (due to currents) is not of such magnitude, as will be shown in Fig. 16.

There is an energy loss here having some function of the frequency, which loss, due to the mutual magnetic action between the systems, becomes an attribute of the primary coil itself.⁵ This loss may be serious in de-

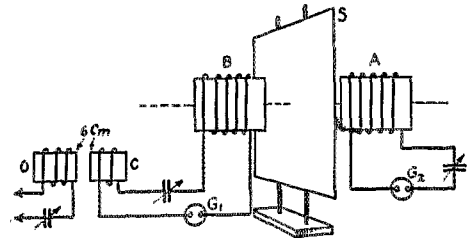

FIG. 15

SHIELD MATERIAL TESTER

The coil C is in the circuit of a vacuum tube oscillator. It is kept 6 centimeters from the coil C to prevent static coupling as far as possible. The coil C together with B and the series condenser are tuned to resonate with the oscillator. Energy from B is transferred magnetically to the coil A which is tuned to resonance by means of a variable condenser. The current flowing through the galvanometer G is an indication of the leakage through the shield S. Different shields are tested by putting them in the same position.

effective shields as we have shown. Where shields are resorted to for confining the static component, careful choice of the

5. The effect is exactly the same as if the primary coil had higher resistance. This is the familiar transformer effect in which load on the secondary acts as a load on the primary.—Tech. Ed.

metal surfaces should include consideration of the magnetic component to which the shield will be subject. Static screens may

be of perforated mesh-work, but losses in such shields would be very large.⁶ In these experiments the writer used

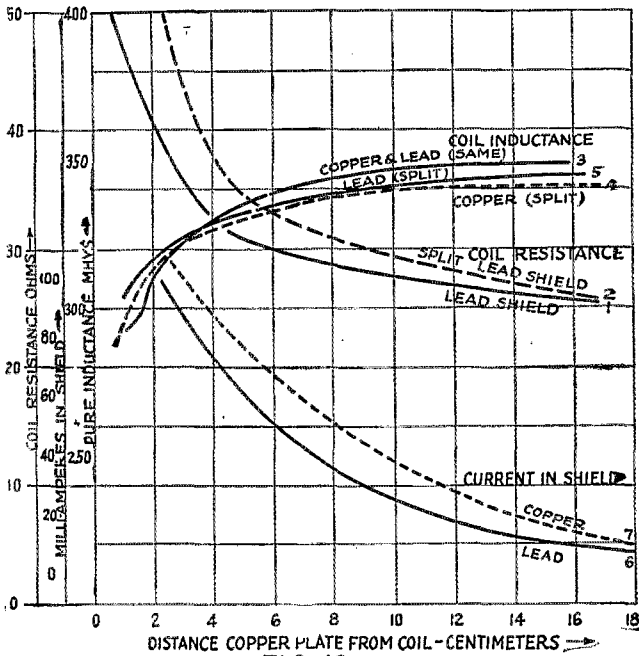

FIG. 16

CURVES OBTAINED WITH THE APPARATUS OF FIG. 15 AND THE MODIFICATION OF FIG. 19

The currents in the secondary circuit A are not considered as they are described in the text.

- Curve 1. Resistance of B for lead-foil shield.
- Curve 2. With the same shield split as in Figure 19B.
- Curve 3. Inductance of coil B with copper and lead shield.
- Curve 4. Inductance of B for copper shield split as in Figure 19B.
- Curve 5. Inductance of B for lead shield split as in Fig. 19B.
- Curve 6. Milliamperes in copper shield when split as in Fig. 19B.
- Curve 7. Milliamperes in lead shield when split as in Fig. 19B.

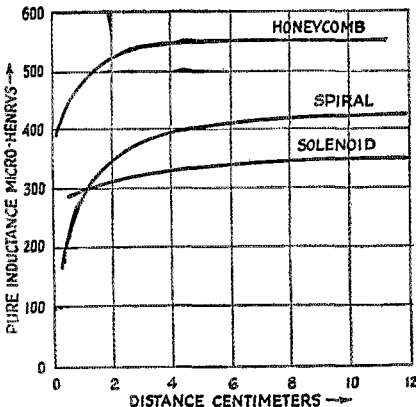

FIG. 17

CHANGE OF INDUCTANCE FOR DIFFERENT COILS AT DIFFERENT DISTANCES FROM SHIELD, THESE ARE THE COILS OF FIG. 15

copper, brass, aluminum and lead surfaces of similar dimensions. Copper and lead-foil of the same thickness were selected to show the extreme effects.

A sheet of commercial copper 0.011 inch thick was cut 15 by 15 inches square and supported by insulators upon a wooden laboratory stand as shown in Fig. 15 at S. A sheet of lead foil of the same dimensions was stitched to a sheet of bristol board which had first been dried and treated with shellac.

6. Special screens of this type have been used successfully by the Western Electric Company in connection with high-power vacuum tube transmitters for shipboard use. The sets were surrounded by heavy copper sheets punched full of rectangular holes so as to result in a sort of coarse screen. The losses in these sheets were much less severe than the losses which would otherwise have taken place in the steel-work of the ship.—Tech. Ed.

Since the currents will supposedly be different in the shields of such different conductivities as lead and copper, the reader will suppose that there will be a dissimilar variation of self-induction for the two sheets, even though they may have identical position. Such variations of pure inductance for lead and copper actually are shown in Fig. 16, hence the conductivity of the metal is another factor as predicted from theory.

To demonstrate the comparative change of self induction for several field shapes, a solenoid, spiral and multi-layer coil of approximately equal inductances were separately placed at various distances before the copper plate and measured at 500 K.C. for pure inductance. These characteristic coils are typified by the sketch in Fig. 18; the variation of inductance with distance is shown in Fig. 17. As expected from theory outlined before, the solenoid showed little change of inductance though very close to the plate, for in this coil type, there are many leakage lines. On the other hand, we

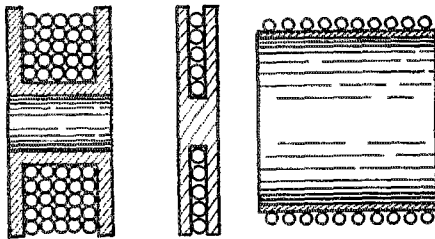

FIG. 18

COILS USED TO OBTAIN CURVES OF FIGURE 17

find a rapid change for the spiral, (which was a spider-web coil). The spiral turns, all being equi-distant from the plate, permit a very rapid decrease, becoming nearly zero inductance when the coil is separated only by its insulation from the plate. In fact such a coil may be closely tuned over a considerable range of inductance, functioning much as a variometer, by moving a metal disc to or from the coil. Some such new tuning device may pop out any time as a "low-loss" variometer! The multi-layer coil is midway between the spiral and solenoid as may be seen from Fig. 18.

Shield Size and Spacing

To demonstrate the effectiveness of magnetic shielding, two identical coils (Fig. 23) were made up; inductance 189.5

mhy., diameter 10.6 cms., length winding 2 cms., 37 turns 23 D.C.C. solid copper. These coils appear as A and B in figure 15. Coil B was placed on one side at the exact center of the copper shield and was energized by the oscillator which was coupled to it by a small

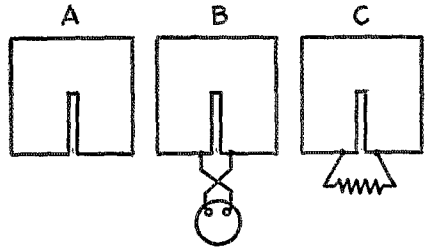

FIG. 19

SPLIT SHIELD USED IN OBTAINING CURVES OF FIGURE 16

coil of 4 turns at C. For 500 K.C., current in the coil B was 300 milliamperes. Coil A was placed along the same axis but immediately on the other side of the shield, the windings being only 1.7 cm. apart; the coil A was tuned by a condenser and currents read on a sensitive meter G₂. The lead foil shield was inserted at S, exactly between coils A and B. When returned to resonance, 300 milliamperes in the circuit B generated 44 milliamperes in the circuit A, showing that the coil was imperfectly shielding the coil A. Then the copper sheet was inserted between the coils, and when returned, 300 milliamperes in B gave only 1.8 milliamperes in the coil A, or less than six-tenths of one percent of the induction current was generated in A—this for two coils less than an inch apart showing the high efficiency of good copper as a shield. Other plates of smaller area permitted greater current in the coil A, and to demonstrate the theory of areas on a small scale,

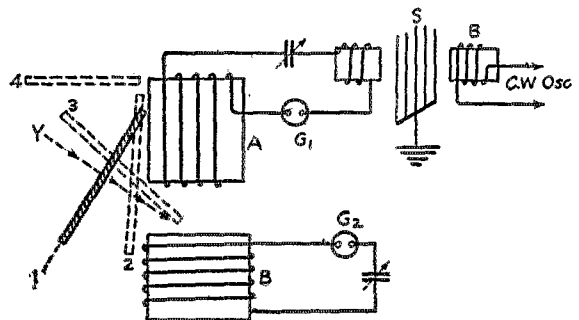
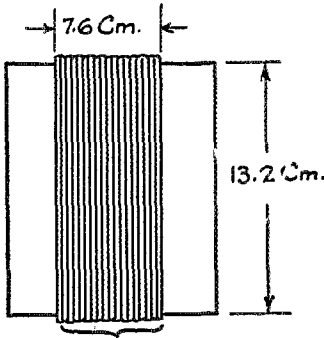

FIG. 20

EXPERIMENTS ON DISTORTION OF FIELDS BY SHIELDING
Excepting for the position of the shield and coil B the apparatus is the same as that of Figure 15.

a plate of aluminum 10 by 8 inches 0.016 inch thick gave 45.5 milliamperes in A, and for a thicker plate 0.064 inch thick, 46.2



53 turns 20 D.C.C.

FIG. 21

Coil used in Figs. 6A, 7, 8, 9, 11, & 12
374 Millihenrys. 4.4 Micro-microfarads distributed capacity

milliamperes, although aluminum in areas 15 by 15 inches, the same as the copper, gave nearly the same efficiency as copper as a shield. Now, moving the coils 12 cms. apart, the copper sheet being mid-way be-

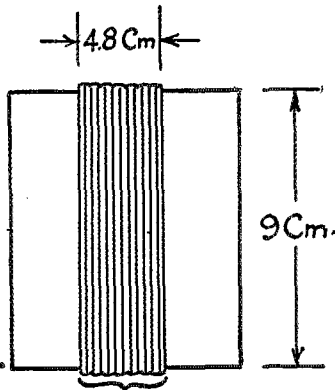

35 turns No. 22 D.C.C.

FIG. 22

Coil used in Fig. 13
118 Millihenrys
4.8 Micro-microfarads distributed capacity

tween them, 6.3 milliamperes were developed in A where it was 1.8 before. Though the separation was increased 8 times, the cur-

rent increased in A, and it continued to increase until 20 cms. distant from B, showing the shading effect of the shield and the leakage about the area used. It seems that a thickness of more than 0.02 inch, (24 B. & S.) does not better conditions, and that completely enclosing a coil improves the efficiency so far as actual leakage is concerned. To show the effect of reducing the areas and shield currents to component parts, a narrow strip of metal was removed from each sheet as shown in Fig. 19 at A. The combined effects of several of these tests is shown in Fig. 16 with description appended.

Field Distortions

In shielded apparatus it is frequently impossible to obtain zero coupling between two

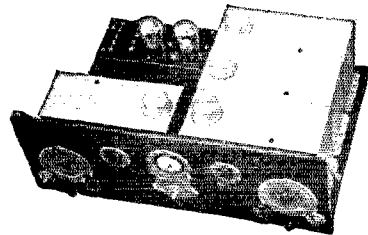
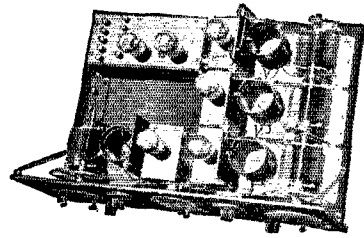

Photo courtesy Stromberg-Carlson Tel. Mfg. Co.

A BEAUTIFUL EXAMPLE OF A TYPE OF MODERN RECEIVER EMPLOYING THE PRINCIPLES OF R.F. SHIELDING WHICH ARE DISCUSSED HERE

The upper view shows the set with the separate metal covers removed, leaving only the base and panel shielding and the partitions between units. At the right are the three stages of tuned R.F. amplifier, operating from a common control. At the left front is the detector with its tuned input circuit, and behind that is the unshielded audio amplifier. The lower view shows the covers in place, each being equipped with a round "manhole" thru which tubes can be exchanged.

inductors. Although a direct interlinkage of flux between coils may be zero and theoretically prevent electro-magnetic induction, there may be interlinkage from another generated current, the flux of which may approach from another angle. To illustrate this the following experiment was performed: apparatus was set up as shown in Fig. 20 where the coils A and B are the same as used in Fig. 15. The current in the

coil A was 250 milliamperes, and the second coil B, 3 centimeters from A, was adjusted until the flux cut both arcs of the coil at precisely the same instant, hence, opposing potentials are equal and opposite in either half of any one turn, and the coupling was zero as indicated by the meter G. A brass plate 6 by 4 inches and one eighth inch thick was placed before the coil A, the plate having its plane along the line numbered 1 in Fig. 20. Both circuits were returned to resonance—there being a mutual decrease of self-induction—and a current of 26 milliamperes was generated in B.

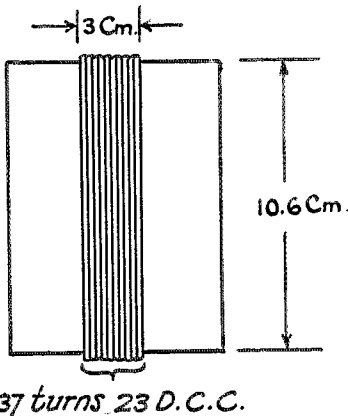

FIG. 23
Coils used in Figs. 15, 16 and 20.

Currents in the plate generated by the coil A develops a flux which approaches the coil B along a front Y, dephasing the potentials of the two coil arcs and produces a current in B which before had zero coupling with coil A. Along plane numbered 2, current in B was 9.5 milliamperes; along plane 3 it was only 2.5; and along the plane 4, current in B was again zero. Retuning was, of course, necessary for each case. The plate was 5 inches from the nearest part of the coil B when along panel 1, and it is apparent that this angle permits mutual interlinkage between the plate and each coil; therefore, currents in B in such cases as these are tertiary currents.

The results outlined here may enable the reader to form some idea as to the effects experienced from day to day. Too often we find a negligible loss dragged out as though it were of major importance, while really serious losses, which usually are secondary effects, remain obscure. To show them as they are has been my purpose in this article. We are able to calculate with fair precision the inductance of coils and how they should function, but we must realize that precise-

ly designed circuits are subject to variations, the magnitude of which is quite incalculable where we are limited to geometrical dimensions only. Probably effects such as we describe can be anticipated by having a fair idea of their importance, and a consideration of magnitudes and methods of design may be had by a careful application of theory and experiment, or by the more common process of happy guessing.

A Low Capacity Variable Condenser

A VARIABLE condenser of quite low maximum capacity, and of low loss construction, finds its place in a variety of receiving circuits. For balancing R.F. amplifiers of the neutrodyne type it is vastly superior to the spaghetti insulated rod type that has been in vogue for a long time. As a vernier to a larger main condenser it is essential that the losses in the small condenser must be at a minimum. When used as a series condenser, coupling the secondary of a ham receiver to the antenna, the condenser must have a low maximum capacity and should be of low loss construction. In any of the above places it is essential that the "midget" condenser be ruggedly constructed so that its calibration can be accurate. The General Radio type 368 micro-condensers fills all of these needs. It is a five plate baby 247 with the familiar soldered-plate hard-rubber-end-piece construction found in the larger type. It is arranged for either single hole panel mount-

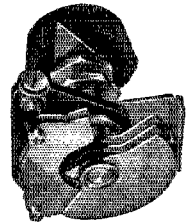

ing or for baseboard mounting, the latter being accomplished by means of a small, but accessible, bracket. The plates are larger than those of the usual "midget" type and the spacing between plates is greater than is usually found. The maximum capacity of this condenser is around 12 μ fd. which is ample for all purposes.

—J. M. C.

Volume IX Index

ALL League members should have received a copy of the index to Vol. 9 (complete 1925 series) of QST with their February copy. If not received, kindly let us know and copy will be sent at once. Newsstand readers can obtain a copy upon receipt of 4c, stamps accepted.

—D. H. H.

Multiplex Short Wave Reception

By J. K. Clapp*

THE common use of the fixed tune antenna circuit in amateur reception permits the use of multiplex reception under relatively simple conditions. Several receivers may be used on a single antenna, and even with the same "A" and "B" batteries. If the receivers are operated in different wave bands the only time mutual interference will occur is when one receiver is tuned to a multiple of the frequency of one of the others. Under actual operating conditions, with each of the receivers in its most sensitive adjustment, the amplitude of the harmonic signal will be much less than that of incoming signals.

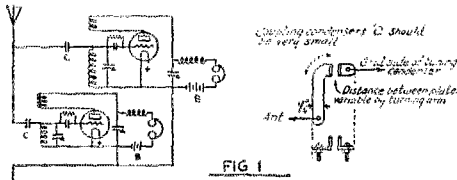

In listening, the effect is that of running onto a broadcast transmitter harmonic which is quite feeble compared with the signals coming in. If the regenerative control of one of the receivers is set so that that receiver generates very powerful oscillations, then the harmonic heard on one of the other receivers will be quite loud for the second harmonic, of medium strength for the third harmonic, and weak for harmonics of higher order.

If apparatus is available for setting up two complete receiving sets, with the exception of the batteries, then a simple duplex arrangement may be made as indicated in Figure 1. Where plug-in or otherwise interchangeable, coils are used, each receiver may be adjusted for operation on a given waveband. Operation may readily be carried out in the same waveband, if desired, as long as the two receivers are not "crossed" by attempting to receive on the same wavelength. Using separate headsets, two operators may receive on two wavelengths with complete independence. Where there is only one operator, as is usually the case in the average amateur station, a split-headset should be used. In this case, each phone is provided with a separate cord, one receiving set being connected with one head-phone and the other receiving set with the other. If one receiver set is on the eighty-meter band, and

the other on the forty-meter band, for example, simultaneous observations on these two wavelengths may be made.

A very little apparatus will provide a switching arrangement for changing the headphones around, giving simplex reception on either wave with both headphones, or duplex reception with one phone on each of the receiving sets. A handy way of doing this is to provide each headphone cord with a plug, and each receiver with two short-circuiting jacks, as indicated by Figure 2. Plugging both headphones to either receiver gives normal simplex operation, while plugging one headphone on one receiver and the other phone on the other, gives duplex operation. This arrangement also allows of interchanging the receivers and phones on duplex, changing over from say eighty meters on the left phone and forty meters on the right to eighty meters on the right phone and forty meters on the left. There is sometimes a very definite advantage in being able to accomplish this change, if the operator's ears give better reception on one side than the other.

A handier method for quick shifting is to make use of jacks with dummy plugs, or

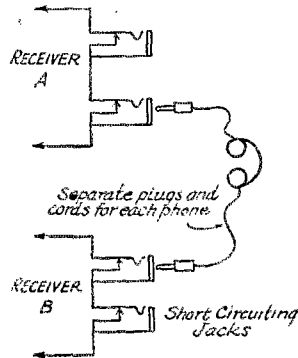

SIMPLE PLUG-JACK TRANSFER
DUPLIX - TWO PHONES

FIG. 2

"jack switches," or telephone key switches. With these a switching arrangement for transferring the phones between two or more receivers is easily made, as indicated in Fig. 3. This shows a means for listening in duplex on any combination of four receiving sets accomplished by throwing the switches in the vertical bank to the left in the proper order: and for listening in simplex on any one of the four receivers with both of the headphones in circuit in

*Instructor, Communication Division, Electrical Eng. Dept., Mass. Institute of Technology, Cambridge A. Mass.

series, by throwing the proper switches of the vertical bank to the right, as "A-A," after which switch "A" chooses between the receivers 2 and 3, as desired, transferring both phones of the headset in series. All switches should be open when idle.

It is of distinct advantage to have the receiving sets made up with a common mounting system for the coils; then by having tuning condensers of different sizes in the different sets, good operation may be obtained on each of the wave bands, using a single set of coils. For example, the author uses three receiving sets having tuning condensers as follows:

4,997 to 1,449 k.c. or 60-200 meters	250 μ fd.
11,990 to 2,998 kc. or 250-100 meters	100 μ fd.
? to 23,980 k.c. or below 50 meters	50 μ fd.

The first of these is a standard make of condenser having 13 plates; the second a nine plate condenser of the same make, but with double spacing; the third, is of five plates with double spacing. The coils used are $3\frac{1}{4}$ inches in diameter for the tuning coils; $1\frac{1}{2}$ inches in diameter for ticklers. Each secondary coil is mounted on a strip of insulation carrying four General Radio Company coil plugs. The plugs are four-in-line, the outside plugs connecting to filament and grid terminals of the secondaries. The inside plugs are connected to the plate and B plus terminals of the ticklers, and

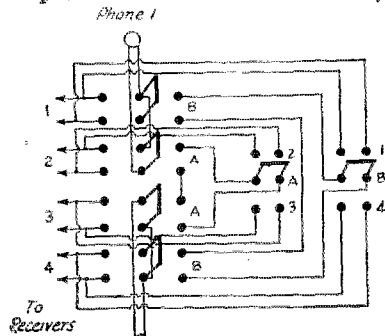

FIG. 3
SWITCHING SCHEME
QUADRUPLEX-TWO PHONES

the ticklers are permanently mounted in the center of the secondary coils. The coils may then be plugged in "either way to"—it makes no difference. (See Fig. 4.) In this manner a single transfer of coils places the receiver in operation on a new wave band, as the tickler is transferred with the secondary. Using a set of coils of two, three, four, five, eight, fourteen and twenty-eight turns for secondaries, all wavelengths between 12 and 200 meters may be covered, with *real tuning* on each wavelength.¹

The sizes of the ticklers must be adjusted to fit the set and tubes used—they will run from five to fourteen turns.¹ Using the circuit indicated in Figure 1 in the receiver, oscillation on the lower half of the dial of the tuning condenser, but not on the upper half indicates the tickler is too small; howling on the lower half indicates too large a tickler. The remedy is obvious. Proper adjustment of tickler turns will

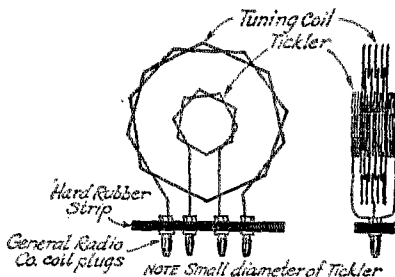

FIG. 4 REVERSIBLE PLUG-IN COIL SYSTEM

give oscillation over the entire dial of the condenser with either UV-199 or UV-201A detector tubes, using a 500 μ fd variable throttle condenser.

With this arrangement, using the four-turn coil on the "short" wave receiver, the eight-turn on the "medium" and the fourteen-turn on the "long" wave set, the following wavelengths are covered, immediately upon throwing a switch to light the tubes:

- 16,660 to 12,490 k.c. or 18 to 24 meters.
 - 9,672 to 5,879 k.c. or 31 to 51 meters.
 - 6,119 to 2,221 k.c. or 49 to 135 meters.
- Other combinations are obtainable by changing the coils in one or more of the receivers.

Traffic Improvement

The use of multiplex receiving equipment will become of more and more importance in traffic handling. By "standing by" on, say, eighty meters, a receiving operator having just taken a long distance message on, say, forty meters, will have a good knowledge of who may be working on eighty meters for relaying the message. With a wave change transmitter, shifting to eighty meters will then be quickly and easily done, and a call put through for a *definite* relay, not a long winded "CQ CQ CQ hr tlc fr Oshkosh p se QSR." The long distance, forty-meter hook, which is now loaded with a bunch of dead messages that were never cleared to stations within two or three hundred miles, will cease to exist. Praise be!

1.—If the series condenser is kept small (as sketched) the differences in tuning on various antennas is practically negligible, amounting to less than 2 divisions change on the tuning condenser for change from twelve-foot to one hundred-foot antenna. No trouble has been experienced in keeping the receiver oscillating with various antennas, using the fixed ticklers described.

Radio Surveys

For the experimenter, multiplex reception opens an extremely interesting field. Observations as to distances covered, fading, signal strengths on different wavelengths, etc., are made under conditions which approach nearer to the ideal. Listening simultaneously on eighty and forty meters, at various times of day, under varying weather conditions and so on, we are able to get definite information as to which of the wavelengths gives the best reception over given distances. In this manner it has been observed by the writer that under favorable conditions reception on eighty meters comfortably overlaps the skipped distance on forty meters; for example, the eighty meter signals will be heard over distances averaging up to 1,000 miles at times when the forty-meter signals average down to 300 or 400 miles, but not less (except for stations within a few miles.) Similarly, on rainy, cloudy days or nights, it has been observed that the eighty-meter signals are much nearer normal than are the forty-meter signals, and in some instances are distinctly better. Information of this kind is what is needed to make use of the present amateur wave bands in an efficient manner both for traffic and experimentation.

Wavemeter Work

Another use to which a multiplex receiver may be put is that of checking wavemeters, particularly on standard frequency signals. One receiver is reserved for use in tuning in WWV (for instance) on his fundamental; the other, or others, are used in picking up the harmonics of this first receiver. If the settings for WWV and say the second and third harmonics are approximately determined beforehand, it is easily possible to obtain three times as many points on the wavemeter calibration as there are frequencies sent out in the standard frequency transmission. The receiver which is tuned to WWV is made to beat zero, or a very low beat, and a second receiver is set to beat zero, or a very low beat, with the second or third harmonic. Bringing the wave-meter near *either* receiving set will produce a shift of the beat tone at resonance at the fundamental or the harmonic. If the coupling is kept at as small a value as possible without losing the shift in tone, it will be found possible to hold the receivers within 200 cycles or so of the exact frequency, and still obtain a definite indication on the wavemeter.

For the short wavelengths this represents an accuracy which is beyond the accuracy of the wavemeter. In fact, with most wavemeters more than sufficient accuracy is obtained if the beat tone stays *within the audible limits*, for the 50 to 100 meter standard signals. By using the third

harmonic it is possible to check a wavemeter down to approximately 16.7 meters, thereby including the twenty and forty meter bands, which otherwise one cannot directly check against WWV.²

2.—And that, by the way, is a grave defect in the otherwise splendid service from WWV.—Tech. Ed.

Novel Straight-Frequency-Line Condenser

GOING at the problem of a straight frequency line condenser in an entirely novel fashion, the Allen D. Cardwell Company have developed a condenser that is decidedly different. Instead of performing the usual stunt of making the condenser plates some shape other than semi-circular they have gotten a straight frequency line type out of semi-circular plates. The plates are made wedge shaped, being very much thicker at one end than at the other. Both

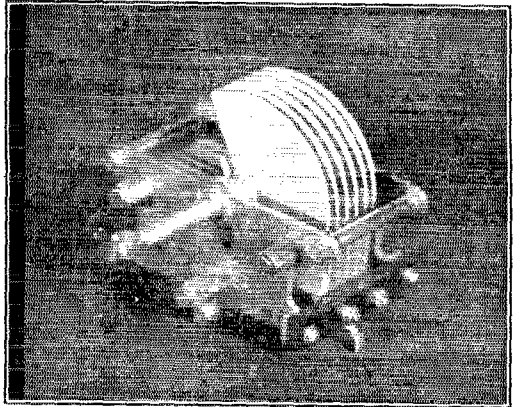

rotary and stationary plates are shaped in this manner. In addition to a straight frequency line, construction of this type results in one of the solidest jobs we have ever seen. The plates are of cast aluminum fitted in the well known Cardwell fashion. The condensers are the same size (physically) as the other models brought out by this Company. They are interchangeable with the older types in any set, and are made in a variety of capacities.

—J. M. C.

Strays

9ZT suggests that some energetic ham printer ought to get up a "number sheet" for transmitted messages and give them away to hams. The sheet could have the printers advertisement on it stating his price for QSL cards, etc. The sheet would be sticking around in the shack where the ad would do some good. Sheets like W. U. Telegraph Company's would be the berries.

The Old Reliable

AFTER describing various leading types of the more complex receivers this magazine finds that there is still a steady demand for detailed instructions in building "The old Reliable" set using two stages of audio amplification after a regenerative detector.

Just *why* the home builder should want to make his own tuner unit is a bit puzzling. Excellent tuner units for the broadcast range have long been available. Since Assistant Technical Editor Clayton described the "plug-in coil receivers" in our August issue, such coils also have appeared in commercial form. One must therefore assume that the continued interest in building one's own tuner complete lies in personal satisfaction rather than economics.

At any rate, here is a fully detailed description of a really good broadcast receiver of the "old reliable" type. It can be built with an absolute minimum of tools and experience. The story is reproduced here thru the courtesy of *On the Air*, the text having been somewhat shortened and several illustrations added.

A Modern Regenerative Receiver

By Felix Anderson*

I HAVE always harbored a rather sympathetic interest in the three-tube, loosely coupled, tickler-feedback regenerative set for the excellent showing this smaller, less expensive contraption will make against five, six and eight tube sets. My choice still rests with the Old Reliable, brought up to date with some of the new units and accessories that the profession now boasts.

Briefly, let me enumerate some of the features of the set.

A space-wound coil, together with one of the new low loss condensers, makes it highly selective. This selectivity is further emphasized by the use of loose coupling of the antenna to secondary circuit, which likewise reduces the nuisance of malignant squeals, so often evident in broadcast reception.

The receiver has five controls in all on the panel. Only two of these are actively used, the secondary tuning circuit selecting the station and the tickler controlling the regeneration, which contributes to the distance-getting qualities of the set. The remaining three are but rough settings, the antenna coil angle being varied with the knob you see at the extreme left of the panel view (controlling the input and incidentally the selectivity and volume as well); the two fila-

ment controls, one for the detector and one for the two audio amplifiers.

The set employs two low ratio high grade stages of audio amplification, connected in the usual cascade fashion. A pencil mark grid leak is used; chiefly because its performance is thoroughly satisfactory but also because of its inexpensive nature.

Openwork construction, plenty of room for charged bodies and wire, carefully placed units together with an unusual style of wiring, makes this set, in my estimation, one of the most efficient that I have yet seen.

I can best illustrate the selectivity of such a set by referring to my own results. I am but one mile from WEBH (1290 k.c.) and less than that from WQJ (670 k.c.). Within a radius of 10 miles are WBBM (1330 K.C.), WIBO (1330 k.c.), WENR (1130 k.c.) and WDBY (1160 k.c.), WGN (810 k.c.), KYW (1500 k.c.), WLS (870 k.c.) WMAQ (670 k.c.), WGES (1200 kc.) and WMBB (1200 k.c.). They all seem to be going at once when I want to try for long distance. Right here I want to say that I'm no radio liar, and I don't claim to tune them all out and get anything I want. But I do break

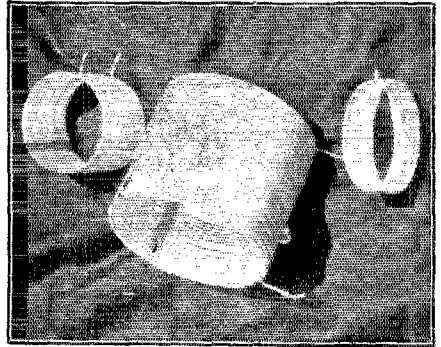

THE THREE COILS.

through with this set and with at least half of the above broadcasters going, I tune in KDKA (975 k.c.) WOC, (620 k.c.), WSAI (975 k.c.) all the suburban stations like WTAS (941 k.c.) WJJD (990 k.c.) and WORD (1090 k.c.) an listen to them with little or no interference. I can separate WLS (870 k.c.) from either WGN (810 k.c.) or WEBH (1290 k.c.) (one mile away) without the least interference from either.

This trick is accomplished by spreading the tuning of these stations out over the scale by means of a tapped coil. The coil is a 47-turn 4-inch, space-turn winding, with a tap at the thirtieth turn. When the clip (used to vary the number of turns) is on the forty-seventh turn the set tunes

* 9DQS and Technical Edition of *On The Air*, 1304 Kimball Hall, Chicago.

(with a .0005 μ f Cardwell) from 300 to 600 meters with plenty of separation on the high wave stations, and when attached to the thirteenth turn, WQJ at 448 meters (670 k.c.) can be received with a 100 division dial set at 95.

This spreads the tuning on the lower waves out considerably, and enables me to separate the Class A stations without especial difficulty. When the dial is set

- 2 Pieces of bakelite for coil mounting $5 \times \frac{1}{2} \times \frac{1}{4}$ inch.
- 2 Pieces of bakelite for L_1 and L_2 mounting (to rod). Size $2 \times \frac{1}{2} \times \frac{1}{4}$ inch.
- 2 Pieces of brass rod 6 inches long $\frac{1}{4}$ inch stock for shafts L_1 and L_2 .
- 4 Pieces flexible wire lead for L_1 and L_2 8 inches long.
- 1 Small clip tight jawed.

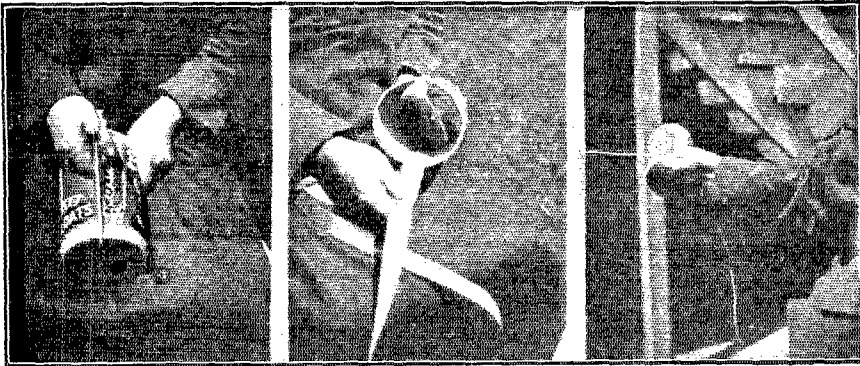

WINDING THE SECONDARY.

around 10 the 180-meter phones of the amateurs can be heard, and not infrequently have I enjoyed listening to them. With the clip set at the forty-seventh turn, the tuning of the low-wave stations becomes very critical, decidedly so under 350 meters. By setting the dial at 95 I often copy stations on lake steamboats handling radio telegraphic traffic.

How to Make the Set

But this recounting of results is nearly always boring. The description of the set's construction is immeasurably more interesting so let's hop to it.

Our first consideration lies in the selection of the proper parts and accessories. I am giving the trade names of them just as I used them.

List of Parts

- 1 Bakelite Formica or Radion panel 7" x 21" x $\frac{3}{16}$ ".
- 2 Dials 3-inch size.
- 1 National Velvet vernier dial 4-inch size.
- 2 Allen-Bradley carbon disk rheostats, universal type.
- 1 Carter 4-spring jack.
- 1 Carter 1-spring jack.
- 6 Round head brass screws, $\frac{3}{4}$ inch.
- 1 Yellow clear pine baseboard (dried and sparvarnished). Size $10 \times 21 \times \frac{1}{2}$ inch.
- 2 Theaded brass rods $3 \frac{1}{2}$ inches long $\frac{3}{16}$ in stock, and 4 nuts to fit.
- 2 Brass coil mounting brackets $1 \frac{1}{4}$ inches high with $\frac{1}{2}$ inch feet top and bottom.

- 2 Pieces brass $2 \times \frac{1}{2}$ inch $\frac{1}{32}$ stock. Shaft bearings.
- 1 Pyrex or porcelain socket.
- 2 Kellogg tube sockets (audio stages).
- 1 Cardwell 21-plate .0005 μ f condenser.
- 2 Karas Harmonik audio transformers.
- 1 Fleming binding post strip (has 7 posts).

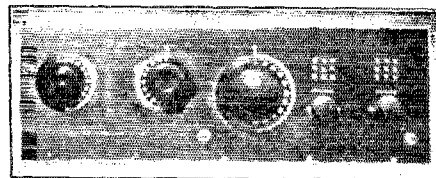
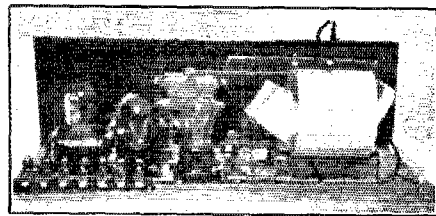

THE FINISHED RECEIVER

- 3 Dubilier or Muter .00025 μ f. condensers, fixed.
- 1 Dubilier or Muter .002 μ f. condenser, fixed.
- 3 UX201A or CX201A tubes.

- 1 Pencil Mark grid leak (round type with cap).
- 4 Lengths bus-bar wire.
- 5 Feet No. 18 rubber-covered wire.
- 2 Dozen assorted mounting screws.
- 1 A battery.
- 2 B batteries, Burgess or Eveready, 45-volt.
- 1 Antenna not over 85 feet total length.
- 1 Spool No. 18 D.C.C. wire $\frac{1}{2}$ pound.
- 1 Spool No. 22 D.C.C. wire, $\frac{1}{4}$ pound.

Most of the panel drilling is obvious from the drawing. The following points should, however, be watched.

The drilled hole for the shaft of the variable condenser is located on the drawing. The other mounting holes for this unit and the National vernier dial are determined from the template and the instructions enclosed with these pieces of apparatus. I drilled a series of 9 holes above each rheostat for ornamental purposes, in rows of three, the first row being $1\frac{1}{2}$ inches from the top of the panel. The

white substance. I used nail-white.

If you have made a neat job the panel need not be rubbed, but if you find it has been scratched in the course of drilling, rub it with a medium or fine sandpaper until all the shiny surfacing has been removed,

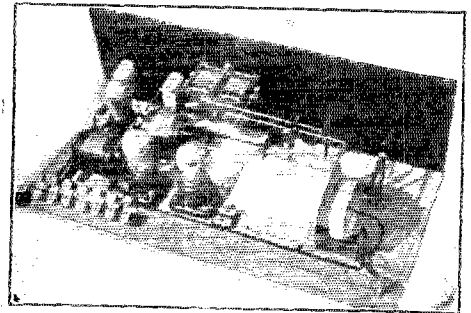
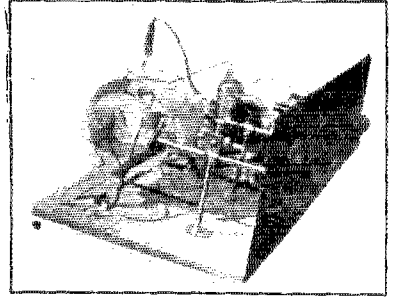

END AND TOP VIEWS OF THE FINISHED RECEIVER

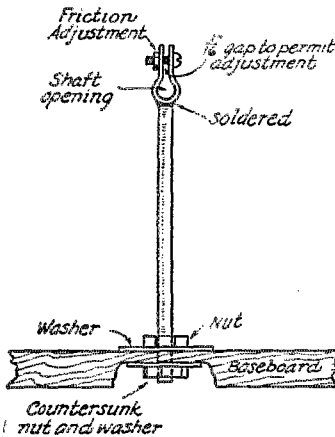

REAR SHAFT BEARINGS AND STANDARD

center row is exactly above the rheostat knob, and the holes are separated by a half inch.

Use your own judgment on the sizes of the drills, and follow the templates and instructions given with the condenser and dial. Only one hole apiece is necessary for the rheostat and jacks.

The shaft holes S_1 and S_2 should be drilled with a quarter-inch drill, and they should be made carefully, since the panel acts as a bearing for the shaft in turning. In drilling all of the large holes put a small drill ($1/8$ " or $1/16$ ") thru first to locate the hole. The small drill had best be started in a light locating mark made by means of a hammer and center punch.

Engrave indicators if you wish, and fill them with jewelers' wax, Bon-Ami or other

and then wipe it with a rag which has been saturated with thin oil.

The front bearings of the tickler and antenna coil shafts are the $1/4$ " drilled holes in the panel. The rear bearings are constructed as shown in the drawing. The bearing itself is made by folding one of the 2 " x $1/2$ " brass strips around one of the shafts and bending to a fit with a pair of

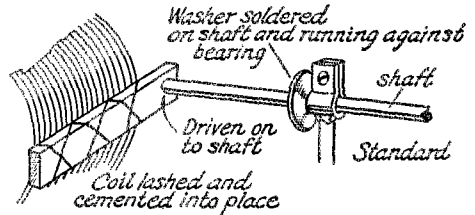

COIL MOUNTING ON SHAFT

pliers. This strip is then soldered to one of the threaded rods listed in the bill of materials and mounted on the baseboard.

The antenna coil standard is located 3" behind the panel and $2\frac{5}{8}$ " from the left

edge of the baseboard. The tickler coil standard is placed 5" to the right of that.

The $\frac{1}{2}$ " x $\frac{1}{2}$ " x $2\frac{1}{2}$ " pieces of bakelite are then driven onto the end of the shafts and secured with shellac or collodion if necessary. The coils are tied to these pieces with thread.

Winding the Coils

The coil winding is not difficult.

Procure two bottles of $2\frac{3}{4}$ inches outside diameter. Next cut three strips of celluloid (auto curtain stuff is O. K.), the strips being the length of the bottle and about $3/16$ inch wide. Fasten them to the bottle securely, dividing the circumference into three even sections. They may be held in place with gummed paper or tape.

The coils L^1 and L^2 are wound on forms

it and the preceding turn, the space being about the thickness of the wire. The turns are rolled on, the rolling being accomplished by unwinding sufficient wire for the coil before starting the rolling, and straightening by fastening it securely to some post or object, and pulling until all the kinks have been removed.

When 30 turns have been made, make a twisted loop, and tighten it down to the former. Then resume winding until a total of 47 turns have been rolled on. This number of turns is satisfactory if a Cardwell condenser is used. If you intend to use another type, better put on a few more turns, say about 55, and prune the coil down till a 535 meter station comes in at about 85 on the secondary dial, with the clip set at the 47th (end) turn.

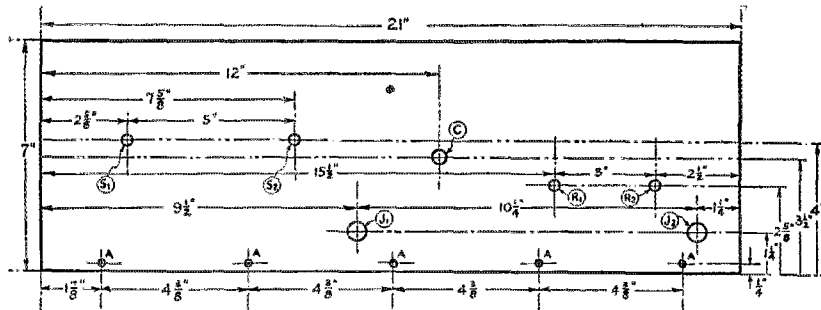

PANEL LAYOUT

- AAAAA—Holes for screws which secure panel to baseboard.
- J1—Detector jack. Drill to fit jack used.
- J2—Amplifier jack. Drill to fit jack used.
- S1—Shaft of antenna coil. Drill $\frac{3}{4}$ ".
- S2—Shaft of tickler. Drill $\frac{3}{4}$ ".
- R1—Detector rheostat.
- R2—Amplifier rheostat.
- C—Drill to size $\frac{3}{4}$ " larger than condenser shaft. Locate other condenser mounting holes as described in text.

like the one described; L^1 having 20 turns, and L^2 having 40 turns. The ends of the wire (beginning-end and finish of the coils) are held in place with tape or gummed paper, and collodion is painted over the wire exactly where the celluloid strips lie on the glass. When this has been done set them aside until thoroughly dry. Then break the bottles gently, and, lo! you have an air supported coil.

The secondary coil, L^2 , is wound in a slightly different manner. Procure a Quaker Oats box, and slit it into three longitudinal sections, one at a time. As each slit is made, back it up with gummed paper. (See the illustrations accompanying.) Then three strips of celluloid are laid over the cuts and fastened into place with gummed paper. Punch two holes in the cardboard former, thread the wire through and start winding. No. 18 D.C.C. wire is used on this coil. The turns of this coil, as well as those of L^1 and L^2 , are spaced, that is each turn is wound with a space between

After the required number of turns has been wound, fasten the finish end and paint collodion over the wire at the celluloid strips. Allow the collodion to dry thoroughly. Then with a knife, cut away the gummed paper strip backing the longitudinal cuts, and the form will come out easily. Do this carefully, so as not to spoil the cylindrical effect of the coil.

The clip, soldered to a piece of flexible wire, which is in turn soldered to a piece of bus bar connected to the A plus side of the filament and the rotary condenser plates, is held rigid on a piece of glass rod forced into a hole in the baseboard, and held firm with glue or collodion. The photographs of the set show this detail.

Mounting

Next mount the condenser and dial, the rheostats and jacks, and screw the panel to the baseboard.

Inspect the terminals and connections of

the sockets and transformers thoroughly, and bend the springs of the tube sockets up so that no poor connection can develop later.

Then proceed to screw these units into place on the baseboard as shown in the illustration. Mount the binding post strip

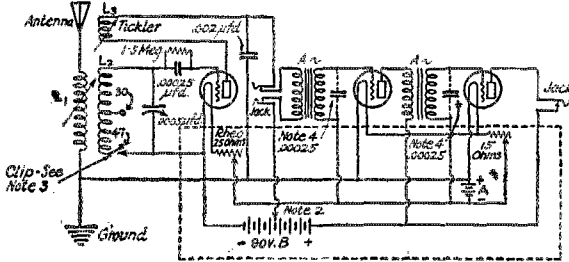

CIRCUIT DIAGRAM

L1—Antenna coil 20 turns 2 $\frac{3}{4}$ " dia. No. 22 wire. Wound spaced or solid layer.

Notes—1.—Wavelength range 190-450 using 30 turns, on up to 575 using 47 turns.

2.—Detector voltage variable 16-37.

3.—Turns variable by clip inside set, not by switch or panel.

4.—250 uufd (.0025 microfarad) shunt condensers used only if set insists on whistling.

on the back right hand end of the baseboard. The parts are located as follows: Directly back of the condenser is the detector tube and socket then the second audio tube, immediately under the end of the variable condenser the first A.F. transformer for stage number one, and directly back of the right hand rheostat is the first audio frequency tube. Back of this we have the second audio transformer. The apparatus has been so placed to minimize the wiring of the set.

Wiring

Start wiring the set by putting in the filament circuits, using the No. 18 rubber insulated wire. This wiring is all run along the baseboard, and is kept bunched and in a well defined path throughout the set. You can see what is meant from the illustrations. The wire running from the binding post strip along the two tube sockets, and by the coil is the A plus bus, also the ground wire, and shows how the insulation is chipped off and the joints soldered in T fashion to the main wires. The A plus, A minus, all the B battery leads and wires connecting to the ground are made with the rubber covered wire. The plate, grid and audio input and output leads alone are made with bus bar. Only 9 connections are made with this bus bar wiring.

Since all coils are wound in the same direction it will make little or no difference where the flexible leads of L¹ and L² are soldered. Reversing them sometimes gives better results.

After the filament circuit has been put in wire progressively the antenna circuit,

secondary input circuit, detector plate circuit, first amplifier and then the second amplifier. All the battery leads in rubber covered cable should be completed first, however.

The grid condenser and leak are soldered directly to the grid post of the detector tube socket having been soldered together before the wiring commences.

Operation

Operation is very simple. The batteries, antenna and ground are connected and the tubes inserted. Inspection of the wiring should take place before the B circuit is closed, however.

Increase the filament brilliancy until normal is reached, and start operating by setting the condenser at 50 degrees. Advance the tickler till the set oscillates. It may be necessary to reverse the connections to L3. If it still does not oscillate, adjust the grid leak until it breaks into regeneration with a soft hiss. Knocking indicates too high a resistance of the leak—more pencil marking should be added. If it sounds mushy, erase until the best effect is obtained.

The rest is very simple. Rotate the secondary dial, with the antenna coil set parallel to the secondary inductance, and when a signal is heard, increase the regeneration until the best reception is obtained.

Not infrequently, I find that the present day tubes, when used as audio amplifiers, give off a high pitched whine or whistle. To eliminate this I solder a .00025 ufd. fixed condenser across the G and F minus terminals of the transformers. This simple expedient eliminates the objectionable noises entirely.

Strays

NAO1 is another of the short wave Navy sets, located at the Charleston (S. C.) Navy yard. A 500 cycle supply and a remote control that sometimes is more remote than control.

The following stations are crystal-controlled and are in operation fairly regularly; 1BAY, 2WC, 4BK, 4BY and 4XE. Pse drop us a line, OM, when you convert yours to crystal control.

Some prospective ham writes in and tells us that he wants to join the A. R. R. L., I. A. R. U. and *NRRL*! Fix him up, Admiral Schnell.

A Power Amplifier for the Low-Powered Transmitter

By Rufus P. Turner*

A GREAT number of transmitting amateurs in this country have constructed low-powered C.W. transmitters, employing a single U.V. 199 or U.V. 201-A receiving tubes as the oscillators, for use this winter in competition for the Elgin "biscuit", offered by the Jewell Electrical Instrument Company as a prize for record low-power D.X. transmission. Most of these experimenters are using a

Fig. 1. L2 feeds energy into the antenna circuit while L3 is coupled to the output of the transmitter. The power delivered to the antenna is equal to that of the amplifying tubes (or less) regardless of the power of the transmitter which is coupled to L3. To those who have never come in contact with this system of transmission before, I might state, at this point, that the transmitting circuit, when it is coupled to a power amplifier in this manner, is referred to as the "master-oscillator", and its purpose is merely to excite the grids of the amplifiers. The tubes may be U.V. 199's or 201-A's, and as many may be used as the experimenter desires by connecting them in parallel (grid to grid, plate to plate, etc.). Two tubes are shown in the circuit, but one may be used if the enthusiast cannot afford the other one.²

L1 is a small antenna coil consisting of ten turns of No. 18 annunciator wire wound tightly on a two-inch diameter cardboard tube and coupled to L2 which consists of ten turns wound on a three-inch diameter tube. The coupling is not critical: simply place L1 inside of L2. L2 is tuned by a 250- μ fd. variable low-loss condenser, C2. The antenna circuit is tuned by a variable series condenser C1, whose maximum capacity may conveniently be 500 μ fd. MA is a 0 to 10 milliammeter connected in the plate cir-

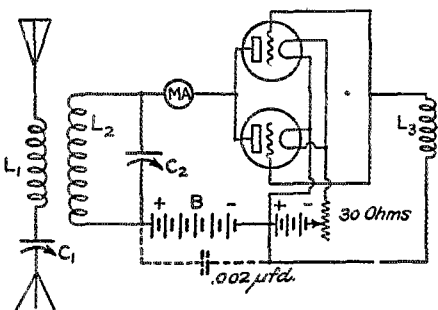

FIG. 1 THE R.F. AMPLIFIER

simple oscillator circuit such as the Hartley, coupled to the antenna and are getting out, much to their surprise.

However, the fellow on the other end frequently reports the signals unsteady, and the low power enthusiast will find that the swinging of his antenna has a greater harmful effect on his radiation than on the radiation of larger transmitters. He must then turn to some device which will steady his wave. The only panacea is the power-amplifier which is, primarily, nothing but a radio frequency amplifier connected between the set and the antenna.¹

It was found necessary to connect such a device with the low power set at 3LF, and after the necessary hitching up was done the wave was as steady as that of the larger set at the same station. The power amplifier was designed for use at a wavelength of forty meters, and it is recommended that other experimenters use the same wavelength.

The circuit of the amplifier is shown in

*3LF, 427 Franklin St., N. W., Washington, D. C.
 1. The crystal-control idea must not be overlooked. Properly operated such a control is said to give steadiness superior to that obtained from a master-oscillator with a power-amplifier. When the "M. O. P. A." system is used with the idea of obtaining a steady wave the M. O. should not be much smaller than the P. A. Some experimenters even insist that the M. O. should be larger than the P. A.—Tech. Ed.

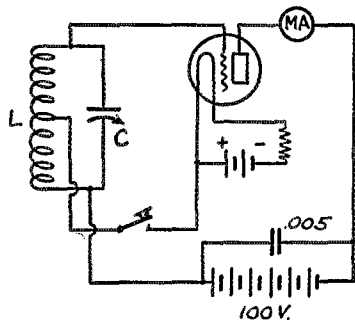

FIG. 2 THE MASTER OSCILLATOR OR DRIVER

cuit of the amplifiers. The "B" battery delivers a potential between one-hundred and one-hundred fifty volts, and the "A" battery either four and a half or six, depending on

2. Within reason, of course, at forty meters more than 4 UV-201A tubes would probably be unprofitable. With larger tubes or lower wavelengths even fewer should be used. The 199 tube (being less uniform) the M. O. should be larger than the P. A.—Tech. Ed.

the type tube employed. L3 is a small pick up coil consisting of ten turns of annunciator wire wound tightly on a two-inch tube, in the same direction as the inductance of the master oscillator.

A suggested master-oscillator is shown in Fig. 2. It is nothing more than a series-feed Hartley circuit which uses a U.V. 199 or 201-A as the oscillator, with a 100 volt "B" battery. The coil L consists of fifteen turns of annunciator wire wound on a 3-inch tube and tapped at the seventh turn and shunted by a 250- μ fd. variable low-loss condenser, C. M is a 0-10 millimeter which shows when the set is oscillating and facilitates tuning.

L3, of the power amplifier is placed inside of L of the master oscillator. The wavelength is adjusted by C. The condensers C1 and C2 need little attention and when once set may be forgotten.

The advantages of the master-oscillator power-amplifier transmitter are to be appreciated in low power work, and I am quite sure all the low-power experimenters will welcome, with open arms, the device described in this article.

Some Changes at Headquarters

WE regret to announce the separation from our staff, in middle February, of Edwin Adams, who for the past six years has served as QST's advertising manager. Mr. Adams was the oldest headquarters man, in point of service, next to the Secretary-Editor, having joined us in 1919 when Headquarters consisted of three people, two dark little rooms, one battered desk, one ditto table and one very ditto typewriter. He has seen us grow, and his own efforts have been responsible for a large part of that growth. He now becomes advertising manager of "The Financial Digest," a monthly magazine devoted to the financial interests of New England and the east, with offices in New York and Hartford, to which work he carries the best wishes of the Hq. Gang, all of whom much regret his departure.

F. Cheyney Beekley, our managing editor, becomes our new advertising manager, succeeding Mr. Adams. Mr. Beekley will also continue as managing editor, in which department of his work he will be assisted by Harold S. Johnson, 1HN, of Hartford, a new addition to our staff.

Louis W. Hatry, ex-5XV of Port Arthur, Texas, formerly department editor of QST and for the last ten months in charge of our Information Service, left our staff on February 1st, being succeeded by Harold P. Westman of New York City. Mr. Westman for some time has been in charge of radio experimental work at the W. R. Seigle Laboratories at Mamaroneck, N. Y., station

2BQH. In addition to the Information Service he will become the manager of our Experimenters' Section, as announced in greater detail in the report of that section elsewhere in this issue.

We are unhappy to have to report the abandonment in middle February of our A.R.R.L. News Bureau, and with it the disbanding of the field force of Inkslingers, a step made necessary by the necessity for headquarters economy. By this move we lose the services of Wm. C. Murray, for the past ten months the manager of the Bureau. His able assistant, Miss Nourse, remains with us, being transferred to new duties. Publicity work will not be abandoned, the regular bulletin service to newspapers being continued. We wish at this time to acknowledge with deep gratitude the splendid services of the 350 loyal members who constituted the field personnel of the Bureau. They did splendid work, and in particular in the handling of our very difficult relations with the public during the trying days of adjustment between brass-pounder and BCL they rendered a service to A.R.R.L. which no member should ever forget.

It will be apparent from the above paragraphs that we occasionally have shifts and openings at Headquarters. We desire, whenever we can, to fill these vacancies with qualified League members. We have room here for talent of many sorts. We therefore invite members interested in Headquarters positions to file their names with us, with complete particulars as to their qualifications, in order that they may be given consideration when vacancies occur.

—K. B. W.

Strays

Everest of 1ARE is responsible for a very simple and novel "center tap" stunt. On filament transformers having no center tap, he connects two Christmas tree lamps, in series, across the secondary and makes grid and plate returns to the mid-point between the lamps. It works F. B., too. If one side of the circuit has more capacity than the other, one lamp burns brighter than the other. By shifting the wires the lamps will burn with equal brilliancy.

W. W. Knight of the Philadelphia Navy Yard has been playing with extreme short wave reflector stuff. He lives at a place where a lot of sand trucks go by each day and shake the house a lot. When the plaster started to fall off the walls his landlady put him out because she saw that these new fangled vibrations of his were gradually wrecking the place.

6XBR, 108 Meters

By Hal Shaw*

6XBR is the Portable Broadcast station of Warner Brothers West Coast Studios. The difference between this and other stations similar to it, is that it is, like our good old QST, for, by and of the Amateurs. Not only is it a Broadcast station on wheels, but is at the disposal of the Amateurs at any time and anywhere, but we'll get at that a little later.

One photograph shows a broadside of the input panel and transmitter. At the right

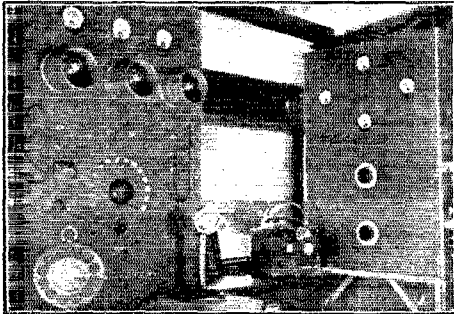

TRANSMITTER AND INPUT PANELS

of the picture is the transmitter which uses 250 watts in the coupled Hartley circuit. This circuit was picked because of its flexibility and ease of operation. Other circuits were known to be more stable, but there was no apparent reason why the Hartley could not be made to function properly. And take it from us, it DOES. Eight inches of coupling is used. The normal antenna current is three amps. The secondary is detuned until the antenna current has dropped one-half and the wave is as steady as one could wish for. Referring to the photo again, the right hand panel is the transmitter. The top meter is a 0 to 5 Weston thermoammeter (all meters are Weston), center left, oscillator mils; right, modulator mils; and the lower one for the grid mils of the oscillator tube. The two dials shown, have double spaced condensers behind them, one being in the closed circuit and the other in series with the antenna. One of the loading coils may be seen over the transmitter, it being necessary to use two in order to get the open circuit up to the proper wavelength.

Next in line is a General Radio wave meter with a range of from seventy-five to well over six hundred meters. Each time the truck is moved, the set is completely retuned. The Heising system of modulation

is used with the usual amount of success. A fifty-watt speech amplifier is employed in the modulation circuit. The panel on the left of the photograph is the input system. Three stages of impedance-coupled amplification are used. Thordarson transformers are used. W.E. input and output transformers are used. From top to bottom on the panel, the controls are as follows: The three meters are used to test for proper microphone current, filament and space current on each tube at will. Next in line are the three 205D Western Electric amplifying tubes. They are separately shielded. The three jacks on the left are for testing the space current, the two center ones for the microphone, while the right hand ones are for filament current. The gain control can be seen in the center, while directly under it is the light to show when the microphone is in use. The switch under the light is for throwing from one "Mike" to the other. The three G.R. rheostats shown are in the filament circuit of each tube, that is, one for each tube, while the microphone potentiometer is hidden behind the "Mike." The row of switches at the bottom of the panel are for turning on or off the current used on the input panel. The close-speaking "Mike" on the right of the picture is used when making announcements from the truck, as the generators did make three

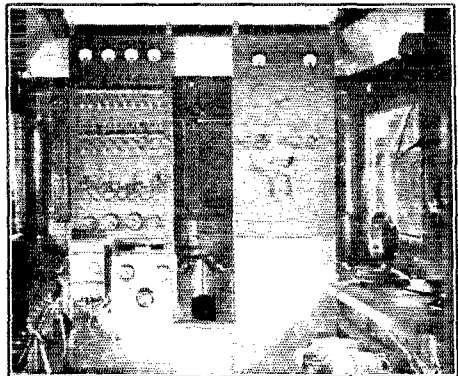

CONTROL AND CHARGING PANELS

times too much noise for their size. This, however, has been remedied. Both the input and transmitter panel are shielded on all sides, as can be seen in the photograph.

Another photo shows the layout of the control and charging panels as well as the batteries and generators. Reading from left to right the bank of "B" batts totalling 150

* Warner Brothers Pictures, Inc., 5842 Sunset Blvd., Hollywood, Calif.

volts are for the input panel. The left hand panel controls the charging and discharging of all batts. Mounted on the lower portion of this panel are the two chargers; the smaller one for the "B" batts, and the other for the filaments of both the input and transmitter panels. Directly behind this panel may be seen one 32-volt bank of batteries. There are two banks of these, one for each generator. The four meters at the top of this panel are for "B" battery "A" batteries (both 6- and 15-volt) and the motor-generator batteries. The right hand panel controls the motor-generators. By an arrangement of switches either or both of the generators can be put into service at will. Two 0 to 2000 voltmeters give the reading of each generator separately, so that at all times the voltage of each generator is known when they are run in parallel. Behind this panel are the second bank of 32-volt batteries and to the right of these are the filament batteries. The generators run at 6000 R.P.M. and deliver 230 mills each at 1500 volts. The snells of the generators have been cut to allow ventilation. All wires in the truck are run in lead conduit in order to get away from radio frequency pick ups. The panel brackets and everything else that can be grounded is connected to the body of the truck and that in turn is connected to as good a ground

this page, shows a full view of the works from the outside. The antenna, as can be plainly seen, is an almost vertical flat top. It measures in length about 30 feet. The counterpoise runs around the top of the truck and is supported about every three feet and insulated with porcelain. The rear tower is 30 feet high. The upper portion slides down into the lower and that in turn lies flat on the top of the bus. The front stick is fifteen feet high and folds down on the top also. The aerial is wound up and securely fastened on top with the two towers. The entire installation can be put into operation in less than fifteen minutes by one man. As the sign shows, a Moreland Motor Coach is the transportation. Jelly batteries are used throughout.

Very few stations have as their head a man such as Frank Murphy, the Electrical Engineer of Warner Brothers. He is completely sold on the merits of the Amateur and the A.R.R.L. For this reason he has made it possible for 6XBR to come into existence not only as a portable broadcast station, but one that the Amateurs may call on at any time for tests of any description. At an early date the truck may be sent on a nation-wide tour in the hopes that some of the tricks in short wave broadcasting may be brought to light. The entire works were constructed on the Warner Brothers' lot by Hal Shaw and Ben McGlashan and the boys in the electric shop under the supervision of Mr. Murphy.

It was at this time that Traffic Manager Schnell showed up and we of the operating staff of KFVB want to take this opportunity to apologize to him for not giving him any more attention than we did. It wasn't much. Next time we will do better.

In addition to the foregoing, Mr. Murphy has promised in the very near future the construction of a lab for the research into the mysteries of Radio as a whole. The first step we want to take is to ally ourselves with the Experimenters Section of QST.

A watch on all amateur bands will be kept at regular hours and it is hoped that schedules can be made with every one. We want to go in strong for crystal controlled transmitters.

The truck has been on the air for approximately two weeks and has been picked up in Illinois, Indiana and Alaska. We would appreciate reports from amateurs and each and every one will be QSL'd.

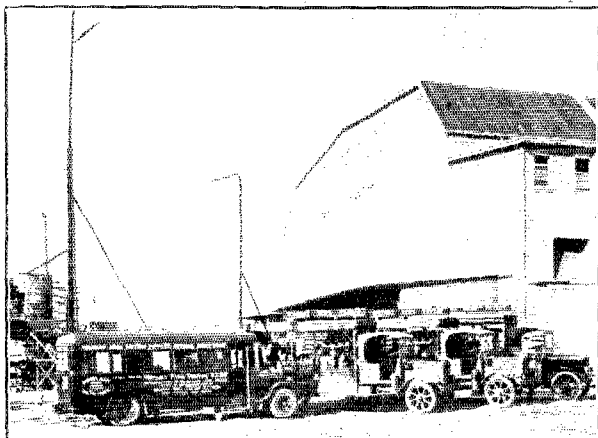

THE MOTOR COACH CONTAINING 6XBR
Note front and rear masts.

as can be had at the time the set is put in operation. As a result the operator or any number of people can go in or out of the bus and the wave remains constant, in fact, every experiment was tried to throw the wave off when under operation, but the set went merrily on with no swinging at the receiving end nor any change in antenna current at the transmitter.

The larger photograph, appearing on

Amateur Radio to the North Pole Again

By F. H. Schnell, Traffic Manager

Another expedition goes to the North Pole. Amateur radio is to be the sole means of communication. Two well-known amateurs, Howard F. Mason and Robert Waskey, of the Northwestern Division, go as operators. Amateurs all over the world are asked to keep watch for KFZH and KFZG on 24 m. (12,500 Ks.) 35.5 m. (8,450 Ks.) and 73 m. (4100 Ks.) First tests probably will start in early March.

WHEN Captain Donald B. MacMillan said that he believed no Polar Expedition would ever attempt to go north without radio equipment, he made a prediction that is already being realized. Because of our previous successes in this unusual work, the A.R.R.L. and amateur radio has been called upon to furnish communication for the Detroit Arctic Expedition and the North American Newspaper Alliance.

Just about the time you are reading this story, radio tests will be started from the base station at Point Barrow, Alaska, where Howard F. Mason (7BU), former Division Manager of the Northwestern Division and former Department Editor of QST, will operate the main control station. His assistant will be none other than Robert "Bob" Waskey, (7UU) also of the Northwestern Division. Two better amateurs for this work—well, anybody who knows them realizes they can be depended upon to

is from this base that all stories and communications for N.A.N.A. will be started—the destination being NORTH AMERICAN NEWSPAPER ALLIANCE, 63 PARK

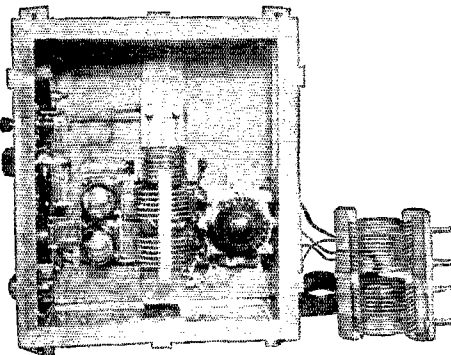

COMPLETE RADIO TRANSMITTER, LESS BATTERIES, IN THE ALUMINUM CASE.

Key fastened to small board so it can be strapped to operator's knee.

ROW, NEW YORK CITY. Please make note of that and remember all news or other communications for N.A.N.A. are to be

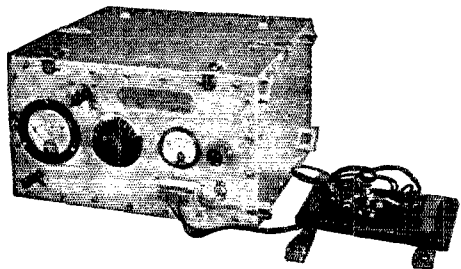

TOP VIEW OF TRANSMITTER WITH LID REMOVED. CONDENSER AND DIAL AT REAR CONTROL TRANSMITTING WAVE LENGTH.

do the trick if anybody can do it. Mason will have entire charge of the radio work and he will use the calls KFZH and KFZG and probably his own amateur call on 24 m. (12,500 Ks.), 35.5 m. (8,450 Ks.), and 73 m. (4100 Ks.), selecting the wave length best suited for the particular time of the day.

The base station at Point Barrow, Alaska, will be the old NRRL set—complete except for the plate supply which may be d. c. instead of 250 cycles. If the old junk gets out as fast for Mason and it did for me on NRRL, there will be no worry about good QSO. Say, gang, NRRL did get out, didn't she—if I do say so myself! I hope Mason has even better reports to bring back. It

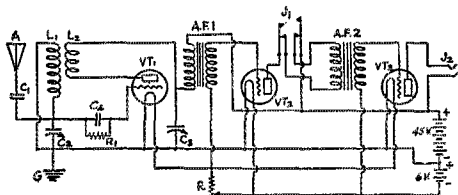

CIRCUIT DIAGRAM OF THE RECEIVER

- C1 Antenna coupling condenser. Two 3/4" copper discs spaced 3/8".
- C2 Karas 5 plate condenser SFL max. capacity .0008972 mfd.—secondary tuning.
- C3 National 11 plate condenser—regeneration control.
- C4 Grid condenser of fixed mica. .000125 mfd.
- R1 Daven 7 meg. grid leak.
- R General Radio 10 ohm rheostat.
- J1-J2 Frost jacks.
- VT1-2-3 Cunningham C302A tubes.
- AF1-2 Thordarson 3 1/2 to 1 a. f. transformers.
- L1 for 80 m. 24 turns L2 5 turns.
- L1 for 40 m. 10 turns L2 3 turns.
- L1 for 20 m. 4 turns L2 2 turns.
- L1 No. 16 enamel wire 3" diam. spaced 1/4" supported by paraffined maple strips.
- L2 No. 22 enamel wire 2 1/4" diam. wound on short bakelite tube.

given to no other organizations or individual. It is these press despatches that we amateurs are going to handle in the same manner we did for Captain MacMillan when Don Mix first went north with amateur radio. Plans have been made for 9EK-9XH (C. F. Burgess Laboratories, Madison, Wis.) to maintain continuous watch 24 hours of the day during the expedition. Probably other stations will be added to the list where reliable continuous watches can be maintained, but with the "sleepless wonder" Don Mix, W. H. Hoffman and Phil Zurain at 9EK-9XH, it is going to take a good crowd of hams to compete with them. This does not mean there will be no communication with other hams. 9EK-9XH merely volunteered continuous watches—anybody else available? So much for the base station and operation.

This arctic expedition differs from any other that has started from the U.S. in that no ships will be used. The entire ex-

tain Wilkins proposes to continue his flight across the pole and attempt to reach Spitzbergen without landing.

The plane will be equipped with a portable transmitter and receiver, for use when on the ice. No communication, excepting possible broadcasts, can be made while the plane is in flight because of ignition QRM.

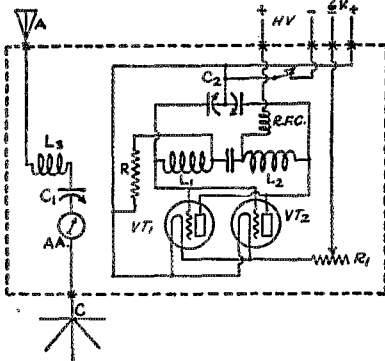

CIRCUIT DIAGRAM OF THE TRANSMITTER

- AA Jewell 0-.5 amp. r. f. meter.
- C1 Hartmann .00025 mfd. condenser—antenna series.
- L3 Antenna coupling coil, 6 turns No. 8 bare copper 1 3/4" diam.
- VT1-2 Cunnigham C301A tubes.
- R1 General Radio 10 ohm rheostat.
- R Grid leak—Ward-Leonard 5000 ohm resistance.
- R.F.C. Choke, 51 turns No. 22 S. C. E. wire, basket wound 1 3/4" diam.
- C2 Cardwell double unit, .00012 mfd.
- L1-L2 For 80 m. band 24 turns No. 14 bare copper spaced 3/16".
- L1-L2 For 40 m. band 12 turns No. 8 bare copper spaced 1/4".

ploration will be from a plane, which will "hop" off from Point Barrow some time between March 20th and April 15th. Captain George H. Wilkins, commander of the Detroit Arctic Expedition, with Lieut. Carl E. Eielson as pilot of the Fokker monoplane, will attempt to reach and explore the "Pole of Relative Inaccessibility"—the center of the polar ice pack. In event of failure to find suitable landing space on the ice, Cap-

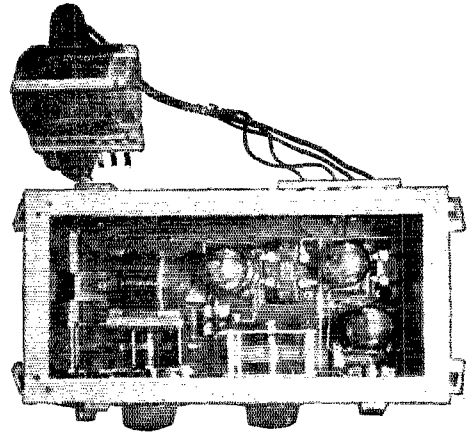

TOP VIEW OF RECEIVER WITH LID REMOVED.

Relative position of the apparatus can be seen. Brackets on four corners (transmitter also equipped the same way) permits mounting in any position.

The portable outfit can be set up on the ice in a very short time and will afford a means of communication with the base station. The transmitter is designed to cover all amateur bands with a large margin of safety on either side. The receiver also is

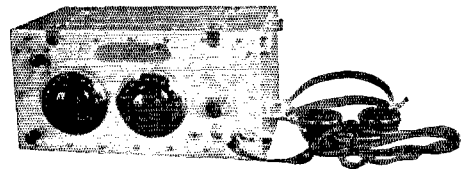

FRONT VIEW OF COMPLETE RECEIVER IN ALUMINUM CASE.

equipped for a wide range of wave lengths. Both of these pieces of apparatus were constructed at the C. F. Burgess Laboratories and will be loaned for the duration of the expedition. As in all other cases where great care is necessary, Burgess did an excellent piece of work in a limited time. So much does this apparatus appeal to the ham who wants a low power outfit and so complete in every detail is the description that we believe it will be of as much interest to you as it was to us at A.R.R.L. Headquar-

ters. There are plenty of excellent pictures and if you have been "stumped" on how to go about building a low-power transmitter, follow this description. Here is something for the broadcast listener who is standing outside the door of real amateur radio and looking through the window. Here is a portable outfit—the whole thing including mast and guys weighs only 45-½ pounds, less batteries.

**Portable Transmitter and Receiver*
ANTENNA POLE**

Five sections of bamboo pole 5 to 6 feet long and averaging about 2 inches in diameter are fitted with brass sleeve connecting joints. Total length, 30 feet. Bottom section fitted with steel point which holds base from slipping from position. Three rings at base of top section are fitted with guy



W. H. HOFFMAN (left) AND PHIL ZURIAN (right). Hoffman designed and supervised construction of the apparatus. Zurian is one of the regular operators of 9EK-9XH.

wires. Three iron pins for guy stakes are driven into the ice or earth for anchorage. Two men can erect mast in 10 minutes. Total weight, 17 pounds.

ANTENNA SYSTEMS

Two antenna and counterpoise systems of single rubber-covered flexible stranded wire are provided, one for transmission of the 40 M. (7,500 Ks.) band and another for the 80 m. (4,000 Ks.) band. Antenna consists of a single wire one-quarter of a wavelength long and the counterpoise consists of three wires—three-sixteenths of a wavelength long—laid out fan-shape under the antenna.

*Entire apparatus built at C. F. Burgess Laboratories, Madison, Wis., under supervision of W. H. Hoffman and W. B. Schulte.

TRANSMITTER

Two C-301-A tubes in parallel are used in a series Colpitts hook-up. A double unit tuning condenser mounted inside the case gives a range of 24 m. to 78 m. (12,500 to 3,850 Ks.) using two inductances, one for the lower band and the other for the upper band. Power supply (300-400 volts "B"

Mr. BROADCAST LISTENER:

Have you been looking in through the window at amateur radio and have you had the "itch" to construct and operate a low-power transmitter which will give you a range of 500 miles or more under favorable conditions? Have you the desire to make one of these "wireless sets" providing it isn't going to cost but a few dollars? Have you wanted to get into this game of telegraphy? Listen—if you have, first get as much sleep as you can, now, enough to last you the rest of your life—you won't get but a few winks a night after you get into this fascinating game. Then get busy and make yourself a set something like this. When you get stuck, don't quit in disgust. Instead, write to us at American Radio Relay League Headquarters, 1711 Park St., Hartford, Conn., and we'll be more than glad to help you. We may even be able to send some nearby amateur right over to your house.—F. H. S.

batteries) is fed through flexible leads. The key is fastened to a small board which can be strapped to the operator's knee when the set is out in the open (See illustration and list of parts.)

RECEIVER

Range, 13 to 108 m. (2775 to 23,000 Ks.) Sockets equipped to take either C-299 or C-301-A tubes. Tickler coils are fixed and

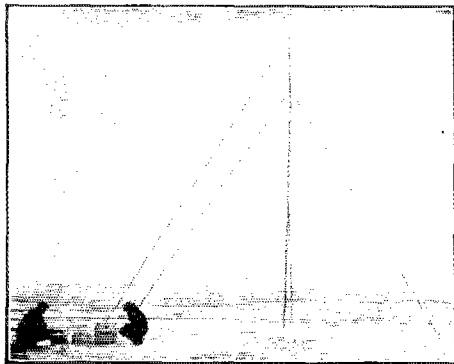

SHOWING MAST AND COMPLETE APPARATUS SET UP FOR OPERATION ON LAKE MONONA AT MADISON, WISCONSIN.

regeneration control is by means of a condenser. (See illustration and list of parts.) Transmitter and receiver are mounted in cases of aluminum .051" in thickness. Cases are secured to aluminum angle pieces in each corner. Tops of the cases are held in

position by special hook hinges which allow the top panels to be removed entirely or hinged to either the front or back edges of the case. Transmitter weighs 17 pounds and the receiver 11½ pounds.

RESULTS OF TESTS

The complete equipment was set up on Lake Monona and tested under conditions as nearly as possible approaching those under which the apparatus would be used up north by Captain Wilkins. It was then put into operation on the ground floor of the Burgess radio laboratory and here is a copy of the log:

Date	Time (C.S.T.)	Station Worked	Location of Sta.	Reported Strength
1/26/26	12:01 am	6MS	Los Angeles, Calif.	R 4
1/26/26	12:27 am	7WU	Portland, Ore.	R 6
1/26/26	1:40 am	2AES	New York City	R 9
1/26/26	2:05 am	1BKQ	Worcester, Mass.	R 6
1/26/26	3:21 am	2JN	Up, Montclair, N.J.	R 5
1/26/26	4:35 am	2NZ	Red Bank, N. J.	R 3
1/26/26	5:05 am	2KG	Astoria, N. Y.	R 5
1/26/26	5:35 am	1NX	Boston, Mass.	R 7
1/29/26	11:59 pm	9DU	Chicago, Ill.	R 3
1/30/26	12:24 am	9AJR	Chicago, Ill.	R 5
1/30/26	1:26 am	9EM	Seward, Nebr.	R 5

†Tests conducted on 40 m. (7,500 Ks.) ††Tests conducted on 80 M. (4,000 Ks.)

Neutralizing the Crystal Amplifier

A GREAT many queries have been received concerning the way to neutralize the power amplifier in a crystal controlled set, and how to tell when the neutralizing adjustment has been properly done.

In the first place if the power amplifier is operating on a harmonic of the crystal oscillator neutralization is not necessary. It is only necessary to neutralize the amplifier when it is being operated on the same wavelength that the crystal oscillates on. In order to do a thorough job of neutralizing, and in order to do the job quickly, it is most desirable to have the crystal oscillator in a shielded box and the power amplifier in another shielded compartment. The adjustment can be done quite readily then. The fields of the various coils in each circuit stay within their own cages and all sorts of crazy feedbacks are avoided.

Neutralizing can be done in several ways, the easiest is probably that shown in the drawing wherein L and L1 are the primary and secondary coils associated with the power amplifier. The amplifier is tuned to the crystal oscillator's wavelength by virtue of coil L and condenser C. In series with this condenser it is customary to have a thermo couple ammeter to facilitate tuning the power amplifier. The neutralizing scheme consists of the variable condenser C1 and that portion of coil L between points A and B. By varying both the condenser capacity and the turns in the A-B section neutralization can be secured and the power

amplifier can then be tuned exactly to the crystal oscillator wavelength.

In order to tell when the correct condenser capacity has been found it is easiest to proceed as follows: Replace the thermo ammeter A with an R.F. meter having a maximum scale of 25 or 50 milliamperes. A hot wire meter will do. Then cut off the plate voltage of the power amplifier tube but keep the filament lit. In all probability the milliammeter will show some deflection, indicating that it is picking up current from the crystal oscillator. Vary the condenser C1 and the turns in the A-B portion of coil L until there is no deflection on the milliammeter at A. It is safe to assume that the power amplifier is then properly neutralized.

Another method, requiring no additional apparatus, consists in varying the neutraliz-

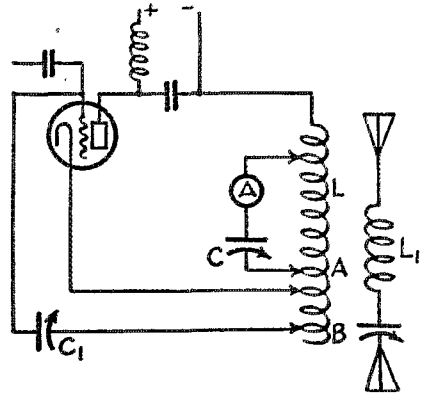

ing condenser (with no plate voltage on the power amplifier tube) until some point is found at which a variation in the capacity C will have no effect upon either the plate current in the crystal oscillator tube, or upon the R.F. in the L-C circuit in the crystal oscillator.

Mr. A. Crossley of the U. S. Naval Research Laboratory suggests that an electrostatic voltmeter connected across the power amplifier output will show no reading when the amplifier is neutralized and there is no plate voltage on the amplifier tube. Unfortunately we haven't the electrostatic voltmeter, tho.

—J. M. C.

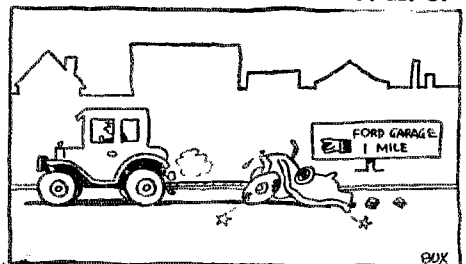

1 1/2 HENRY

“Pse QSL Card”

IT'S time something was done about the business of QSL cards, and this article is going to present a policy which it is suggested be adopted.

First, there has been a great deal of dissatisfaction from both foreign and American amateurs over the fact that most of the QSL cards sent out do not get a reply. The writer, as the member of A.R.R.L. headquarters staff who handles all QSL cards which are sent to the League for forwarding, has been observing both the cards and the remarks for some time, and the kick is coming just equally from American and foreign hams. It is true that many American amateurs do not reply to foreign cards; it is equally true that a great many foreigners do not reply to American cards; and it is a fact that most American hams do not reply to American cards.

Let us for a moment consider the case of the fellow who sends QSL cards. He takes a great deal of his time listening for signals, making notes on them, and later typing or writing out the cards. He also has gone to the expense of having cards printed up, and of buying stamps to send them. Therefore, when, as a result of several weeks' listening, and another week of writing, he sends out 150 cards, and gets replies to but 25 or 30 of them, he believes he is justified in registering a large and healthy hick. But wait a minute—is he entirely justified? It seems to us that the fellow who sent the cards should feel that he did it to help the other fellow, and that he shouldn't care whether they are acknowledged or not.

There is another side to the case. What about the attitude of the fellow who did the transmitting and who receives the cards? We will not treat here of the small group of hams—of all countries—who never reply to *any* cards. The writer is convinced that there are very few representatives of this class. We are talking now of the average transmitting ham, who replies to some, but not all, of the cards he receives. What is his attitude to the flood of cards that frequently come in? His attitude is about this: “Why should I be under obligation to go to the expense of answering several hundred cards from fellows with whom I have not communicated, and from whom I have not solicited reports? I have a big station, and I get a great many cards every month. Of course, I much appreciate the kindness of the fellows who go to the trouble of sending me cards, but I can't afford to answer them all. I would like to; but I can't take the time and money. However, I always reply to a card from a fellow with whom I have been QSO.”

There is some justification on both sides,

but more, it seems to us, on the side of the recipient of the cards. The fellow who sends out a lot of cards to stations he has heard (not worked) deserves commendation; but on the other hand, the fellow who receives several hundred cards, many of them from only several hundred miles away, is not too greatly to blame if he does not answer them.

With all this in mind, the writer has drafted the following suggestions for (1) the non-transmitting unlicensed listener who sends cards to stations that he hears; (2) the licensed active transmitter who sends cards; (3) the fellow who receives cards.

The Non-transmitting Unlicensed Card Sender

1. Send cards to foreign amateurs heard.
2. Do not expect an answer to cards sent to commercial short-wave stations such as FW, ANA, AGA, WIR, WGH WIZ, WQO. Most such stations, unless they especially request them, have no use for amateur reports.
3. If you live in the United States or Canada, do not send cards to any United States or Canadian amateurs unless you are perfectly willing to go without an answer.
4. Be sure to use an up-to-date call book.

The Licensed Active Transmitter Who Sends Cards

1. *When requested*, send a card to all stations worked, whether foreign or domestic.
2. Do not, if you live in the United States or Canada, send a card to any U. S. or Canadian amateur heard but not worked, unless you are willing to take a chance on getting no reply.
3. Send a card to foreigners whether heard or worked (optional).
4. Use an up-to-date call book.

The Fellow Who Receives The Cards

1. Always answer all cards from station with whom you have been QSO.
2. Always answer all foreign cards, regardless of whether you have or have not been QSO.
3. Do not, if a U. S. or Canadian amateur answer cards from unworked U. S. or Canadian stations who may wish to report your signals, unless you have plenty of time and really want to.
4. Use an up-to-date call book.

These suggestions are made in order that a systematized policy of card-sending may result in greater happiness for all concerned. We do not feel, in general, that there is any obligation to answer cards other than as specified above. But as a part-

ing thought we would like to leave the idea that *amateur etiquette requires that everybody send as many cards as they receive*. Send them to whomever you want, but you owe as many cards to the fraternity as you have received. The expectation of a direct QSL to all cards sent is something that ought to be firmly discouraged. We've seen some shacks papered with cards that were almost all acknowledgments of cards, not signals. That doesn't mean a thing—anybody can get that kind of wallpaper.

—A. L. B.

Tube Reactivation

A new piece of apparatus has been designed to simplify the problem of tube reactivation. It is the so-called "socket" reactivator made by the International Resistance Company, Inc., of Philadelphia. The device works on the flash and aging principle. A small button on the side of the socket enables one to flash the tube with a comparatively high voltage for a short length of time, and then let the tube remain in the socket during the aging process. The reactivator screws into any standard base lamp socket and works on both A.C. and D.C., a resistance being cut in when the button on the side of the socket is pressed. This gives the "flashing voltage" which should be left on for about forty - five seconds. When the button is released some additional resistance is added and the tube is allowed to age for about ten minutes after which it can be removed from the socket and should be entirely cured. The reactivator is made in two models, one for 199 type tubes and the other for the 201-A type.

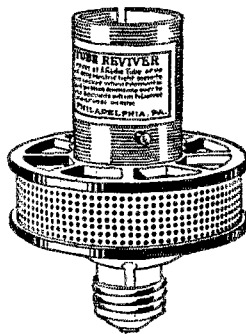

Strays

NAR1 is the 78 meter transmitter of Gunner G. W. Almour, located at the U. S. Naval Station, Key West Florida. The transmitter uses a single 204-A with a sink rectifier and is pumping a wicked signal all over the country. Almour was formerly at NERK1.

Attention Brass-Pounders!

The W. A. C. Club is being formed. It is to be an International affair, of interest to all Knights of the Nickeled Key. See QST next month,

Second District Convention

THE sixth annual Second District Convention will be held this year during the week of March 8th to 13th, again at the Hotel Pennsylvania, New York City. It is being run by the Executive Radio Council of the Second District, of which Capt. George T. Droste, 2IN, is president.

The affair is promised to be a real ham event, with all kinds of special stunts. The sixteen local clubs comprising the Council will have booths of their own on the balcony surrounding the grand ballroom of the hotel, wherein a show of commercial apparatus will be held. These exhibits are always interesting, because the enthusiastic members of the clubs spend whole months preparing them.

One of the smaller dining rooms of the Pennsylvania has been hired in addition to the ballroom space, and will be used as a lecture hall afternoons and evenings. Boyd Phelps, formerly of the QST staff, is in charge of this work, booking technical talks and demonstrations.

Of course there will be a grand banquet, with incidental entertainment that Ed Fink, 2GL, says will be eye-opening. Tickets for the feed, also covering admission for the entire week, are five dollars apiece, and can be obtained from the Council at its headquarters at 74 Cortlandt Street, New York City. The attendance this year will be strictly limited to about 400, and Fink promises there will be none of the crowding that marked the banquets of previous years. Johnny Reinartz is definitely booked as one of the speakers, and there will be many others also worth coming a long way to hear and see.

The Department of Commerce, through Mr. Arthur Batcheller, Second District Supervisor of Radio, will hold open house for hams seeking licenses. Examinations will be held every day. The Custom House men will also conduct the jamming and commercial and amateur speed contests, for which some valuable prizes are being offered.

There will also be two contests for receiving sets, of both the short-wave ham and BCL variety, and three for low, medium and high power ham transmitters.

Several private little stunts, admission to which will be gained through special tickets available only to hams, will be staged in one of small eating houses in the theatrical district. An "Erco" initiation and a "Night of Mystery" are being concocted.

The heads of the various committees are as follows: George T. Droste, 2IN, general manager; Frank Frimmerman, 2FZ, show manager; Paul C. Oscanyan, advertising; Robert Hertzberg, ex-2ABK, publicity; Earl Peacox, 2ADH, convention; Edward Fink, 2GL, banquet; Robert T. Morris, 2BQS, finance.

Finding the Inductance of the Filter Choke

By Edward W. Berry*

EVEN as "truth is sometimes stranger than fiction" so are facts often more accurate than rumor. The fellow you bought your filter choke coil from told you that it was a ten-Henry choke. He is just as positive of this fact as was the fellow of whom he bought it. You are, however, very apt, even while assuring your friends that it is a ten-Henry choke, to wonder how much of a choke it really is. The determination of the inductance of a large choke coil is not at all difficult. The collection of the necessary data is far simpler than the operation of the average transmitter. The mathematical part is perhaps a little more involved, but

termine resistance and formula (B) to determine impedance. Substituting these two values in formula (C) and solving for L will give the value of the inductance in Henries.

Let us follow these steps through. Connect a storage battery of about 6 volts across the choke to be measured. Note the current flow with a milliammeter. The one used to measure plate current will do very nicely. If the current is too great for its range reduce the voltage by cutting out one or two cells of the battery. When a reading well within the range of the meter has been obtained, measure the voltage across the coil. In our example the voltage

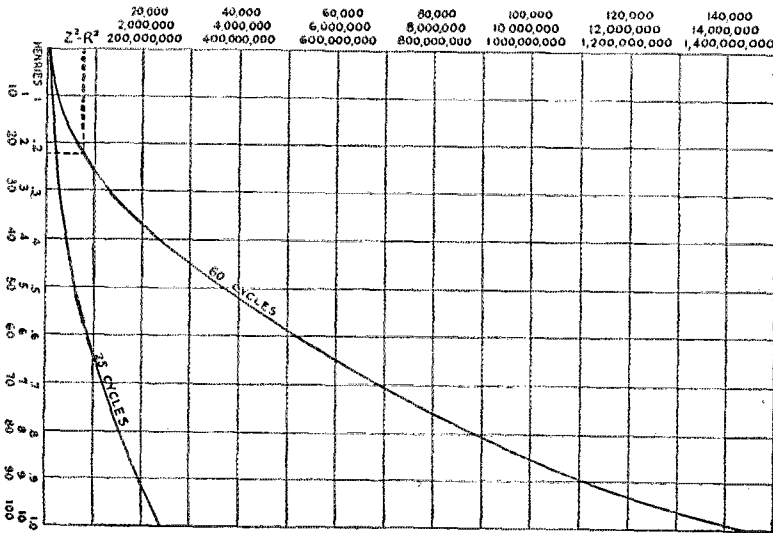

CHART FOR FINDING INDUCTANCE OF FILTER CHOKES

- 1—Find the resistance of the coil by use of Formula A.
- 2—Find the Impedance (Z) of the coil by use of formula B.
- 3—Square the resistance, that is, multiply it by itself.
- 4—Square the Impedance in the same way.
- 5—Subtract the squared resistance (R x R) from the squared Impedance (Z x Z).
- 6—Using this value of Z²-R² refer to the 60 cycle or 25 cycle curve and find the inductance in Henries at the left.

Note—If the choke has too small a core, or too small an airgap, its inductance will be lower when its windings are carrying rectified alternating current. A very "skimpy" choke may even lose ¼ of its inductance under such conditions.

even those unaccustomed to simplest algebra should have little trouble if the following examples are followed step by step.

In order to work intelligently two things about the coil must be determined. We must find, first, its resistance and second, its impedance at a known frequency. Ohm's Law, formula (A), should be used to de-

* Engineering Department, Electric Specialty Co., Stamford, Conn.

was 6 volts and the current .150 amperes. This was of course 150 milliamperes on our meter. But Ohm's Law requires that the current must be in amperes, not milliamperes. Dividing our current by the voltage as in step 1, we obtain the resistance of the coil which in this case is 40 ohms.

Our next step is to apply formula (B), and find the impedance at a known fre-

quency. The local A.C. house supply will do nicely as its frequency is usually accurate to within a fraction of a cycle. This is probably 60 cycles. There are some places where the frequency is 50 cycles, 40 cycles and even 25 cycles in this country. Anyone in a position to measure inductance should be able to find out the frequency of his local supply easily. Formula (B) looks as if we were going to do (A) over again and get the same result. The method is the same but the voltage is now alternating. The coil now shows, in addition to its resistance, a choking effect which also tends to retard the current. That is, if we were to connect our coil to a 6-volt 60-cycle supply the combination of the resistance and the choking effect would be so great that nowhere near .150 ampere would flow. In large chokes in order to get a current flow that will be within the range of the average meters it will be necessary to use a fairly high voltage. The best source is the house supply where it is A.C. Unless the coil has a resistance of at least 20 ohms as found by our first step it is not safe to put it across 110 volts house supply. In all cases a fuse of not more than 3 to 5 amperes should be placed in series with it. The actual measurements here are identical with those for (A). The instruments used here are of course of the A.C. type. In some of the smaller chokes the current will probably be large enough to be within the range of the smaller filament ammeters. If not the average High School laboratory or a local electrician should have such meters. The next step is the substitution of these values in (C). This has been laid out step by step in the example. This requires little explanation, but considerable work.

The author has quite a little of this work to do. He was born with a dislike for formulas and large figures, and with a broad lazy streak through his brain. To save both time and mental exertion he developed the following curves. Their use simplifies the mathematical part of the determination of inductance and reduces the 11 steps to 5. The highest mathematics involved is multiplication.

To use these curves:

1. Find the resistance of the coil as in (A).
2. Find the impedance of the coil as in (B).
3. Square the resistance, that is multiply it by itself.
4. Square the impedance.
5. Subtract the resistance squared from the impedance squared and use the curves.

This completes the mathematics. Now turn to the curves. Running up and down the left hand side are a series of numbers.

If the inductance of the coil is between .1 henry and 100 henries the result of the subtraction will be among them. If the number is between 1,421 and 142,100 the inductance will be in tenths of henries. That is if our number was 51,000 the in-

$$(A) R = \frac{E}{I}$$

$$(B) Z = \frac{E}{I}$$

$$(C) Z = \sqrt{R^2 + (2\pi fL)^2}$$

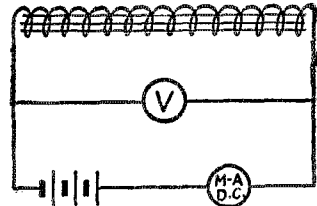

$$(A) R = \frac{E}{I}; E = 6 \text{ volts}; I = .150 \text{ Amps}$$

$$1. R = \frac{6}{.150} = 40 \text{ ohms}$$

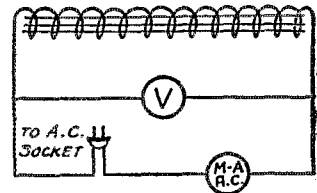

$$(B) Z = \frac{E}{I}; E = 110 \text{ V. } I = .13 \text{ Amps}$$

$$2 Z = \frac{110}{.13} = 846 \text{ ohms}$$

$$(C) Z = \sqrt{R^2 + (2\pi fL)^2}$$

$$3 Z = \sqrt{(40)^2 + (2 \times 3.1416 \times 60 \times L)^2}$$

$$4 Z = \sqrt{1600 + 142,129 \times L^2}$$

$$5 Z^2 = 1600 + 142,129 \times L^2$$

$$6 Z^2 - 1600 = 142,129 \times L^2$$

$$7 (846)^2 - 1600 = 142,129 \times L^2$$

$$8 715,716 - 1600 = 142,129 \times L^2$$

$$9 142,129 \times L^2 = 714,116$$

$$10 L^2 = \frac{714,116}{142,129} = 5.02$$

$$11 L = \sqrt{5.02} = 2.24 \text{ Henries}$$

ductance would be .5 henries. If the result of the subtraction of the squares was between 142,100 and 142,100,000 we would use the second line of figures and the inductance would be between 3.8 henries. If the number lay between 14,210,000 and 1,421,000,000 then the third column would be used and the inductance would be between 10 and 100 henries. Very seldom will there be use for the curves above 30

henries. These curves could of course be used theoretically for all ranges of inductances. It is necessary to measure the impedance of the coil at the frequency for which the curve has been worked out. If the impedance has been measured at 60 cycles it will be necessary to use the 60-cycle curve.

Let us apply our original example to these curves. We found that the resistance equaled 40 ohms and the impedance 846 ohms. Squaring both,

$$\begin{array}{r} 846 \times 846 \text{ equals } 715,716 \\ 40 \times 40 \text{ equals } 1,600 \\ \hline 714,116 \end{array}$$

On our curves 714,116 is in our middle column. The dotted line shows approximately where this is. The inductance at this point is equal to 2.24 henries. The inaccuracy in reading the meters and in the meters themselves may be greater than the error in reading these curves. These curves have given us a fairly accurate result, they have more than cut the steps in half, there is no dividing of large numbers, transformation of equations nor necessity for obtaining square roots. These curves can be easily handled by the average amateur.

Space prohibits the presentation of the mathematical development and proof of these curves. The author will be pleased to forward this information to those interested.

The 1926 Cooper Cup

MR. J. C. COOPER of Jacksonville, Fla., life member and former director of A.R.R.L. has again offered cups to be awarded for progress in amateur radio. The rules for the award have now been approved by Mr. Cooper.

The 1926 Cooper Cup

- 1—The 1926 Cooper Cup will be awarded at the close of the year 1926. It will be given for the outstanding achievement in amateur radio during the year.
- 2—Any type of work will be considered, excepting as limited by rules 3, 4 and 5. Transmission, measurement, radio surveys, reception, emergency work and theoretical work will all be considered.
- 3—Traffic handling will not be considered as there is a separate trophy for such work. Exceptions to this are made under rule 6.
- 4—Distance records will not be considered excepting under rule 6.
- 5—Efficiency records of the "watts per mile" type will not be considered except under rule 6. In general they should not be entered for this cup but for the trophy offered by the Jewell Electrical Instrument Co. of Chicago.
- 6—Exceptions to rules 4, 5 and 6 will be made if the records are made by using some improved method which can be applied to other stations.
- 7—The award will be made by a committee consisting of the Technical Editor of QST, the Assistant Technical Editor of QST and the Traffic Manager of the League, with the Technical Editor acting as chairman.
- 8—No entries will be required because it is almost certain that some of the best work would not be entered by the men doing it. The committee therefore will use the advice of a great many men in determining the award. The committee also reserves the privilege of referring the decision to a second committee of men prominent in the radio art but not necessarily members of A.R.R.L.

The 5 Meter Cup

An entirely separate cup will be awarded for work in the 5 meter band of wavelengths. This cup will be called the "Cooper 5 meter cup" and will be awarded under the same rules as the 1926 Cooper Cup.

If the outstanding amateur radio work of 1926 is in this waveband it will be possible for the same man to win both cups.

The 40 and 80 Meter Cups

The 40 meter and 80 meter cups will not be offered this year. This is partly because the two bands are not far enuf apart to warrant two cups and partly because any really important progress is just as likely to apply to all waves alike, and therefore to deserve the 1926 Cooper cup.



Tuner Design

THROUGH the courtesy of Mr. F. M. Holbrook, of 2CNS, and Mr. Richard Spamer, of the Allen D. Cardwell Mfg. Corp., we are able to present the curves shown in the accompanying figure. They illustrate the reasonable process of *making* a tuner instead of the customary one of guessing blindly at it and then wondering why the performance is not all that might be asked for.

In beginning the design of this tuner Holbrook took into account several things that are ordinarily overlooked. First of all, it is desirable to spread the band of wavelengths over which we are tuning as widely as possible on the condenser scale. Secondly (and this contradicts the first requirement), it is extremely desirable to make the tuning curve somewhere near straight. This means that we should use a large part of the condenser scale, but by no means all of it.

A receiving set was built up using a 20-turn coil and a three-plate type 159B Cardwell condenser in the secondary circuit. The coil happened to be of the old basket-wound (Lorenz) type, but exactly the same principle can be applied to the more modern spaced cylindrical winding. Using a wavemeter and the click method it was now possible to find very easily the wavelength for each setting of the condenser. After this was done for the complete coil a tap was taken at the 19th turn and another curve

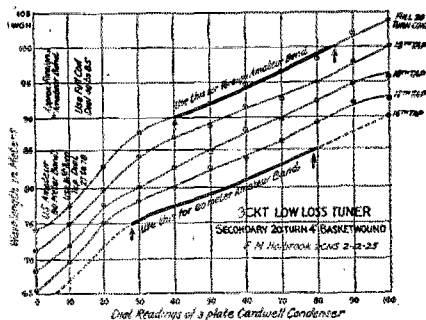

was obtained. This is the Curve B. In this way five curves were obtained altogether which required a total of 88 wavemeter readings.

Quoting from a letter of Mr. Holbrook's to Mr. Spamer: "My problem was to extend the narrow amateur band of 75 to 85.6 meters over as large a part of the condenser dial as possible. The curves showed the result of my investigation. The 88-wavemeter readings which I took are represented by the four upper curves." The first curve A is used for the foreign band of wave-

lengths, which is 90 to 100 meters. The full coil is used and 45 scale divisions (40 to 85 on the scale) are thus made available. The lowest curve, the fifth one, was sketched in this morning to illustrate that a tap on the 16th turn will give the maximum scale for the 75-meter American amateur band. You will notice that 51 scale divisions (27 to 78) are spread over this amateur band.

"Both American and foreign amateur signals fall on the straight part of the curve, making equal divisions for each equal increase in wavelength."

This work was done with condensers having plates of regulation shape. Thus only the upper portion of the wavelength scale is approximately straight. For this reason the lower part of the scale has been avoided, as tuning will be cramped there even though a slightly more favorable ratio of inductance to capacity might be considered an excuse for trying that region. The ideal way of doing the thing would perhaps be to increase the inductance slightly, to use a spaced helix of No. 20-24 wire as a secondary (so as to have the least possible distributed capacity) and then to combine with this coil a two-plate condenser of the straight-frequency-line type.

Plug-In Choke Coils

OUR friend 1XU of Pittsfield, Mass., is responsible for the keen "push-pull" choke coil shown in the photo. The winding form is a "5 & 10" tooth brush holder made of glass. The ends are threaded and aluminum caps fit these threads. In winding the chokes the end of the wire is bared and pushed over the end of the glass tube. Then the cap is screwed on over the threads and the wire. The result is that the wire is securely dead ended and at the same time makes contact with the cap. Large cartridge fuse clips hold the tube in place and make contact with the caps. 1XU has these chokes tuned to the working wavelength and for 5, 20, 40 and 80 meters has a set of chokes that he plugs in when the



wavelength is changed. No dope of any kind is put on the wire, the tightening action due to the turning of the caps as they are screwed on very effectively keeping the wire in place.

Ford Coil Filters

By Charles Provins*

I HAVE noticed attention called recently to the ever useful flivver coil and would like to suggest an improved manner I believe of utilizing all the important parts of one or two of them. I do not think that this is at all original, but might serve to remind some of the gang of the possibilities.

In all of the following filter circuits the Ford coils may be used without taking them apart, which is a disagreeable job, and also likely to damage the fine windings and the condensers.

It seems that a lot of the amateurs using them for filters¹ are using just the

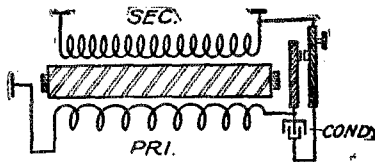

FIG. 1 FORD COIL HOOKUP

primaries which do not have much inductance and less often the secondary. The reason for using the primary is that it has low d.c. resistance, while the secondary has a d.c. resistance of about 5000 ohms; enough to cut down appreciably the plate voltage we use on 5 watters.

So far, I have not heard of anyone using the condensers which are built into the box

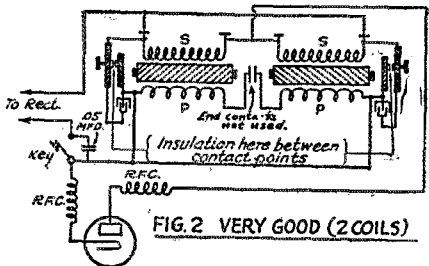

FIG. 2 VERY GOOD (2 COILS)

with the coils. These have a capacity of about one-microfarad, and, at this station stand 400 volts without breaking down, no higher voltage having been tried.

Well here is the dope:—Fig. 1 is the regular Ford coil "Hookup". The condenser is shunted across the vibrator contacts. The first thing to do is to get a thin piece of insulation to slip between the contact points; another piece might well be placed

under the lower contact arm to insulate it from possible contact with the core. The coils are not mutilated in any way.

Fig. 2 shows the circuit with two coils, the secondaries of which are connected in

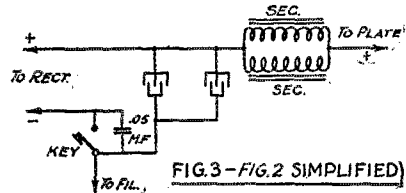

FIG. 3—FIG. 2 SIMPLIFIED

parallel. These have about 2500 ohms, resistance, which is not so "awful much" to put in series with the H. V. and of course, the inductances are in parallel but the effective inductance is still great enough to be very

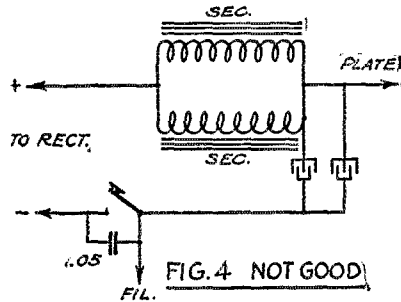

FIG. 4 NOT GOOD

effective in blocking the ripple. The negative H. V. is connected to the outer or top vibrator arm on each of the coils.

The filter circuit of Fig. 2 is equivalent to the schematic hookup of Fig. 3. This filtering action here would be the tendency of the large condensers to short circuit the

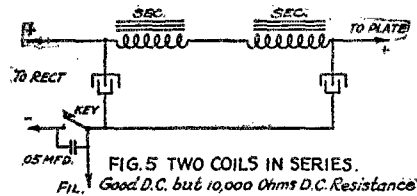

FIG. 5 TWO COILS IN SERIES.

ripple frequency coming from the rectifier and also to help fill in the so-called "valleys" in the ripple voltage; the choke blocking or removing practically all the rest of the ripple and keeping it from going through the tube load circuit.

*6DAO-6DBW, P. O. Box 671, Lynwood, Cal.
 1—Between a high voltage rectifier and a sending set.—Tech. Ed.

The parallel resonant circuit Fig. 4 was also tried but was very unsatisfactory, considerable remaining ripple being present in the D. C.—also it reduced the voltage across the plate.

Fig. 5 shows the regular type filter and gives good D. C. but also decreases the plate voltage considerably, 10,000 ohms resistance.

Fig. 6 shows another experiment using the circuit of Fig. 3 but with two more con-

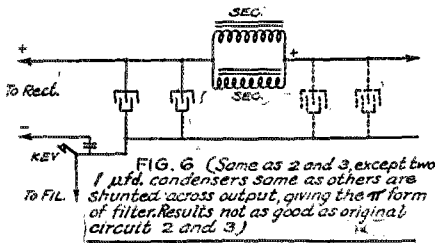

densers, taken from defunct Ford coils shunted across the D. C. at the tube side of the filter. This formed what is usually termed "pi" filter; but did not give as good results as were obtained by using the original circuit of Fig. 3 and 2.

Fig. 7 shows one coil being used for a filter. This causes quite a drop in plate

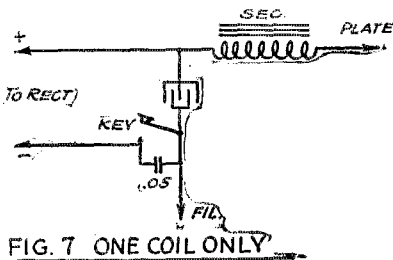

voltage but is very effective in removing ripple.

The circuit of Fig. 3 and 2 was found to give the best results.

When this filter was connected in it changed a very bad R.A.C. tone to closely approximate D. C. The plate milliammeter read nearly 50 mills without filter and a little over 40 milliamperes with filter connected. The rectifier was in very bad condition, a number of the jars sparking and some were almost "duds". (One 5-watter used).



Radio Legislation Pending

NEW radio legislation is now definitely "in the works" and it looks very much like something would come of it this time.

The Senate Committee on Interstate Commerce has held brief hearings on two bills, one being S.1, introduced by Senator Howell, the same very brief bill that Mr. Howell presented in the 68th Congress, and the other, S.1754, being a bill by Senator Dill patterned very largely on the last effort of Congressman Wallace H. White in the previous Congress, which bill at that time passed the House. The Senate committee has now discontinued hearings and it seems that they will await the action of the House, for the Committee on the Merchant Marine and Fisheries of that body has held lengthy hearings on a new bill by Mr. White, H.R.5589, which is the last word in contemplated radio legislation and which is based on the recommendations of the Fourth National Radio Conference, held last November.

It seems to us that H.R.5589 has an excellent chance of passing, with more or less minor modifications, as it has been agreed to in principle by every radio interest of which we have heard. In common with all of Mr. White's recent radio bills it avoids all technical stipulations and merely creates administrative machinery, to be directed by the Secretary of Commerce, by which the regulations governing the various classes of stations would be determined from time to time as the art progressed. Provision is made for appeal to the Court of Appeals of the District of Columbia from action of the Secretary in declining to issue a license or in revoking a license. A National Radio Commission of nine members, to be appointed by the President, would be created by this bill. The Secretary of Commerce may refer to the commission any matters the determination of which is vested in him, and their decision will be binding on him on matters so referred to them, subject of course to the same appeal as is allowed from decisions of the Secretary. Contrary to recent earlier White bills, there is no provision in this bill for fees for station or operator's licenses. In general, Headquarters regards the bill as acceptable.

An erroneous report has been circulating thru amateur channels to the effect that the bills now pending in Congress provide for depriving the amateur of the 150-200-meter band. As mentioned above, there are no wavelength assignments in any of the bills. This matter of the 150-200-meter band was decided at the national radio conference in November—in our favor.

—K. B. W.

Experimenters' Section Report

THE purpose of the Experimenters' Section is to put into touch with each other those men who are working on the same radio problems, also to help them to go at these experiments with the advantage of the experience gained by other members of A.R.R.L. Any subscriber of *QST* may be a member of the section by simply sending a request for membership to "Experimenters' Section, American Radio Relay League, 1711 Park Street, Hartford, Conn."

Please do not put *anything* else on the same sheet except your name and *complete* address. These are the only requirements, station ownership is not necessary, neither is a laboratory.

The membership blanks will then be sent, and when they are returned there will be sent a complete list of the membership together with the problems they are working on. Some problem outlines are now available and more will be made.

Our Immediate Future

It has been felt for some time that the Experimenters' Section deserved more time than could be given to it by the Technical Editor or the Assistant Technical Editor. At the same time we have not been in a position to employ a man for that purpose alone.

It has now been decided to try combining the desk work of this section with that of the A.R.R.L. Information Service. This arrangement is made possible by the fact that Mr. L. W. Hatry, who has been handling the Information Service on a half-day basis, is leaving us to devote his entire time to free-lance writing and to the radio activities of the Hartford Times.

Under the new plan the Experimenters' Section and the Information Service will retain their separate existences as offshoots of the Technical desk, but the daily work of both will be handled together. The work will be done by Mr. Harold P. Westman, who is introduced elsewhere in this issue.

This change creates the possibilities for more active advance of this section and the Technical Editor hopes to see these possibilities developed during the coming year.

The WGY Tests

The results of the various WGY tests are not fully known here at this writing. Letters have been received from observers who are also members of this section, but most of the information has gone directly to Schenectady, where it is being combined with information from other sources. The writer will shortly visit the South Schenectady laboratory and return with a report. This should appear in the April issue.

The Outlines—Again

Some outlines have now been started "thru the mill". Others are being written in the field. The main difficulty has been to say enough in the outlines without making them so large that we cannot mimeograph them. The circuit diagrams and curves are a difficulty also as they are difficult to draw accurately on the uncertain mimeograph paper. Where it becomes necessary they will be drawn on tracing paper and blue-inked.

Horizontal Reception

The issue of *QST* carrying the story of Dr. Pickard's work has only just left, hence no reports are in as to the results from Horizontal reception. As many as possible are wanted, especially for the 20 and 40-meter band. 20-meter results are most important. Both measurements and reception reports are needed.

Long Antennas

A good bit of interest is being stirred up by the success of some stations that have put up very long receiving antennas. The successful ones seem to be very long *and* also quite high. At the same time other antennas of the same type have been complete failures in comparison with smaller antennas. Some very long and low antennas have also been put up but here the successes have been less on the whole.

It will be interesting to determine if these antennas act as horizontal antennas and if they are very directional or not. It will also be interesting to notice which wave bands each receives best, also from what direction and at what hours. If you know of anyone using such antennas please send in his name so that details may be gotten.

Synchronous Rectifiers

Astonishingly little seems to be known about synchronous rectifiers working into a filter. A group of different ones is being tested at the writer's home and it has been quickly apparent that the difference in ease of filtering is rather large.

Small Transmitter Plate Supply

As indicated in the "battery substitute" article of last month it is possible to operate a small transmitter from any of the battery substitutes which supply a voltage of 100 or higher. It has been found possible to modify the filter of several of these devices so as to get a higher plate voltage with some slight sacrifice in smoothness of output—just enough to make the tone pleasant to read. Have others tried this thing? If so let us know about it.

—R. S. K.

Finding the Plate Resistance

MR. W. P. MUIR of 611 Wilson Avenue, Montreal, Quebec, Canada suggests a simple method of finding the plate resistance of a detector tube when no instruments are available that are sensitive enough to measure the plate current.

Nothing is needed besides a receiving set with a tickler, two sources of B battery voltage (one of them several times the voltage of the other one) and some high resistances whose values should be known.

The connections are made as shown in the diagram. The switch is placed on the lower point and the tube is adjusted until it will just oscillate when the switch is opened and again closed on this point. A lower voltage will not make it oscillate, a higher one will make it oscillate without opening and closing the switch. It is necessary to make the tickler adjustment carefully.

Now move the switch to the other point and change the series resistance until the tube will again just oscillate when the switch is closed. It is evident that the voltage supplied to the tube is the same, no matter which way the switch is placed. Therefore the drop through the series resistance is the same as the difference of voltage in the two batteries. If one of these batteries is a 45 volt one and the other a

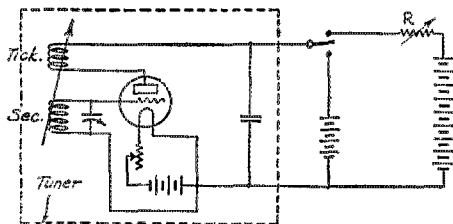

FINDING THE PLATE RESISTANCE OF A TUBE

90 volt one it is evident that there must be a 45 volt drop through the series resistance. If the resistance is known one can calculate the current fast enough from Ohm's law. One then knows the voltage at the tube and the current through it, after which the plate resistance is simplicity itself.

It is very convenient to do this thing with a continuously variable resistance such as a "Bradleyohm" having a range of 50,000 to 500,000 ohms but one must of course be able to transfer it to a Wheatstone bridge and measure its value.

The accuracy of the whole business is as good as one's knowledge of the battery voltages and the resistance R. Battery volt meters are common, cheap and—if they

cost more than 98c—accurate Cartridge fixed resistances are cheap and the manufacturer's statement of resistance is usually dependable if he gives any "percentage accuracy" rating. For approximate work one can use "lavite" resistances and the like. Grid leaks are usually not dependable.

For Short-Wave Tuners

BROUGHT out especially to fill the demand on the part of amateurs for a small-maximum-capacity variable condenser, the Karas orthometric is now available in the 5 plate size. This condenser has a maximum capacity of 97 μ fd. and a

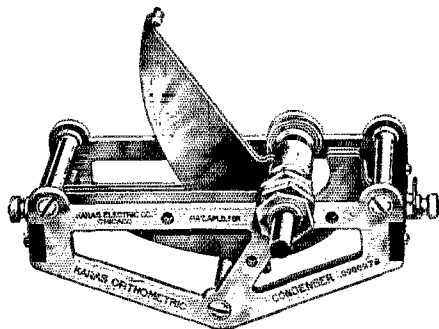

minimum of 9.6 μ fd. It is of the straight-line type which spreads the ham stations all over the dial as they should be. The constructional features are the same as found in the larger condensers; soldered stator and rotor plates of brass, heavy skeleton brass frame, hard rubber strip insulation properly placed, good bearings and last but not least an insulated pig-tail connection between the rotor plates and the frame. A nice addition to any ham tuner.

—J. M. C.

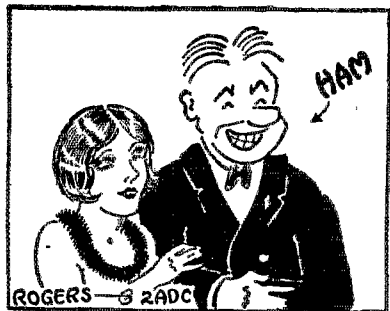

SHE. "Oh John, I wish you'd quit this amateur game and turn "pro". See how much money Red Grange made.

THE RECEIVING EXPERIMENTER

Receiving Without a Grid-Leak

Receiving without a gridleak has its advantages. For one thing the set recovers *instantly* from static crashes, street-car "plops" and overly-strong signals from near-by sending stations. Another, and much more important thing is that better sensitivity can usually be secured. Perhaps this is because the C-battery scheme, shown in the figure, usually works on the lower bend of the detector curve, instead of the higher parts as is the case with the leak-and-condenser combination. This does not give greater amplification and therefore is not ideal for strong signals but it does give *excellent* detection of weak signals.

Whether that explanation is right does not matter. The fact remains that superior sensitivity is obtained in practice.

—A. L. B.

A Tickler Mounting

Did it ever occur to you that the National Velvet-vernier dial automatically supplies the necessary bearing for a tickler coil? The dial costs two dollars and a half but

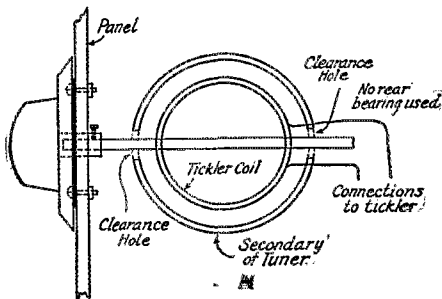

it's worth that to get out of the usual fuss with the rear bearing of a tickler shaft. The action is beautiful. The sketch explains how the thing is done.

—F. C. B.

Coil Cement

G. L. Bidwell, former Director Atlantic Division A.R.R.L., advises that coil cement can be made of old cleaned photograph film dissolved in a solution which is one-half acetone and the other half amyloacetate. If the solution is made with acetone alone the resulting film is porous and will let in water. If made as directed the film is quite waterproof.

What is meant by cleaning the photograph film is that it should be put into

warm water long enough to slide off the sensitive material and its gelatin area, thereby leaving the perfectly clear celluloid which had better be washed thoroughly before being used to make the coil cement.

The Glue on the Grid Leak

There appears to be a good deal of reason for thinking that much of the noise found in grid leaks can be blamed on the gummed label on the outside of the leak. In damp weather the glue becomes quite moist and if the label is almost the length of the leak this puts another leak parallel with the first one. Since the second leak is an uncertain proposition noise results.

Paper Tape on Coils

It seems to be quite general practice to fasten coils together with gummed paper tape. This is exceedingly poor practice because the glue when moist is a good electrical condenser and also it attacks the copper chemically. The Thordarson Electric Mfg. Co., a few years ago made some experiments which showed that audio frequency transformers could very easily be ruined by using a couple of inches of this stuff at the wrong place. It hardly pays to make a coil carefully and then to glue a strip of paper along it. The result is a decidedly poor coil every time that it rains.

Strays

8IH found that his antenna current jumped from 2 amp. to 3 amperes when he removed the nice brass supporting frame from his 80 meter transmitter. He claims that none of his inductances or leads were within four inches of the frame, too; and that a nice fat spark could be drawn from it.

The DeForest H tube requires a rather high resistance grid leak, usually around 60,000 ohms. Ordinarily a leak of this kind is hard to find. The Crescent Radio Company of 1 Liberty Street, Jamaica, N.Y., makes two special Lavite resistances on a nice bakelite base just for use with the H tube.

8KX tells us that a moulded bakelite socket, minus all hardware, makes an excellent rigging for the DeForest H tube. Shove the grid end of the tube into the socket, and bring out the grid lead through the pin slot in the side of the socket.

George E. Swartz of San Francisco is installing a testing lab in the Mission High School and offers the use of the lab for radio construction, research or testing to all hams. The lab is thrown open free of charge to all who really mean business.

Who's Who in AMATEUR WIRELESS



LAWRENCE J. DUNN, 2CLA



DR. LAWRENCE J. DUNN, 2CLA, of New York City, was born in New York in 1893. He was first exposed to radio in 1908. He attended Stuyvesant High School from 1909 to 1913 during which time he was a member of the Stuyvesant Radio Club. He graduated from the University of Pennsylvania with a D.D.S. degree. His first amateur license was secured in 1912, followed by a commercial license in 1913. During the war he served as a First Lieutenant in the Army Dental Corps, resigning in 1919. He accepted an appointment as Captain in the Officers Reserve Corps in 1925. In 1920 he entered private dental practice. Doc was elected Hudson Division Manager in 1924 and was President of the Radio Club of Brooklyn in 1924-25, and also served as the Director of the Y.M.C.A. Institute in 1925.

BRANDON WENTWORTH, 6OI

THE operator behind 6OI, one of the best stations on the West Coast, is Brandon Wentworth. The war came along just as he got his first ham license so activities were postponed until 1921 when he started up with a 1 K.W. spark, at Santa Barbara under call 6AIK. Late in this year he and 6AAK combined and had one of the best spark sets known. In 1922 Wentworth moved to Montana where 7VZ came into being. Later he moved to Boston where he was second op at 1BAN whose sigs were among the first to be logged in France. He went back to California in 1924 and located at Stanford where the present 6OI is operated. Wentworth is studying at Stanford University and is operator at 6XBM, the Bu Stan station at the University.



E. W. THATCHER, "GX" OF SZE



GX", otherwise E. W. Thatcher, Chief op at Oberlin College, Oberlin, Ohio, started life at Jefferson, Ohio, in 1904. In 1908 he was moved to Oberlin and from 1914 to 1916 started with a half K.W. and open gap. After the war he opened up with 8GX and used to do 1,000 miles regularly, even being heard in California. In 1921 6AWP sprung into prominence when Thatcher moved to California. A year later "GX" returned to Oberlin where he graduated in June of last year. He is now studying for a M.A. in Physics and has been Chief op of 8XT (experimental) and SZE (known all over the world) since 1923. Thatcher is also assisting in the Physics lab at Oberlin, and is particularly active in the radio course offered by that college.

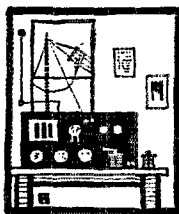

Amateur Radio Stations

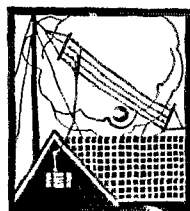

6HM, Carmel, California

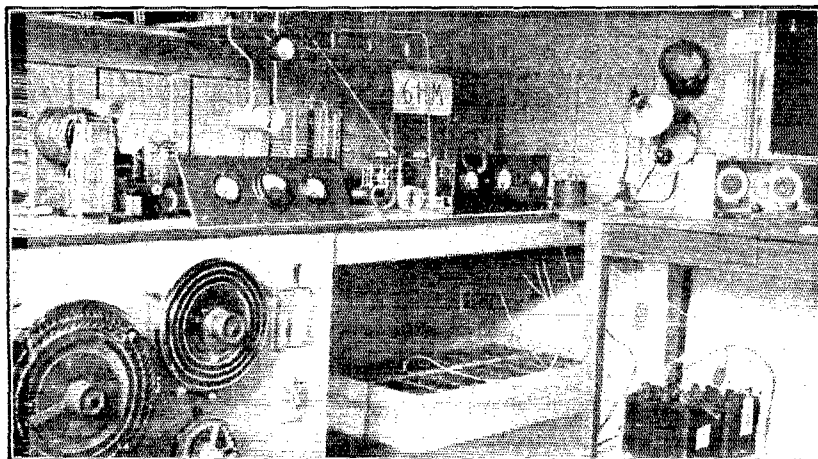

THIS is the well-known station of Colonel Clair Foster erstwhile c9CK. The station is operated by the Colonel and by Harry Lyman of 6CNC. Lyman is responsible for the very excellent design and construction and we are going to tell the story in his own words.

"Having tried out practically all of the well known circuits and various adaptations of them, I give herewith an arrangement of the Armstrong tuned-plate, tuned grid circuit that has proved the best I have found thus far. Even the KFUH arrangement (see *QST* for November, 1925, page 15) could not be made to measure up to the arrangement here described.

"The transmitter can be made either series or parallel feed. In practice parallel feed was found best. The load in the LC circuit, always heavy, is not so great in the parallel feed arrangement. In the LC (tuned) portion of the plate circuit, the resistance must be kept as low as possible. Fig. 1 shows the general layout. It is necessary, of course, to provide L2-C2 before the set will function, but they are not the controlling factors of the frequency and are not especially critical in adjustment. As the two circuits are connected only through

small capacities, small changes in L2-C2 do not greatly affect the LC circuit (Note—to get good stability it is necessary to make C2 and C1 large, therefore L2 and L1 must be small).

"The coils are of copper tubing of one

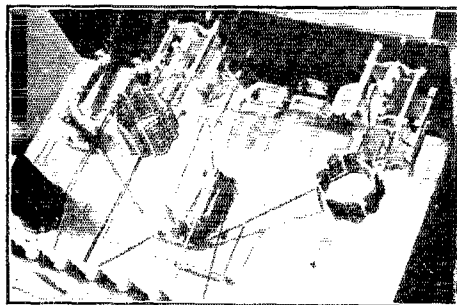

DETAIL VIEW OF 6HM'S RECEIVER

quarter inch outside diameter. A piece of two inch pipe was used as the winding form. Nine turns are used for a 40 meter wavelength and three turns for 20 meters. Special attachments are used between the brass-rod uprights and coils to facilitate

quick changing from 40 to 20 meters (These attachments appear to be compression unions such as are used to connect automobile gasoline and oil lines). They are mounted

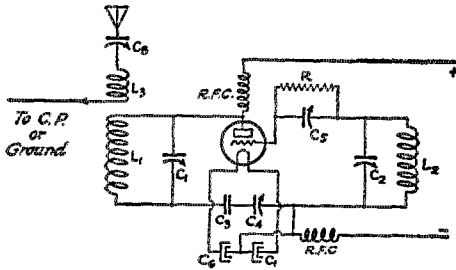

FIG. 1—THE TRANSMITTING CIRCUIT

C1—Home-made plate tuning condenser, 700 ufd, one-quarter in spacing.

C2—Grid tuning condenser, 500 ufd, double spaced.

C3—Plate stopping condenser, 7000 volts, 500 ufd. Place at filament end of plate coil to avoid loading circuit.

C4—Coupling condenser, 250 ufd., usually set at about 25 ufd. Ordinary transmitting V.C.

C5—250 ufd. receiving condenser used as a variable grid condenser.

C6-C7—Filament transformer by-pass condensers, 1 ufd. each.

C8—Antenna series condenser. Use proper size to suit antenna.

L1-L2—Coils of quarter inch copper tubing wound 2 inches in diameter with 9 turns for 40 meter wavelength and 3 turns for 20 meters.

L3—Same construction as L1-L2, but only 5 turns.

R—Grid leak.

RFC—one and one-quarter inch diameter wound with No. 30 D.S.C. and tuned to working wave by click method. 140 turns for a 40 meter wave.

up in the clear so as to keep other apparatus out of their fields as much as possible; and, as will be seen in the fotos, are supported only at their ends. Various spacings of turns were tried out. The best all round results were obtained with spacing equal to the diameter of the tubing.

"The antenna coil has 5 turns, coupled at the stronger-field end of the plate coil. The coupling, as it appears in the fotos, may seem too close. In the arrangement of this particular set, at least, the closeness of coupling does not affect the wave, reports invariably being "steady". In fact they remained just that even when a series condenser was switched into the ground lead or when the antenna was walloping about in the wind. In passing, it may be remarked here that the use of D.C. plate supply is contemplated at this station.

"The large variable condenser (C1) in the fotos, is a homemade affair with quarter inch spacing between rotor and stator plates. Its maximum value is about 700 ufd. For plate voltages up to 2000 R.A.C. the ordinary double-spaced condenser function at this point without arcing, but with

2500 A.C. on the plate this specially constructed condenser was found desirable. C2 is an ordinary transmitting condenser. C3 is a fixed stopping condenser made to stand 7000 volts. C4 is a 250 ufd transmitting condenser, set usually at nearly minimum capacity. These two last named condensers could be replaced by a fixed condenser of 25 to 50 ufd. The grid condenser in the transmitter is a variable transmitting condenser of 500 ufd. The use of a variable condenser here was found to be of considerable advantage. The small variable condenser shown on the shelf above the transmitter is a series condenser in the ground lead; used merely to vary the fundamental of the radiating system for working at a wavelength of 20 meters. For 40 meter operation a switch shorts this condenser. The R.F. chokes were tuned to the working wave by the click method with the receiver. For 40 meters they are wound with 140 turns of No. 30 D.S. C. on one and a quarter inch glass tubing. They will handle up to 200 M.A. For heavier loads larger wire should be used.

"Fig. 2 indicates how L1 and L2 interact. The large end of the field especially should be clear of all interference. The fields are largest at plate and grid ends of coils. Fields are of the form shown, as can be determined by tracing their outlines in any plane by the use of a neon tube or galvano-

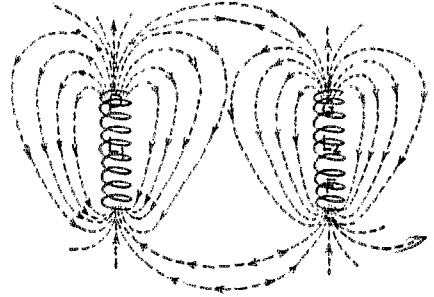
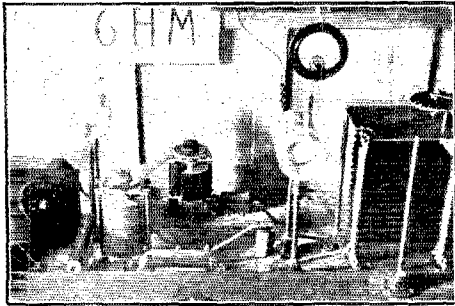

FIG. 2
INTERACTION OF PLATE AND GRID COILS
Fields plotted as shown in Fig. 3.

meter. (See Fig. 3). The galvanometer will show just where the intense field exists and what may be interfering with it. This matter of shape and extent of fields should be of interest to anyone contemplating building a set, and should assist him in laying out the parts.

"The receiver shown in Fig. 4 is the best of a great many short wave sets built and experimented with. The circuit is similar to that of the transmitter just described,

with the exception of the use of C4, 500 μ fd having been found best when using the W.E. peanut tube. For receiving in the 40 meter band L1 has 15 turns of No. 12 enameled wire wound in a two inch circle. The turns are spaced at crossing of wires by



DETAIL VIEW OF 6HM'S BIG TRANSMITTER

linen string boiled in paraffine. L2 has nine turns wound the same as L1. For 20 meters the coils are of six and five turns respectively.

"For this receiver coils were made on a cylindrical form, with turns carefully spaced. Comparative tests were made to find out which functioned better, the cylindrical or basket-weave coil. The basket weave won out. The coils, as will be seen in the fotos, are attached to small binding posts set in holes drilled and tapped in stator and rotor parts of the condenser frames. Making the coils of heavy wire made it possible to support them from binding posts without other support; and

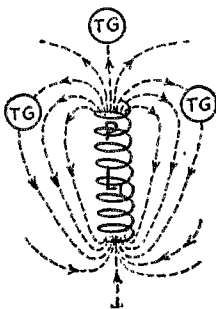

FIG. 3

PLOTTING FIELD ABOUT PLATE COIL

TG is a thermo galvanometer with a pick-up coil. The broader field at high voltage end of coil is due to the static field which is superimposed upon the magnetic field.

to keep them at a safe distance from the condensers without danger of mechanical vibration. The R.F. choke has 200 turns of No. 36 D.S.C. on a short piece of quarter inch dowel.

"The experimental work on the design of both of the transmitter and receiver was done both at my own station 6CNC and at 6HM. The transmitter described is the larger of two sets at 6HM and the receiver is one of several in use there. I visited 6HM continuously for six weeks while Colonel Foster was in the East, with carte blanche to do as I pleased and with no limit set on the apparatus I might acquire. With nothing but raw A.C. on the plate of a 250 watter the following 142 different stations were worked, all in the month of November and by one operator alone,—and I am a poor operator, at that: United States 14 Ones, 14 Twos, 8 Threes, 10 Fours 9 Fives, 6 Sixes, 4 Sevens, 11 Eights and 24 Nines; Canada 1, Hawaii 4, Brazil 1, Argentina 4, New Zealand 8, Australia 7, Tasmania 1, Sweden SRD, So. Africa A4Z, NKF, NAH, GDVB and AQE.

"Eleven of these stations were worked on the 20 meter band, the rest on 40 meters. All of these stations worked within one

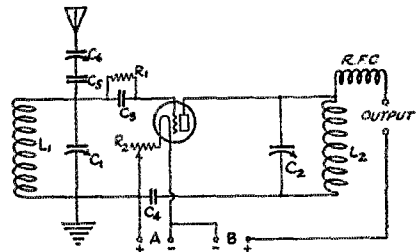

FIG. 4—THE RECEIVING CIRCUIT

- C1—Four plate variable condenser. Capacity about 100 μ fd.
- C2—23 plate variable condenser about 500 μ fd.
- C3—50 μ fd. mica-tinfoil grid condenser.
- C4—500 μ fd. plate stopping condenser same as above.
- C5—Antenna coupling condenser. Two pieces of brass about one-half inch by three-eighth inch spaced a quarter of an inch.
- C6—External antenna series condenser. Used to shift antenna tuning in case this is necessary.
- L1—No. 12 enameled coil two inches in diameter, spaced winding. 15 turns for 40 meters, 9 for 20 meters.
- L2—Same as L1 but six turns and five turns.
- RFC—300 turns No. 36 D.S.C. on quarter inch dowel.
- R1—1 megohm grid leak.
- R2—Bradlerstat filament rheostat.

month, with a raw A.C. note and by a poor operator, speaks rather well for the transmitter and receiver in use. Just wait until this station gets on the air with an NKF note.

"Various radiating systems were tried out. After each change of system the reports were practically all, "no change at all in sigs". The one that was finally adhered to for 40 meters was a two-wire third harmonic affair, and a ground. Although working through worst time, in the evening when the power is fluctuating, the sigs were reported steady without exception."



I.A.R.U. NEWS

Great Britain

THE month of December has been a most disappointing one as far as DX goes, and taking into account the great success achieved in the two previous years in the 100 meter band, one is led to think that either hams in general are getting slack or losing keenness. g2NM has been on the air most nights from 6 to 2 without even hearing a single DX station of any description. We think that that is getting serious, and one must surmise that signals in the 40 meter band do not come through in winter as they do in summer. Communication has been established with the Philippine Islands on one occasion by the writer and a very good QSO it was. It is a pity, though, that the "pi's" are so anxious for traffic handling because this is absolutely forbidden to most European hams, especially in England.

g2NM has been in regular communication on fone with India and Egypt during the month. Good rebroadcasting of 2NM's fone signals furnished by the London B.C. stations has been heard in all parts of the world. A Continental Church Service was rebroadcast on one occasion and picked up in India. 2NM's chief achievement of the month has been in his QSO with c8AR of St. Johns Newfoundland. It is especially urged that all hams take matters seriously when they make definite schedules, and by all means observe the schedules. Owing to England's geographical location the "g's" often sit up until the wee hours of morn waiting for some schedule, only to find their man has fallen down. The Z stations are coming on the air again and Benzie of x2BG at Udarband is heard on 34 meters and has already QSO'd G's. Also 2HP at Ajmer, India, comes in well on about 23 meters. We are all still very keen here and are hoping for a revival of the good old DX days now that the year has changed. It seems to us that 40 meter waves are the best for summer work, as far as the U.S. is concerned, anyway. Shall we go back to 80-90 meters for winter DX?—*G. Marcuse, President, British Section, I. A. R. U.*

Germany

"On the 16th and 17th of January a Congress of the German transmitters was held

in Jena. At the head of this Congress was Dr. Esau, the chairman of the German section of the I. A. R. U. As leader of the transmitters we have Mr. Stockmayer, the chairman of the upper German Radio Society of Stuttgart and Secretary of the German Section of the I. A. R. U. The communications leader is Mr. Rolf Formis of Stuttgart. The meeting had as its purpose the organization of German transmitters. The German transmission has until now made good progress, although transmission is still not unrestricted by the Postal Department. Transmitting licenses are being granted under an obsolete law. Germany now has 123 transmitters, of which number 42 are amateurs. These last are in contact with each other through the service of the Communication Bureau. An arrangement has also been made whereby those who receive only may get into contact with the transmitters. Each German receiver is assigned a number. A large number of foreigners are finding this a very convenient method of contact with the receivers and transmitters. The interests for obtaining a more free issuing of transmitting licenses

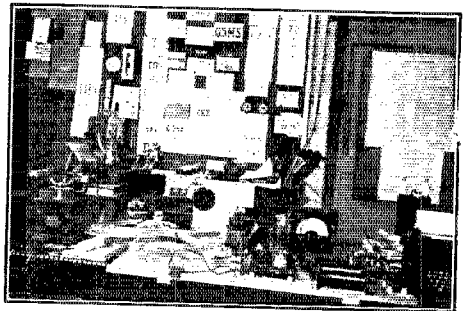

KY4, STUTTGART, GERMANY

are being continued and probably will bear fruit soon. Although transmission in Germany is young, there is already much complaint that QSL cards are being answered much too slowly. We request earnestly that those who receive report cards from any station answer them as soon as possible."—*L. V. Stockmayer, Sec'y, German Section, I. A. R. U.*

We are showing herewith a photo of station kY4, the DX outfit of Mr. Rolf Formis, Stuttgart, Germany. The transmitter uses either a single Telefunken tube with 48 watts input or a 500 watter, both working in a coupled Hartley circuit. With the smaller tube all of Europe is worked with little trouble. The receivers (not shown in the photo) consist of a 10 to 150-meter "Schnell type" with two stages of audio frequency amplification, a long wave set using one stage of r.f., detector and two of audio and tuning from 150 to 15,000 meters, and lastly a loop set with four stages of r.f., detector and two of audio tuning from 1,500 to 25,000 meters. Two wavemeters are available, covering wavelengths from 20 to 7,500 meters. Mr. Formis is an active relay man and can handle traffic in German, French or English. He is one of the pioneer amateurs of Germany and is responsible for a lot of progress that is being made in that country.

Pierce of 1AXA supplied us with the photo of kY5, the station of Mr. F. Sabrowsky also of Stuttgart. kY5 was one of the first

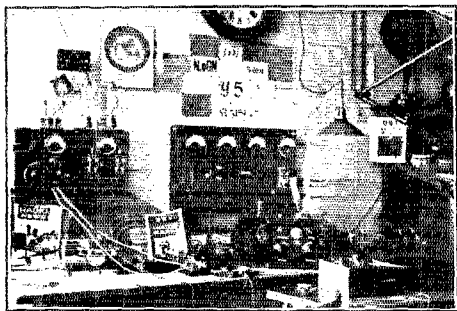

KY5, ONE OF THE FIRST GERMAN STATIONS QSO THE U. S.

German stations to be QSO the U.S. and since his original contact with u1AXA he has been doing some very nice work. We do not have many particulars regarding the station. The tubes appear to be type RS 5 (Telefunken) and the short wave receiver looks like a pip of a job. Sorry we haven't more information concerning the station itself.

Switzerland

"There are about thirty amateurs with transmitters in Switzerland. One of the stations is licensed and the others are on the road to securing licenses, having partly passed the official examination already. Others are experimenting in order to be able to pass successfully the pretty stiff examination given at Berne.

Starting on November 13th the officials of the Swiss Telegraph Office at Berne swept down upon the amateurs and, with the aid of the police, confiscated the transmitters of ten of the best ham stations in Switzerland,

i.e. of those who had already applied for examination and were known by name to the authorities. They even confiscated the apparatus and correspondence of the licensed operators, took away their QSL cards and gave them no end of trouble. And all of this without giving any reason whatever. The only thing said to the amateurs was, "You have been in communication with foreign amateurs, as is proven by your QSL cards. This cannot be permitted." What do you American OM's think of such a procedure? Perhaps you will be able to enlighten us as our own lights are insufficient to penetrate this dense fog which descended on us from the Berner Oberland! Here we are, grouped by an official order of the Telegraph Administration, in a Union of Swiss Amateur Transmitters, have to pay good dollars in order to pass most severe examinations, as are only demanded of the operators of the telegraphic service, then again we have to pay many more good dollars in order to get a license to put up our transmitters, and after we have done all this they come and fetch the police and treat us worse than goalbirds! This happened in the year A. D. 1925, in the free Republic of the Swiss Confederation, the home of the League of Nations in its fifth year of existence. This story of superb bureaucracy is worth being recorded in the annals of the world's amateur radio movement. You can imagine that the feelings of the Swiss Radio Clubs are running pretty high. It really seems funny that the Swiss Telegraph Administration does not seem able to understand the importance of the amateur's short wave work. I do not wish to say any more in this matter for the present as I hope that understanding and good will will come soon so that we may be able to do our share in the development of short wave radio. Amateurs have been working pretty hard here on short and very short waves with very little energy. Let us hope that this new year will bring more luck to the Swiss amateurs and that this situation will be cleared away quickly.—*J. Noelting.*

Japan

The training school of the Department of Communications, Shiba Park, Tokio, Japan, has recently done some remarkable DX short wave telegraph and telephone work. The station signs j1PP. Originally it was on a 20 meter wave but as some trouble was experienced in raising the gang, the wave was shifted to 35 meters, after which no trouble was had in working both ends of the globe either on telegraph or telephone. The transmitter (photos of which are shown) consists of a one K.W. oscillator with tuned plate circuit and two 500 watt modulator tubes together with the speech amplifier which is a 5 watt tube. A casual glance at the photograph will show the very excellent construction employed in the assembly. j1PP

will be on the air every evening except Sunday with voice, music and telegraph and will attempt to rebroadcast programs from JOAK, one of the Tokio Broadcasting Stations. QSO with anyone will be appreciated and any information as to signal strength steadiness and so on, when mailed to the above address, will be gratefully received. It appears that u9DNG was the first "u" station to work j1PP. Communication was carried on both by fone es telegraph on

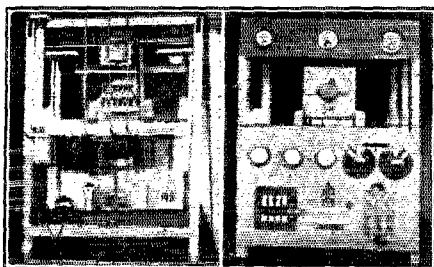

THE HIGH POWER TRANSMITTER AT J1PP,
TOKIO

December 21st. c5HW reports 1PP's signals and FX1 at Honolulu worked him on December 22nd. 9CKP reports hearing stations signing J7S, JADP and JWA in the 80 meter band. QRA?

New Zealand

Through u5ZAI we received the following news from z2XA: "Conditions in New Zealand very unfavorable last month or so due to bad QRN. Satisfactory QSO with louder stations only. International hams should look out for AQE, the whaler *Sir James Clark Ross* now fifteen degrees from the South Pole, 500 cycle note on about 38 meters. German stations are being heard but up to present time no New Zealand station has been QSO this country. We are all anxious to be in communication with South Africa but unsuccessful to date. A great number of low power stations in New Zealand have been QSO Hawaii and the West Coast of the U. S. Several "z's" have been working fi8QQ in Indo China. He is just below 36 meters and has ripply d.c. note. j1PP in Tokio, Japan, has been heard a number of times in New Zealand, sigs QSA vy. z2XA was QSO SDK, a Swedish Ship, when she was 200 miles north of the Azores, reporting 2XA's signals "FB". KFUH at present is in Auckland, New Zealand, and a number of the fellows have had an opportunity to meet that crack operator, Roebuck. They found his personality on a par with his operating, but they are keeping all their YL's under cover until he leaves! To which we can add a message received from z3AF, also via ugZAI: "Among the five watters who work

the U. S. and Europe are 4AL, 4AV, 3AD, 2BL and 2BR. High Power is the bunk in New Zealand these days. z3AM has changed hands pending the arrival of a 250 watter. z3AM is using two five watt tubes and is anxious to arrange schedules with U. S. hams. z2AE is in Australia for a while but is not quitting the game. We have some five meter experts including moonshine 7BCL who makes a fifty watt tube perk on a wavelength of 20 centimeters. Withers of z3AM sails for San Francisco in February. z3AO busted his 203 and now a YL has got him."

Australia

First two-way communication between Australia and South Africa was carried on by Maclurcan of a2CM at Sydney and Streeter, oA4Z, of Johannesburg, at 1700 GMT on December 11th. Contact was held for over an hour during which time a message was sent to the Prime Minister of South Africa from Australian Wireless Experimenters. This QSO was in the 40 meter band. Fine Biz! Via 9ZT the following came in from a2YI: "QRA of VKP is the experimental station of the Royal Australian Navy, Westernport, Victoria. He has just opened up and is going to test every evening and will increase power to 1500 watts in the antenna soon." Wallace reports hearing VKP working a 2YI the same morning that the above was received, and VKP tells a2YI that he is the first station he has been QSO.

South Africa

The most impressive achievement, part of which was due to South African amateur radio, which has happened recently is the 22,000 mile relay from fi8BLT at saigon, French Indo China to bz5AB. The message passed from fi8BLT to NUQG, the *U. S. S. Pillsbury* in China, to pi1HR in Honolulu and from there to g2LZ, the station of friend Mayer in London. g2LZ being unable to QSR to any Brazilian station, the msg was passed on to Streeter of oA4Z in Cape Town from whence it went to oA4L who gave it to bz1AF in Rio de Janeiro. The latter gave the message direct to bz5AB. Twenty-two thousand miles!

Australian-U.S. Tests

Under the auspices of the Wireless Institute of Australia, preliminary plans have been completed for a series of "reliability" tests to take place in April. On the evening of April 2nd the Australian stations will call "CQ America" between 1900 and 1930, and endeavor to connect with American stations. As soon as the Australians have established QSO, they will send a message to the U. S. station, and will request a message in return. Schedules will be made between the two stations for a continuation

of the above, and an effort will be made to see how many nights during the month of April contact can be established and messages handled. The Australian station that secures a complete message on the greatest number of nights during this month will win a cup donated by H. K. Love, President of the Institute. Watch for em gang, starting April 2nd!

Russia

C. W. Bailey on the NTT in Italy recently was QSO RXE who asks that all of the gang hearing RRP pse send QSL's to the station. It is the beam transmitter of the Radio Laboratory, Nijni Nowgorod, Russia. QSL cards should be addressed to the attention of Mr. W. Petrow. We understand that there are no licensed amateurs in Russia at this time.

Miscellaneous

Some new stations have turned up recently. 6HM worked yJCP, J. K. Primavtzi, N. York Street, nr 1590 at Montevideo, Uruguay, and was followed by 9VO who was QSO this station two days after 6HM was. 6HM also reports working rDB2 and rDXI either of whom can be QSL'd care Dr. Cattaneo, Bahia Blanca, Argentina. 6HM was also QSO SRD, Reodea Laboratory, Jonkoping, Sweden. Jackson of 1CMP reports several new fellows whose QRA we would like to have. They are. P2DT, p3GB, na3NZB and buZ1. QRA? QRA?

npC2B requests QSL's to his transmissions on wavelengths around 5, 20 and 50 meters. The operator, G. van Beusekom, Julianlaan 4, Delft, Holland, is collecting data for a paper for the Technical University and will appreciate it if all QSL's will contain as much data as possible concerning weather conditions, signal strength, wavelength and so on.

Short-Wave Stations

Through the courtesy of L. A. Briggs, Chief Operating Electrician of the R. C. A. we are presenting herewith a list of some of the more prominent short wave transmitters, commercial and a few Naval. Due to the experimental nature of many of the stations listed below the accuracy of this list cannot be guaranteed. At the time it was gotten up it was commercially accurate, however.

Wave-length	Frequency in kc.	Call	Location
13.5	22209	POF	Nauen, Germany
14.93	20082	2XS	Rocky Point N. Y.
15	19988	2XAW	Schenectady, N. Y.
16	18738	POF	Nauen, Germany
16	18738	NKF	Anacostia, D. C.
18	16657	POF	Nauen, Germany

20	14991	2XAD	Schenectady, N. Y.
20	14991	POF	Nauen, Germany
20	14991	NAL	Washington, D. C.
20	14991	NEPQ	USS Relief
20.8	14414	NKF	Anacostia, D. C.
22	13628	WIK	New Brunswick, N. J.
25	11993	2YT	Poldhu, England
25	11993	POY	Nauen, Germany
25	11928	FW	Sainte Assise, France.
25.5	11758	NKF	Anacostia, D. C.
25	11532	AGA	Nauen, Germany
27.5	10908	PCMM	Kootwijk, Holland
28	10708	PWW	Nauen, Germany
30	9994	2XI	Schenectady, N. Y.
30.6	8798	NAL	Washington, D. C.
32	9869	2YT	Poldhu, England
32	9869	ANE	Malabar, Java
35.03	8560	WQC	Rocky Point, N. Y.
36	8294	PCMM	Kootwijk, Holland
38	7890	PCUU	Kootwijk, Holland
40	7496	NAS	Pensacola, Fla.
40	7496	NAJ	Great Lakes, Ill.
40	7496	NPQ	San Francisco
40	7496	NQW	USS New Mexico
40	7496	2XAC	Schenectady, N. Y.
41.8	7260	NKF	Anacostia, D. C.
41.88	7160	2XAF	WGY—Schenectady
42	7139	5XH	New Orleans, La.
42	7139	FW	Sainte Assise, France
43.02	6970	WIZ	New Brunswick, N. J.
44	6814	WQC	Rocky Point, N. Y.
44	6814	KZA	Los Angeles, Cal.
44	6814	KZB	Los Angeles, Cal.
46	6518	PCLL	Kootwijk, Holland
49	6119	WRD	Sharon, Pa.
49	6119	NFM	Honolulu, T. H.
50	5996	2XAD	Schenectady, N. Y.
50	5996	SAJ	Karlsborg, Sweden
51.5	5822	WQN	Rocky Point, N. Y.
53	5357	NFG	Tutuila, Samoa
54	5552	NBA	Balboa, C. Z.
54.4	5511	NKF	Anacostia, D. C.
54.5	5501	WQN	Rocky Point, N. Y.
56	5354	KFKX	Hastings, Neb.
56	5354	ANF	Malabar, Java
56	5354	1XAO	Belfast, Me.
57	5260	WQN	Rocky Point, N. Y.
58.79	5100	KDKA	East Pittsburg, Pa.
59	5082	KDC	Casper, Wyo.
60	4997	2YT	Poldhu, England
63	4769	KDKA	East Pittsburg, Pa.
67	4475	8XS	East Pittsburg, Pa.
68	4409	NPO	Cavite, P. I.
68.4	4383	WRB	Miami, Fla.
68.4	4383	WRP	Miami, Fla.
70	4288	2XAO	Belfast, Me.
70	4288	POX	Nauen, Germany
70	4288	NPO	Cavite, P. I.
70 to	4288		
84.5	3548	NERM	USS Los Angeles
70.5	4253	NQG	San Diego, Calif.
71.8	4205	NKF	Anacostia, D. C.
71.7	4182	NPL	San Diego, Calif.
74	4052	WIR	New Brunswick, N. J.
75	3998	SFR	Paris, France
75	3998	NUQB	USS Pope
75	3998	NIRX	USS Canopus
76	3945	NAJ	Great Lakes, Ill.
77.4	3874	NFY	Quantico, Va.
79	3795	J1AA	Iwatsuki, Japan
80	3748	NEL	Lakehurst, N. J.
80	3748	2XK	Schenectady, N. Y.
81	3701	NPQ	San Francisco, Calif.
81.5	3679	NKF	Anacostia, D. C.
83	3612	EDW	Moscow
84	3569	NKF	Anacostia, D. C.
85	3527	PAR	Paris, France
86	3485	NQG	San Diego, Cal.
90	3381	KIO	Kahuku, T. H.
94	3190	2YT	Poldhu, England
95	3156	KEL	Boinas, Calif.
96	3122	8XS	East Pittsburg, Pa.
100	2998	POX	Nauen, Germany
100	2998	NAM	Norfolk, Va.
103	2911	WGH	Tuckerton, N. J.
105	2855	WHU	SS Big Bill
109	2751	2XK	Schenectady, N. Y.
112	2677	1XAO	Belfast, Maine
115	2607	FL	Paris, France
115.8	2600	KFVB	SS Bridget

Communications

The Publishers of QST assume no responsibility for statements made herein by correspondents

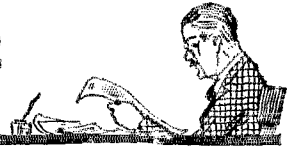

The Army Network

Office of Chief Signal Officer,
Washington, D. C.

Dear Mr. Maxim:

Former confirmation of the scheme for affiliation of the Signal Corps with the transmitting radio amateurs, as approved by the War Department, was transmitted to you on September 28, 1925.

The national officials of the American Radio Relay League are assisting largely in working out the plan and have willingly contributed their loyal efforts in putting the plan into effect. The great organization which they represent is preeminently the agency fitted to assist the Government in building this nation-wide emergency radio system.

I do, therefore, appoint the American Radio Relay League as representative of the transmitting radio amateurs of the country in their affiliation with the Signal Corps of the Army.

—C. McK. Saltzman, Major General,
Chief Signal Officer of the Army.

Poor Operating

672 6th Avenue,
San Francisco, Calif.

Editor, QST:

I have in the last few months reentered the amateur operating game and although I have been more or less active in amateur radio for the past many years. I do believe that as time goes on, with the betterment of apparatus and as the value of the lower waves is demonstrated, the fascination for the experimenter increases.

There is only one thing that seems to stand out before me like a sore thumb as I recall all the improvements in amateur radio, and that is the lack of improvement in the operating by the men themselves. By this time there should be a snap in the handling of messages and information that is not there. The methods of calling; the ways of handling a message; the all-round method of handling traffic has gone backward instead of forward.

For instance, I have a message for another station. I call the other fellow, he answers and says "r r GA QRK QRK?" etc. Then I must answer his QRK, say QRV and wait for his answer before I go ahead. Then after transmission of my

message is through, I must go through a seeming formality of 73's and Gld Wk U OM and a general hamming back and forth before my message, which should have taken ten minutes for transmission, is complete, and about twenty-five minutes of my time is required for this *one* message alone.

Amateur transmission is fast forging ahead but can't the fellows, through our medium QST, instill into the other fellow the beauty and satisfaction of snappy and modern transmission in the handling of messages?

May the coming year bring increased success to the A. R. R. L. and amateur radio.
—Sydney J. Fass

Good Break-In Dope

1022 South Ash Street,
Casper, Wyoming.

Editor, QST:

Noting the Traffic Manager's request for information on a successful break-in system, I am giving here a system that has been used commercially on a high power set using voltages up to 3,500 and powers over 2 K.W. A break-in system to be of any real value should give dead silence in the phones of the receiving set on any wavelength, whether it happens to be on your transmitting wave or not. We know that when we key in the primary of the plate transformer or in the negative lead of the high voltage generator we help to eliminate key thumps. These are the best points at which to key. When keying here, though, the tubes oscillate merrily on because the grid circuit is not opened. If we could break both the primary of the plate transformer and the grid circuit we would have an ideal keying system. This can be done comparatively easily.

A Leach relay must be used. This relay was described in the June 1924 issue of QST on page 33. One can be constructed from the directions given in this article, or it can be purchased either for amateur or commercial purposes ready-made. Referring to the diagram of the Leach relay shown herewith, contacts "A" close first and should be connected to the grid circuit. These contacts complete the grid circuit before the power is applied to the plate by closing the contacts "B". These latter contacts are closed a few thousandths of a second *after* contacts "A" are made. When

the key is opened the power is shut off first, as is the key thump, then the "A" contacts open the grid circuit and there is dead silence in the phones because both plate and grid circuits have no voltage. The relay will operate so rapidly that a bug can be cut in and adjusted for maximum speed and the relay will never miss a shot or fail to split the time the contacts close.

There is an auxiliary set of contacts at "C". These open just a trifle before the "A" and "B" contacts close. In the case of

work Europe in the evenings are the Porto Ricans, and there are mighty few of them! The Brazilians are very strong, and numerous too, but they never seem to be able to work Europe.

We are getting along with the Aussies and Zedders all right, but what has happened to the whole gang we used to hear every night? Even our big British gang has fizzled down to half a dozen or so. We did much better DX last summer. Have we gotta wait till next summer for the good old days?

—S. K. Lewer, 66LJ

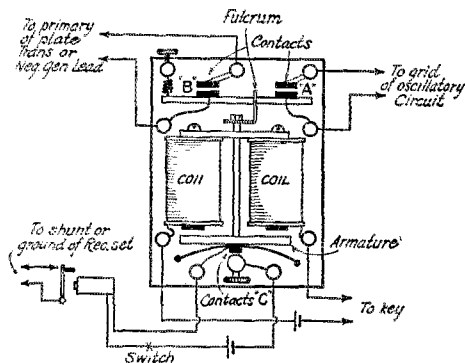

the high power transmitter and especially if the transmitter and receiver are close to each other, the receiver may pick up enough energy to burn out coils or condensers or make grid leaks noisy. By taking a fifty cent pony relay and reversing the contacts on the goose neck of the relay, the auxiliary contacts "C" on the Leach relay can be used to open and close the contacts on the pony relay. In turn the receiving set can be grounded or the secondary short-circuited by the pony relay contacts. The main relay keeps the pony relay drawn up when the former is open, so in order to prevent any unnecessary drain on the A battery operating the relays, a switch X should be put in series with the battery. This switch is opened if you are listening for any length of time.

A relay break-in system of this type has been in use here for over a year and never has failed to operate properly.

—Norman R. Hood

Back to 80 Meters?

32 Gascony Avenue,
West Hampstead,
London, N. W. 6, England.

Editor, QST:

What on earth has happened to 40 meter DX? Now it's nearly impossible to work you American fellows around midnight G.M.T. We can hear about a half dozen U's with pretty good signals, but we get the same lot of fellows every night. Have all the others gone back to 80 meters? The only fellows who seem to be able to

A Warning!

Philip Werlein, Ltd.,
New Orleans, Louisiana.

Editor, QST:

Recently a vacuum tube salesman in trying to sell me a new line of vacuum tubes, brought out the fact that his tube was endorsed by QST. I asked him for verification and he showed me a photostatic copy of a letter from a prominent Brooklyn amateur. In this letter the writer did endorse the new tube, and inasmuch as it was written on QST membership stationery, the Company had assumed that this gentleman was connected with QST, and the salesman is using this letter as an endorsement by QST. I do not know whether this is common practice or not, but I am certainly opposed to members using membership stationery in this way, and for that reason I am taking this up with you. I think that the tube Company is perfectly honest in its belief that they have an endorsement by QST.

—B. H. Woodruff

(Editor's Note—We are glad that Mr. Woodruff has called this matter to our attention. Endorsements of radio apparatus of any kind when written on membership stationery of the A.R.R.L. and QST are only expressions of personal opinion on the part of the member of the League and do not in any manner imply that either the A.R.R.L. or QST officially approve of the device. If and when the A.R.R.L. or QST Headquarters approves apparatus in this manner, the letter of approval will appear on stationery bearing the caption "Executive Headquarters, Hartford, Conn." at the top of the page, and said endorsement will be signed by some official of the League, or someone on the staff of QST. Members are particularly cautioned to so word their endorsements that it will be self-evident that said endorsement is an expression of opinion solely on the part of said member alone.)

Low Power Dope

436 Delaware Avenue,
Toledo, Ohio.

Editor, *QST*:

Since you published the "Stray" in the January issue of *QST* about my signals being heard in South America on a 201-A tube transmitter fed by two audio frequency transformers I have been swamped with letters and cards asking how the set was hooked up. So I think a little dope would help some struggling ham.

The whole power unit outside of the condensers and chokes cost me eight dollars. The amplifying transformers came from Kresge (or Woolworths) and cost a dollar each. The two bell ringing transformers

little comment in *QST* lately. I have been operating on the Great Lakes for three years and have encountered this form of the pest innumerable times. It usually occurs in unsettled weather just preceding or following a thundred-squall or snow storm. The following are my observations of a manifestation which occurred a few days ago in Lake Superior:

The static of the blasting type was extremely heavy; in fact it was impossible to work a distance of more than a few miles. Occasionally an extra heavy discharge would jump across the safety gap on the primary of the receiver. Many lightning flashes were visible at this time and the thunder was rolling out occasionally. Gradually this blasting static ceased, and the atmospheric conditions were fair for radio communication as the squall passed on. The rain then settled in in a steady drizzle. This was closely followed by a faint hissing sound resembling the sound produced by someone a good distance away holding down the key of a spark transmitter while the receiver is in an oscillating condition. This gradually increased in intensity until it became a continuous roar and began to break down in a series of discharges across the safety gap, at regular intervals. When the phenomena was at its peak I threw the lightning switch to the "ground" side and noticed that it sparkled heavily. I tried placing the switch blade equi-distant between the receiving and ground connections, in which position a violent brush discharge was noticed extending

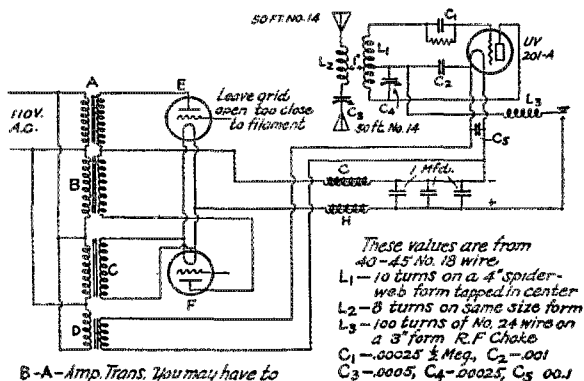

B-A-Amp. Trans. You may have to change them till you get the polarity correct. (6-1 ratio)

C-D-Bell ringing Trans. About 10 v.

E-F-Dollar tubes, type 201-A, leave grid disconnected.

C-H-Telephone induction coils

FILTER CONDENSERS - 3-1 mfd. good paper condensers

are used to light the tube filaments. The rectifying tubes are the Kresge Wonders costing a dollar per each. The chokes are telephone repeater coils (Secondaries of old audio transformers could be used here.—Asst. Tech. Ed.) and the filter condensers are 1 mfd. paper affairs.

The circuit is shown in the diagram. I have held the key down steadily for five minutes and the transformers just barely get warm. They turn out about three hundred volts D.C. after it has been rectified and filtered. This makes a 201-A oscillator settle down to work.

—R. C. Spense, 8AJX

More QRN Storms

Steamer Philip D. Block,
Marine Post Office,
Sault Ste. Marie, Mich.

Editor, *QST*:

A few additional observations on static of the hissing type which has caused no

from three to four inches out from any projecting points from the antenna lead-in or switch.

To illustrate the potency of this charge, the lightning switch in the set has two ten inch cords attached to the blade so that the switch can be "remote controlled". These dry cords became so heavily charged that they were deflected three or four inches if the hand of the operator was brought nearer than an inch or two. A small brush formed between the operator's hand and the wooden handles of these cords. At this writing, this particular form of static is manifesting itself as a very slight hiss and an occasional discharge across the safety gap, while the blasting type is not noticeable at all.

This type of static is encountered often on northern Lake Huron and Lake Superior. It is rarely met in the southern portions of the lakes. I have noticed this form of QRN on perfectly clear, cool fall days when previous conditions had been ideal for DX reception. Frequently the hiss is not strong

enough to interfere with communication unless it begins to jump the discharge gap. This seems to occur mainly on the 600 and 706 meter waves. I have often listened below the 600 meter wave and have never noticed it down there.

You may be interested in knowing that I recently listened in during a wonderful display of the Aurora Borealis and noticed absolutely no effect upon radio communication. In fact it was an ideal time for reception.

—John B. Eccles, opr. WKC ex3CSK.

Standard Calling Method

1311 Spring Road,
Washington D. C.

Editor, *QST*:

It would be useful if the listener could know how much longer the station to be answered would call, so that the receiver could be left alone, or the tuning improved before he signed. In general it is desirable for one station to know as much of the intentions of the other fellow as possible. If calls are made as follows, matters may be facilitated:

— — — — cq cq cq u 3CAB 3CAB 3CAB
cq cq u 3CAB 3CAB
cq u 3CAB

A long call could be made by making the first one four repetitions. Once established this would break up the habit of sending automatically as many as 50 cq's before the operator comes out of his trance. How about it, fellows?

—C. A. Briggs, 3CAD.

These Here Antenna Masts

Osage, Iowa.

Dear Eddie:

Seeing from time to time masts described in *QST*, and how to make them, I thought I would tell you of a *good* mast. There are lattice type masts, gutter pipe masts and a thousand and one other types but the Iowa corn mast is the latest. It's a beaner, too. Like all other masts this one presents some difficulties in erection, but as I will give my troubles others will profit by them and be able to get a coupla good masts without much trouble.

To begin with I needed two masts. I wanted them in a hurry, and like most hams I didn't have a fat pocketbook. I went to the corn crib and selected two kernels of corn, having previously figured out the length of the finished masts I wanted. I might say here that the length of the mast divided by the length of the aerial, and the answer pointed off three places left of the second zero point will give you the length of the kernels of corn. I then planted the corn at the proper distance so that the masts would come up far enough apart, and waited for the stalks to show up on top of the ground.

Here nature stepped in and did her bit. It all happened this way: the next morning when I got up the masts had done likewise. I heard a peculiar hissing noise which, upon investigation, proved to be the cornstalks growing. It seems that the sun shining on the corn started it to growing that very

morning at sunrise. By this time the masts were only ten feet off the ground so I got an extension ladder to attach the pulley and rope to the top of the masts. When I got the ladder up in the air the sun happened to go behind a cloud and the mast growth slowed down a bit. By the time I got to the top of the ladder the stalk was only thirty feet high. I finally succeeded in getting the pulley stuck to the top of the mast and started to climb down. The sun came out again and I immediately felt the stalk start to grow. A leaf from the stalk caught in one of the rungs of the ladder and the stalk grew faster than I could crawl down. Instead of coming down to earth I was really getting up higher and higher in the air. I was able to get to the bottom of the ladder but found that I was sixty feet off the ground. By sliding down the stalk as quickly as I could I managed to get within forty feet of the ground when the sun went behind a cloud again. The inertia carried me on and on and I hit the ground with a thud.

I did not want an antenna a hundred and fifty feet high so I grabbed an axe and started to chopping the stalk off. But the stalk grew faster than I could swing the axe—I never hit in the same place twice. So I tried dynamite. I put about fifty sticks under the roots of the stalk and set off the charge. This blew the stalk out of the ground but it kept on growing, even while it was falling to the earth. The stalk finally ceased to grow after it had been out of the ground for a half an hour. I measured the stalk when it quit growing and it lacked two feet of being a mile long.

I am now working on the problem of controlling the growth of corn stalks of the Iowa type so that I can enter the business of "masts while you wait."

—9AIQ, *The Corn King*.

IT IS READY

The Wimco Type B Wavemeter is now in production. Built to meet a popular price demand without sacrificing accuracy. Made in ranges from 15 to 200 meters.

Send for literature

The Wireless Mfg. Co.

Canton,

Ohio

RADIO SCHOOL

Send for Catalogue

**MASSACHUSETTS RADIO
and TELEGRAPH SCHOOL**

NEW TERM MARCH 1

18 Boylston St.

Boston, Mass.

THE SIXTH ANNUAL
SECOND DISTRICT
Amateur Convention
and
Radio Exhibit

MARCH 8-13
1926



Pennsylvania
Hotel-New York

“The Best Ever”

Technical talks, club exhibits and your choice of nine different contests. Send for details and entry blanks.

Make your reservations NOW for the “ERCÓ” Initiation and Banquet.

Under the Auspices of

The Member Radio Clubs

Comprising the

Executive Radio Council, 2nd District

74 Cortlandt Street, New York

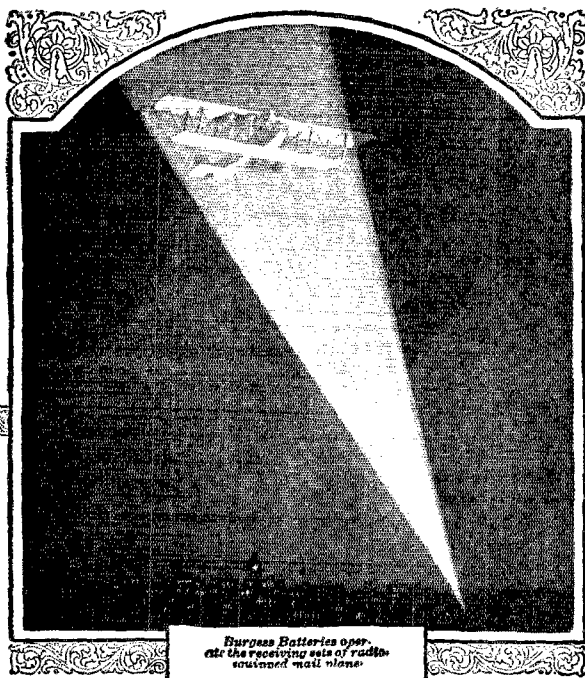

An every-night adventure of Burgess Radio Batteries

ONE of the reasons why you should always buy Burgess Radio Batteries is that the batteries used by air-mail pilots—battleships—explorers and the majority of recognized radio engineers—are evolved in the Burgess Laboratories and manufactured in the Burgess factory.

These batteries are identical with the batteries sold by your dealer and thousands of other good dealers everywhere.

Ask Any Radio Engineer

BURGESS BATTERY COMPANY

GENERAL SALES OFFICE: CHICAGO

Canadian Factories and Offices: Niagara Falls and Winnipeg

BURGESS RADIO BATTERIES

GENERAL INSTRU



have a
Laboratory
of OVER A

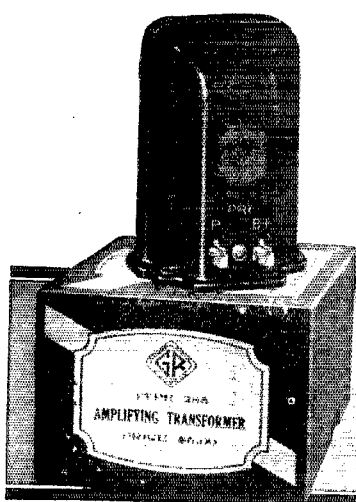

THE science of radio has reached its present day development only by careful study of fundamental principles. Much of this study has been conducted with scientific apparatus made by the General Radio Company and used in the laboratories of such prominent institutions as the General Electric Company, Westinghouse, Bell Telephone System, and Bureau of Standards.

No one company in the history of radio has contributed more in laboratory equipment than the General Radio Company. To-day General Radio precision instruments are standard equipment in nearly all the commercial and technical school laboratories throughout the world.



Behind the Panels

RADIO MENTS



Background DECADE

The same outstanding craftsmanship and materials are embodied in General Radio parts for use in the construction of broadcast receivers.

Through the merits of design, performance, and price General Radio instruments for the scientist or set-builder are universally recognized as the Standards of Excellence.

Every instrument made by the General Radio Company is thoroughly guaranteed.

GENERAL RADIO CO., Cambridge 39, Mass.

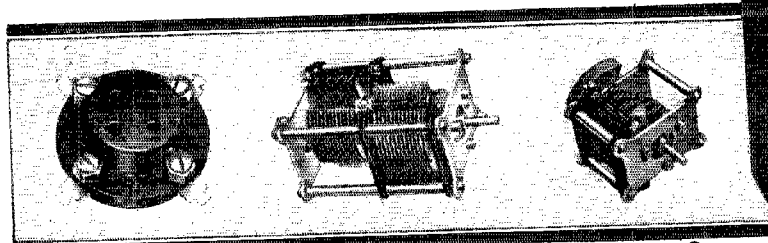
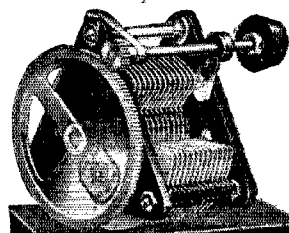

of Better Built Sets

SAY YOU SAW IT IN QST—IT IDENTIFIES YOU AND HELPS QST

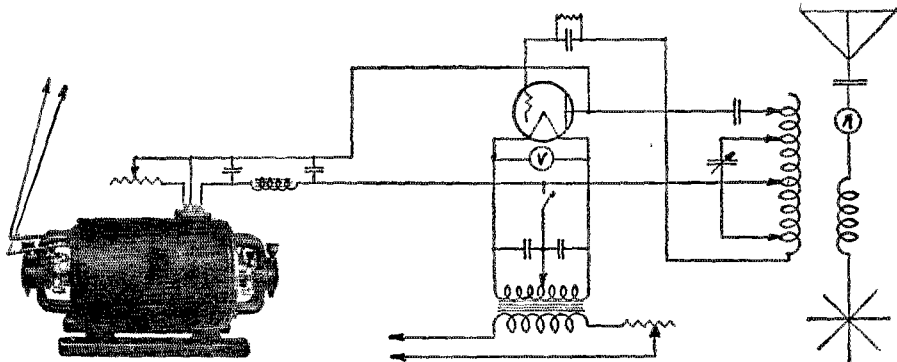

Item 11A, Type MG-343S output 1000 volts, 300 watts, an efficient and compact Power Supply for one or two 50 watters. This machine is built ruggedly yet designed to take a minimum of space. It is a machine that not only will stand the kicks of hard usage but will also give your Station a kick that will turn the Q. R. Z.'s into Q. S. A.'s.

ELECTRIC SPECIALTY COMPANY

Manufacturers of Motors, Generators, Motor-Generator Sets, Dynamotors and Rotary Convertors for all radio purposes. Have you got your copy of Bulletin 237B and ESCO Filter facts? If not write for them.

TRADE 'ESCO' MARK

225 South Street

Stamford, Conn., U. S. A.

There is no question about the Miles per Watt with ESCO—it is the maximum.

MORE PROFITS

for the Professional SET BUILDER

We have an unusually interesting proposition to make to the man who is now building* (or has the ability to build) radio receiving sets for resale.

This is a real opportunity. Write today for full information.

Gearhart-Schlueter Radio Corp.

718 Voorman Avenue

Fresno

California

Another TOAZ Development FUSOCKETS

PATENT APP. FOR

Individually Fused Sockets
Insure your Tubes
199 or 200

Single or any multiple

At Your Dealers or

\$1.00 per Socket, P. P.

TOAZ TERMINALUGS BEST FOR RADIO BUGS

At your Dealers or send \$1.00 for Special Package, including Gripfast Terminalugs. (Pat. App. For.)

TOAZ Engineering & Sales Co.
11703 ROBERTSON AVE., CLEVELAND, O.

Use the Condenser that's made for the job

The Filter Condenser

For "B" battery eliminators

Specially designed for the high voltages developed in the filter circuits of "B" battery eliminators, a permanent life when operated continuously at voltages up to their maximum working ratings.

Use this condenser in building any type of battery eliminator. Dubilier Filter Condensers are specified for the "B" battery eliminator described on Page 31, February QST.

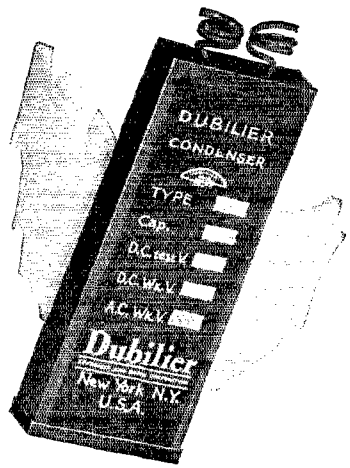

The By-Pass Condenser

For use across "B" batteries

To shunt radio frequency currents around the high internal resistances of "B" batteries, to insure an even flow of battery current, and cut down battery noises—use a By-Pass Condenser across your "B" battery.

Don't use By-Pass Condensers in the filter circuits of "B" battery eliminators—use the Filter Condenser especially designed for that work.

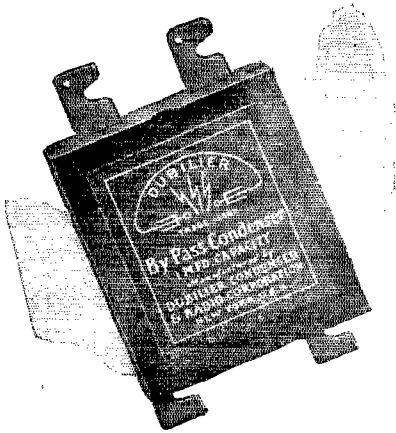

Dubilier

CONDENSER AND RADIO CORPORATION

The NEW WESTON Pin-Jack Voltmeter

NO tools, no trouble, no adjustments—just plug this handy Voltmeter into the Pin-Jacks provided for it on the new models of Radiola, Victor and Brunswick sets. Simply turn your battery setting knob until the pointer of the Model 506 touches the red mark at 3 volts on the instrument dial. You are then operating at the critical tube voltage and will get the best results from the set.

Tests show that 90% of your troubles will vanish through the use of this instrument.

This is a new member of the famous line of Weston Quality Radio Instruments which contribute to your pleasure and save you money through efficient operation.

Ask your dealer to show you this new instrument or write us for full information.

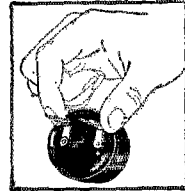
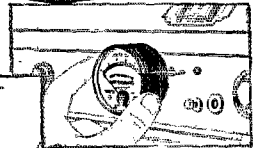
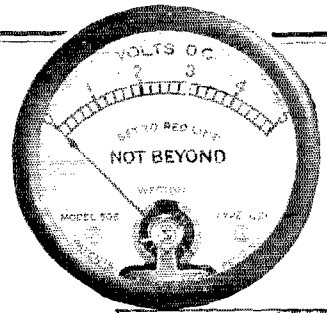

WESTON ELECTRICAL INSTRUMENT Corp.
158 Weston Avenue, Newark, N. J.

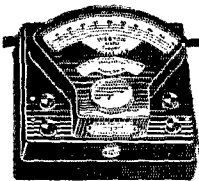

STANDARD THE WORLD OVER
WESTON
Pioneers since 1888

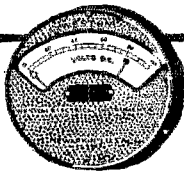

The New

CARTER "IMP" Loop Aerial

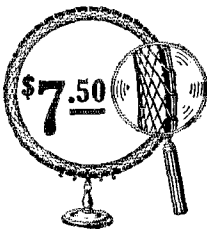

The most efficient loop made. Diameter 18". Maroon enameled wire. Can be used with any circuit designed for loop reception.

Compact, weighs but one pound. Pure inductance: 155 microhenries. Distributed capacity: .000464 microfarads.

Average resistance (Bureau of Standards method): 7.0 ohms.

Fundamental wavelength: 160 meters. Wavelength range (with .0005 mfd. condenser): 180 to 560 meters. Absolute minimum losses due to practically no material in field.

See one at your dealers

In Canada: Carter Radio Co. Limited—Toronto

Q.M.A.

Carter Radio Co.
300 S. MICHIGAN AVENUE
CHICAGO, ILL. U.S.A.

RAJAH SOLDERLESS SNAP TERMINALS

Instantaneous in Operation—Positive Contact. For Panel, Ground and Battery Connections.

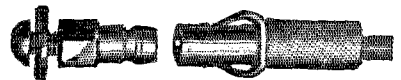

Patented—Sept. 23rd, 1924.

The Base Stud is tapped and furnished with 8-32 screw and washer. This fits all "B" Batteries with screw posts.

RAJAH
Ground
Connection

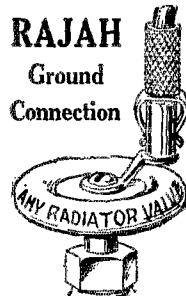

Used on
TUNGAR,
RECTIGON,
PHILCO and
EXIDE.

Terminal, complete, either style15c

Extra Base Studs5c

RAJAH AUTO SUPPLY COMPANY
Bloomfield, New Jersey

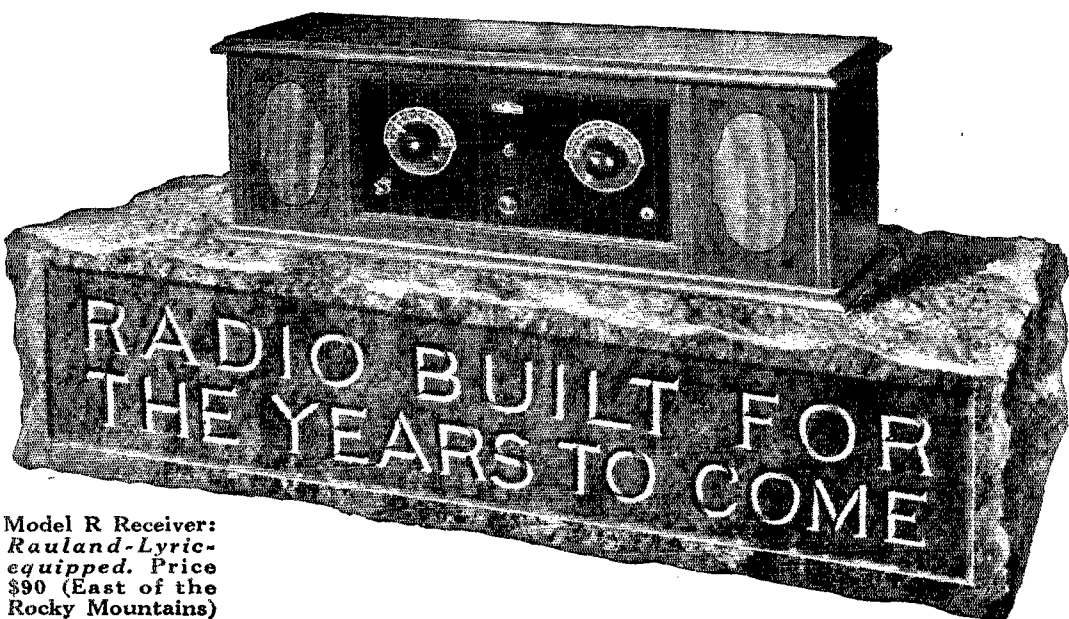

Model R Receiver:
Rauland-Lyric-
equipped. Price
\$90 (East of the
Rocky Mountains)

Beauty and Permanence

Listeners Marvel—

at the wealth of enjoyment awaiting but a touch of the fingers.

Women Are Delighted—

with the tasteful stateliness of the Model R cabinet, as much as with the neatness of its battery accommodations.

Engineers Voice Approval—

of the rigid spot-welded steel chassis, protecting from damage every part of a set that stands as a notable example of the *completely manufactured* rather than the merely *assembled* radio receiver.

Service Men Commend—

the thoroughness with which every part has been made proof against the interruption of its service, so far as human ingenuity can devise.

Dealers Are Enthusiastic—

over the excitement created everywhere by this unique receiver and the uniform satisfaction felt by its users.

Buy "Solid Value" in Your Radio

The leading wholesaler of radio apparatus in your community has probably been, for years, an ALL-AMERICAN Authorized Distributor. ALL-AMERICAN Guaranteed Radio Products are being shown everywhere by responsible and reliable dealers.

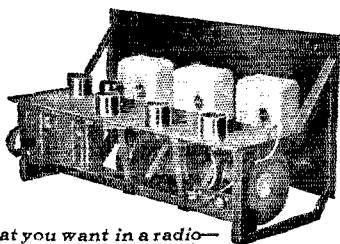
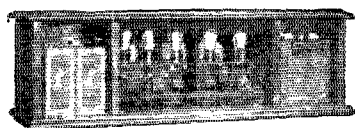

All that you want in a radio—
natural tone, sharp selectivity,
straight-line-frequency tuning
(360°) unaffected by position
of the fingers, extreme
sensitiveness, permanence.

ALL-AMERICAN RADIO CORPORATION, E. N. Rauland, Pres., 4205 Belmont Ave., Chicago, U. S. A.

MEMBER
RMA

OWNING AND OPERATING STATION WENR—266 METERS

ALL-AMERICAN

Pioneers in the Radio Industry

MYERS TUBES

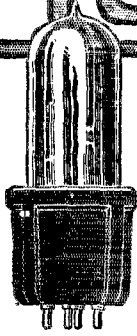

Get Out of the Fog

Myers Tubes make an instantaneous improvement in the clarity, volume, distance and quality of reception from any Radio Set.

The Tube is the Voice of the Circuit

MYERS Tubes are real Radio Tubes—not modified incandescent lamps. They are made by pioneer Radio Tube designers, for Radio purposes exclusively. Compact, precisely correct, free from dead spaces and clumsy dimensions. Finest performance, finest appearance.

Special internal geometry gives highest mutual conductance and largest factor of amplification, resulting in maximum performance when used in either transformer, impedance or resistance coupled circuits.

Unbreakable in normal use. Double-end electrode supports. Absolutely non-microphonic. Perfectly uniform. No matching necessary.

Marvelous Clarity

Internationally preferred by amateurs and experts. Made with standard four prong base, or double-end, in types Myers 01A, Myers 01X, Myers 99, Myers 99X.

List price, any type \$2.50.

Fully protected by patents pending and issued in the United States and Foreign Countries.

At Your Dealers

Myers Radio Tube Corporation
Cleveland, Ohio



Mechanically
and Technically
Correct.

S-M PARTS

LOW LOSS INDUCTANCES

All-bakelite, low loss, interchangeable coil for 50-500 meters. May be used as oscillators, antenna adapters and RF Transformers in standard circuits. Each 3 1/2" long with winding diameter of 2".

Price all types, 50 to 600 meters. Each.....\$2.50.
Sockets for any size coils. Each.....\$1.00

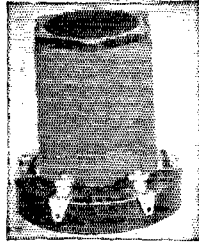

NEW LONG WAVE COILS

SM Interchangeable inductances are now available for European wavelengths. These coils are merely plugged in, in place of present sizes. No circuit changes necessary. Regular Type numbers apply.

FOR THE SILVER "SIX"

550—1200 Meters	1200—1800 Meters
2—112 D Coils	2—112 E Coils
1—110 D Coil	1—110 E Coil

FOR THE SILVER SUPER

550—1200 Meters	1200—1800 Meters
1—110 D Coil	1—110 E Coil
1—111 D Coil	1—111 E Coil

PRICE ANY TYPE NUMBER

D Range.....\$3.25	E Range.....\$3.50
--------------------	--------------------

Improved Raytheon-Thordarson B-eliminator SM Kit 650 includes all parts necessary, \$34. Building Instructions, 10c.

Send for circulars describing S-M Products

SILVER-MARSHALL, Inc.
104 WABASH AVE. CHICAGO

"The Better Condensers"



or not

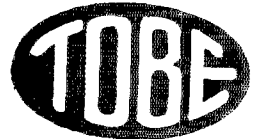

that is *not* the question."

There is no question as to the quality, accuracy and reasonableness in price of the TOBE Condenser.

Made in all voltage ranges from 2,000 volts down to 200 volts. For high-voltage filter work, for by-passing, for coupling condensers in impedance and resistance-coupled amplifiers—from .1 Mfd. to 4 Mfd.

The need of adequate condensers in Battery Substitutes is clearly brought out by Robert S. Kruse in his article on that subject in Q & T for February, 1926.

Send for complete descriptive circulars. These circulars give full particulars of filter circuits and plate-supply units for various uses.

Tobe Deutschmann Co.

Cornhill, Boston, Mass.

QST QST QST ---CARDWELL---

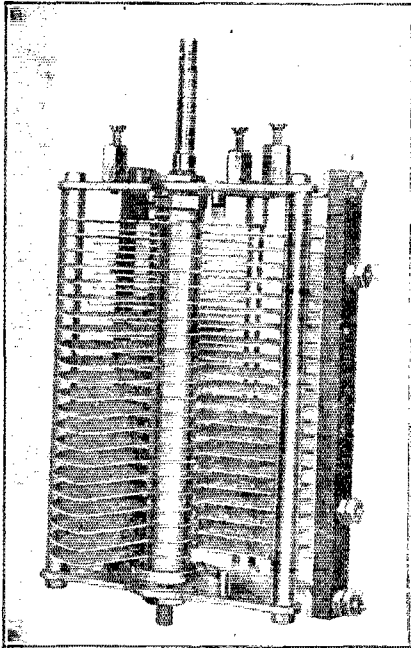

THE MOST DISCRIMINATING BUYER of radio material is the amateur. Nothing but the best will be tolerated . . . to be used it must be right.

CARDWELL CONDENSERS ARE probably used more extensively in amateur transmitters than all other makes combined

IN ORDER TO BRING THESE condensers within the reach of many who heretofore could not afford them, Cardwell decided to eliminate the jobber and dealer on all transmitting condensers, and sell direct to the user at the lower prices thus made possible.

Any of these condensers can be used across grids or plates of two 50 watters. For the quarter KW, use Type 182-B or 183-B. For two 500 watt tubes—the 166-B.

— THE NEW LOWER PRICES —

Number Type	List Price	Number Plates	Capacity Minimum MMF.	Capacity Maximum MMF.	Plate Spacing Inches	Breakdown Voltage	Overall Length Inches
164-B	\$7.00	21	13	217	.070	3,000	4.000
147-B	10.00	43	35	440	.070	3,000	5.875
157-B	12.00	21(*)	16(*)	217(*)	.070	3,000	5.875
182-B	14.00	23	23	127	.153	5,500	5.875
183-B	16.00	31	33	156	.153	5,250	7.500
166-B	70.00	23	38	297	.219	7,600	9.125

* Double stator of 21 plates each.

Edgewise wound copper strip, section 1-4" x 1-16"—wound to
 5 1-4" in diameter . . . 10c per turn
 9 1-2" in diameter . . . 15c per turn

ORDER DIRECT FROM US. GIVE YOUR CALL LETTERS.

CARDWELL

81 Prospect Street

Brooklyn, N. Y.

"THE STANDARD OF COMPARISON"



Known the World over for its simplicity of operation. Correct electrically and mechanically. Made by the house which has been known as headquarters for transmitting apparatus for over forty years.

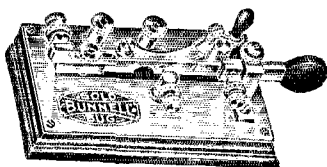

Price with wedge and cord **\$12.50**

Plush lined carrying case with lock and key **\$ 3.50**

BUNNELL DOUBLE SPEED WIRELESS KEY

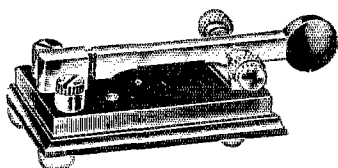

Designed for wireless use. For speed in transmitting it has no equal. Requires but half the motion of the ordinary key. Operated by rocking motion absolutely prevents cramp.

Price **\$9.50**

J. H. BUNNELL & CO.

32 Park Place

NEW YORK, N. Y.

FOUNDED 1879—MANUFACTURERS OF TELEGRAPH APPARATUS FOR OVER FORTY YEARS

The Real Possibilities

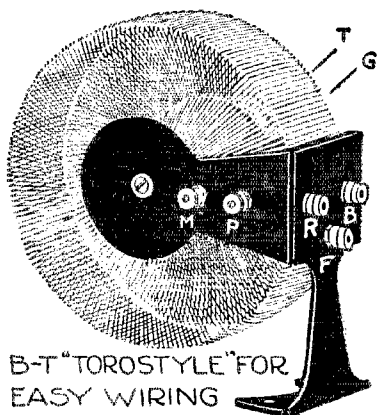

B-T "TOROSTYLE" FOR EASY WIRING

Of "toroid" construction and balanced design will be appreciated when you use B-T Torostyles in the B-T Counterphase, -- both patented, and each designed for the other.

1, 2, and 3, R.F. Stage hook-ups in 9th edition of "Better Tuning" sent postpaid 10c. Circular free.

BREMER-TULLY MFG. CO.
532 So. Canal St. - - - Chicago

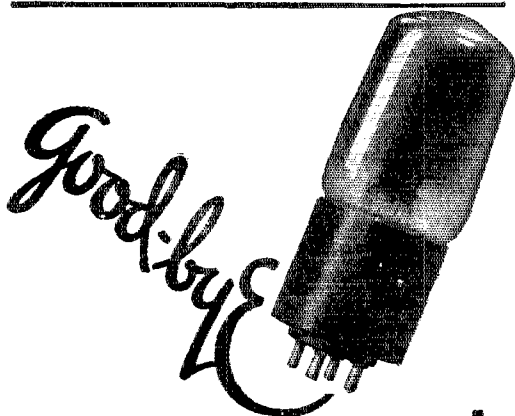

TUBE TROUBLES!

Fifteen years of radio research is behind this new Magnavox wonder tube. Internal capacity only 4.5 MMF—oscillates freely on low wave lengths without unbasing. Amplification constant very high with low impedance. Price, \$3.

THE MAGNAVOX CO., Oakland, California

NEW MAGNAVOX
Non-Microphonic • Tube • Tipless

The Newest Achievements of POWEL CROSLEY JR.

Industrialist, Pioneer Radio Builder, Master of Mass Production

*Four entirely new radio
sets employing 4 and 5 tubes*

- entirely new in principle, design, circuit and appearance.
- entirely unique in the results they give on distant and local stations.
- entirely original in their standards of beauty.
- entirely unprecedented in the value they introduce.
- two of them incorporating the Crescendon, a new and exclusive volume control.

Now being demonstrated by Crosley dealers everywhere.

THE CROSLEY RADIO CORPORATION, CINCINNATI, OHIO

Owning and Operating WLW first remote control super-power broadcasting station in America

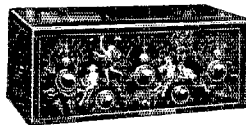
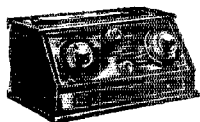

The Crosley 4-tube
4-29

In which the Crescendon is equivalent to one or more additional tubes of tuned radio frequency amplification \$29

The Crosley 5-tube
5-38

All the volume, selectivity, sensitivity and purity of tone available in the best 5-tube set—plus the Crescendon \$38

The Crosley 5-tube—RFL-60

A set so marvelous in performance that its appearance on the market is bound to create a new standard of comparison.. \$60

The Crosley 5-tube—RFL-75

For simplicity and speed in tuning, fidelity of tone, and decorative beauty—it stands unchallenged at twice the price..... \$75

West of the Rocky Mountains all prices as published are 10% higher

CROSLEY RADIO

BETTER · COSTS LESS

IF YOU SAW IT IN QST—IT IDENTIFIES YOU AND HELPS QST

SANGAMO

Mica Condensers in intermediate sizes



IMPROVE
TONE
RANGE
AND
VOLUME

It is accuracy, not luck, that makes one receiver sweeter and more powerful than another that is almost its twin. Especially condenser accuracy, for the closer you come to absolute accuracy at these critical parts, the more wonderful your receiver will be. The cost of accurate condensers is small—the effect is immense.

Now you can get Sangamo Mica Condensers in capacities in between the usual stock sizes so you can build with greater accuracy than ever before. They are guaranteed to be accurate, and they always stay accurate, being solidly molded in bakelite. Neither heat, cold, moisture, pressure nor acid fumes will affect their capacity, because bakelite seals the delicate parts against all outside influences.

Capacities in microfarads and prices

0.00004	} 40c.	0.001	} 50c.	
0.00005		0.0012		
0.00006		0.0015		
0.00007		0.00175		
0.00008		0.002		
0.0001		0.0025		
0.00012		0.003		} 60c.
0.00015		0.0035		
0.000175		0.004		
0.0002		0.005		70c.
0.00025	0.006	85c.		
0.0003	0.007	90c.		
0.00035	0.0075	95c.		
0.0004	0.008	\$1.00		
0.0005	0.01	1.15		
0.0006	0.012	1.20		
0.0007	0.015	1.25		
0.0008				

With Resistor clips, 10c. extra

Also Sangamo By-Pass Condensers

1/10 mfd.	80c.	1/2 mfd.	90c.
1/4 mfd.	80c.	1 mfd.	\$1.25

Sangamo Electric Company
Springfield, Illinois

RADIO DIVISION, 50 Church Street, New York

SALES OFFICES—PRINCIPAL CITIES

For Canada—Sangamo Electric Co. of Canada, Ltd., Toronto.
For Europe—British Sangamo Co., Ponders End, Middlesex, Eng.
For Far East—Ashida Engineering Co., Osaka, Japan

For
real
distance!

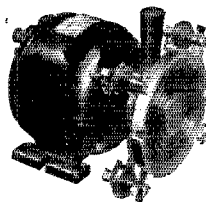

For
mellower
tone!

ADVANCE "SYNC" RECTIFIER

More in Use Than Any Other
Rectifier Made

Would you like to improve your transmission? The new improved Advance "Sync" Rectifier will enable you to reach those distant unknown ears you have been trying to reach. Gives clearer tone and better volume. Rectifies alternating current at 500 to 3000 volts to direct current for the plates of your transmitting tubes. Puts more energy into the antenna and counterpoise on account of actual copper-to-copper contact in rectification. Very efficient on short waves. Requires no attention—always ready. Thousands used in American Radio Relay League.

Revolving disk is moulded bakelite six inches in diameter. Nickel plated brush holders with adjustable gauze copper brushes. Convenient control handle. Disk, aluminum brush support and brush holders perfectly insulated.

For rectifying wheel with complete brush assembly and mounting ring to fit your own synchronous motor. (Note: Motor must be $\frac{1}{2}$ H. P., with $\frac{1}{2}$ in. shaft and 1800 R. P. M.)

Rectifier with Westinghouse $\frac{1}{4}$ h. p. Synchronous Motor—\$40.

We Pay All Transportation Charges in U. S. A.

ADVANCE ELECTRIC COMPANY

1260-1262 West Second St., Los Angeles, Calif.

SHORT-WAVE RECEIVERS

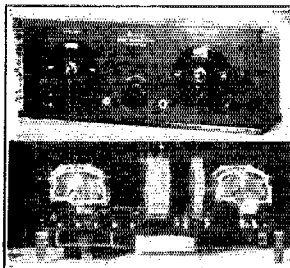

Built for efficiency on the short waves.

Low loss throughout. No backlash Dials. Tunes from 10 to 110 meters. Gen. Rdo. Transformer and UX sockets. In solid mahogany cabinet.

Special Price
\$38.50

NO LOSS INDUCTANCES

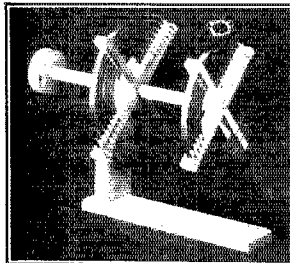

Wound with heavy brass on KILN DRIED Maplewood (which QST says, one of best insulators for short waves.) Variable coupling.

20-40 meter Sizes
\$5.45
30 meter
\$5.95

SPECIALS THIS MONTH
Acme mounted modulation transformer ... \$2.50
Cardwell Condensers, (rebuild) double spaced, .00025—\$3.95

R. C. A. UX 210 7 1/2 Watt \$7.50

"EVERYTHING FOR THE AMATEUR"

Send for list. All prices F.O.B. New York.

AMATEUR RADIO SPECIALTY CO.

17 Cortlandt Street, New York City

The New NATIONAL Variable Velvet Vernier Dial

*Positive
Control*

*Easily
Mounted*

Gearless

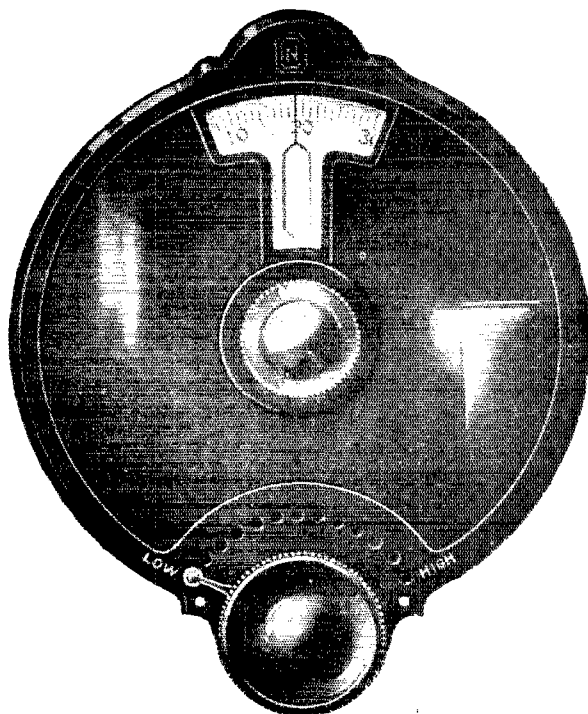

Variable Ratio

*Velvet
Smoothness*

Ornamental

TYPE B Patents Pending

THIS dial embodies a modified application of our "Velvet Vernier" mechanism designed to facilitate mounting on the $\frac{1}{4}$ " shaft of any standard type of variable condenser, without the use of tools other than a screw-driver. It will replace plain dials on any receiver where sharper tuning is desired.

Of special importance is a new and novel device which enables the user to adjust at will the **reduction to any ratio from 6-1 to 20-1**. This feature aids greatly in the separation of stations operating on the lower wave lengths. This new dial is moulded from black bakelite in a highly ornamental design with perfectly uniform graduations.

Specifications
Clockwise 0-200 (360°)
Counter-Clockwise (360°)

Nickle Finish
\$2.50
2.50

Gold Finish
\$3.00
3.00

NATIONAL COMPANY, Inc.

W. A. READY, *President*

110 Brookline Street

Cambridge, Mass.

A PIONEER

Small Size Precision Meter

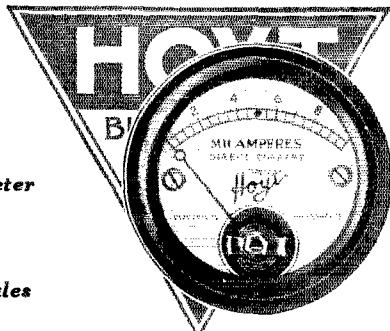

Hoyt Type 17
2" Moving-Coil Milliammeter
Ranges 0-15
0-25
0-50
Hand Calibrated Scales

Price, Black Rim
\$7.00

The HOYT Type 17 meter was the first 2-inch D'Arsonval Type Moving-Coil Meter developed for flush or panel-mounting use in Radio. In spite of its small size, it is accurate, yet extremely rugged. The shape of the pivots and jewels are worked out so as to strike the most effective balance possible between extreme sensitiveness, which is usually accompanied by extreme delicacy and liability to breakage, and ability to withstand rough handling. Voltmeters have a resistance of about 70 ohms per volt. All Hoyt moving-coil meters have hand calibrated scales.

HOYT Meters for your Radio are accurate, durable and reasonable in price. Send for booklet—"Hoyt Meters for Radio."

BURTON-ROGERS COMPANY

26 Brighton Ave., Boston, Mass. - - National Distributors

Faradon

NOW
Faradon Excellence for Your
Receiving Set Also

Faradon

MODEL T All-Metal-Mica Condensers



Usual capacities. Convenient terminals. Exceptional appearance. **QUALITY AT LOW COST.** Insist upon getting the MODEL T when you buy. Should your dealer not have them on hand write us direct. A descriptive folder will be forwarded if you mention QST.

"Fit out with Faradon"

Wireless Specialty Apparatus Co.
JAMAICA PLAIN, BOSTON, MASS., U. S. A.
ELECTROSTATIC CONDENSERS FOR ALL PURPOSES

SEE
THAT
SCREW

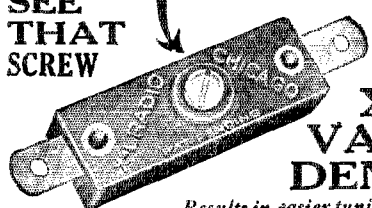

A screw-driver
adjusts an X-L
in crowded
places.

X-L VARIO DENSER

Results in easier tuning, more distance, volume and clarity—greater stability Indorsed by leading radio authorities.

Model "N"
A slight turn obtains correct tube oscillation on all tuned radio frequency circuits. Neutrodyne, Rohora two tube, Browning-Drake, McMurdo Silver's Knockout, etc., capacity range 1.8 to 20 micro-micro farads. Price **\$1.00**

Model "G"
with grid clips obtains the proper grid capacity on Cokaday circuits, filter and intermediate frequency tuning in heterodyne and positive grid bias in all sets. Capacity range .00016 to .00055 and .0003 to .001 micro farads. Price \$1.50

X-L Push Post
Push it down with your thumb, insert wire, remove pressure and wire is firmly held. Releases instantly. Price 15c.



X-L RADIO LABORATORIES
2428 Lincoln Avenue N. Chicago, Ill.

FAMOUS "BH" TRANSFORMERS

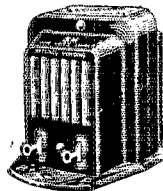

BH Vivaphonic (Registered)
A Straight-Line-Frequency Distortionless Transformer. Test curve made at McGill University shown in catalog. A full line of Transmitting Transformers. Ask your dealer for our literature or write us.

BENJAMIN HUGHES ELECTRIC CO.
298 LaGauchetiere St., W. Montreal, Canada
Transformer Builders Since 1910

A Precision Instrument For Precision Tuning!

THE PACENT TRUE STRAIGHT LINE FREQUENCY CONDENSER was developed by Pacent Engineers (pioneers in the design and manufacture of parts to perfect radio reception) to meet the widespread demand for a precision condenser to take the guesswork out of tuning. The result of their research is a *REAL* straight line frequency condenser that—by accurately and uniformly distributing stations on your dial—assures a perfection in tuning that will truly amaze you!

Cat. No. 251B, .00035
Mfd. Max. Price \$3.50

Cat. No. 251C, .0005
Mfd. Max. Price \$4.50

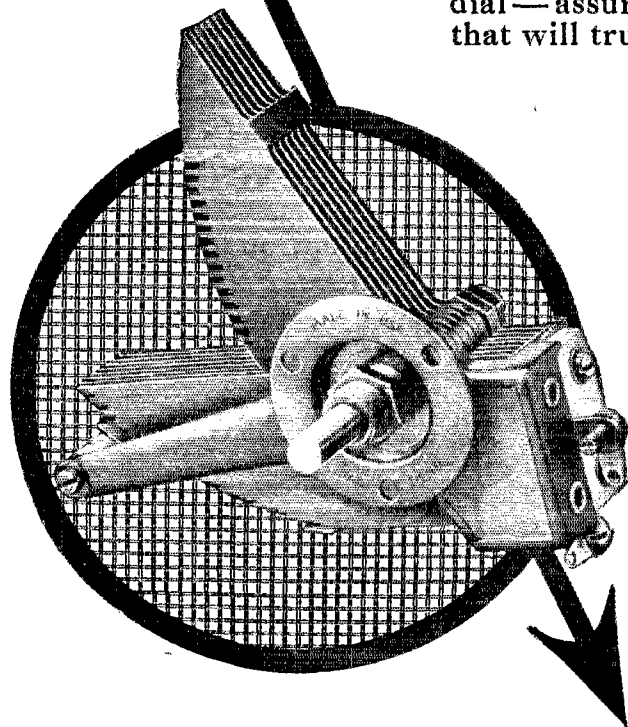

Sturdily built. Electrically and mechanically right—meeting all requirements of low loss design. Mount a *PACENT* Straight Line Frequency Condenser in your set *TONIGHT* and experience the joy of quick, certain tuning!

You will surely be interested in our latest illustrated booklet "*Pacent Radio Essentials*" which you can secure—gratis—from your Dealer—or direct from us.

PACENT ELECTRIC CO.
91 Seventh Avenue
NEW YORK CITY

Washington
Minneapolis
Boston
San Francisco
Chicago
Birmingham

Pacent
RADIO ESSENTIALS

Philadelphia
St. Louis
Buffalo
Jacksonville
Detroit
Pittsburg

Canadian Licensed Manufacturers: White Radio, Limited, Hamilton, Ont.
Manufacturing Licensees for Great Britain and Ireland:
Igranic Electric Co., Ltd., London and Bedford, England

DON'T IMPROVISE — PACENTIZE

“and even the distant stations now come in loud and clear”

A UX POWER TUBE

Will increase volume and clarity in YOUR set, too!

Rewiring Unnecessary

Note: Both the UX-120 tube, which has been designed to increase volume and clarity in all dry battery sets and the UX-112 tube designed to increase volume and clarity in storage battery sets, can be easily applied to any set by the use of a Na-Ald Adapter or Connectorald as shown below.

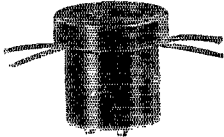

How to improve sets equipped with UV-199 tubes

No. 320 Connectorald

To increase volume and clarity in sets using UV-199 tubes, use the UX-120 tube in the last stage. Easily fitted to the UV-199 socket with a Na-Ald No. 320 Connectorald which also provides cables for attaching necessary extra B and C batteries. Price, \$1.25.

How to switch to dry batteries without sacrificing volume or quality

A UX-120 tube for the last stage with UX-199 tubes in the other sockets provides with dry cells, results previously obtained only with storage batteries. Fit UX-120 tube to the UV-201-A Socket with Na-Ald Connectorald No. 120. Cables provided for attaching extra B and C batteries. Fit UX-199 tubes in all other sockets with Na-Ald No. 419-X Adapters. Price, No. 120 Connectorald, \$1.25; No. 419-X Adapter, 35c.

How to improve storage battery sets

Volume and clarity can be increased in storage battery sets by using the UX-112 tube in the last stage. Easily fitted to the UV-201-A socket with Na-Ald No. 112 Connectorald which provides cables for attaching necessary extra B and C batteries. Price, \$1.25. Mail coupon below for complete adapter information covering use of new tubes in all sets.

ALDEN MANUFACTURING COMPANY

Dept. R3
Springfield, Mass.

All Na-Ald Sockets, Dials and Adapters are protected by patents. Many patents pending.

Alden Processed

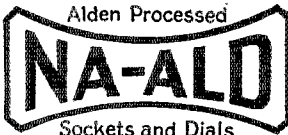

Sockets and Dials

ALDEN MFG. CO.,
Dept. R3, Springfield, Mass.

Please send me complete information on how to increase volume and clarity in any set by the use of the new tubes.

Name
Street
City State



New!

Tone and Volume Control

The new CENTRALAB MODULATOR PLUG gives any degree of tone volume from a whisper to maximum, by the simple turn of a knob. Great for smoothing out powerful local stations, and for lessening static interference. Centralab Modulator Plug can be attached in a moment. No tools necessary. It replaces your present phone plug.

Retails at \$2.50. at your dealer's, or direct from us.

CENTRAL RADIO LABORATORIES

20 Keefe Ave.
Milwaukee, Wis.

Centralab

Kenotron Rectifying Tubes

(Type T.B.I.)

MFD. BY GENERAL ELEC. CO.

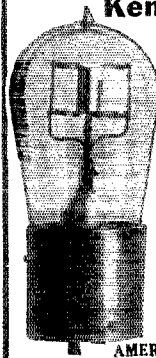

These tubes operate best on a filament voltage from 8 to 10 Volts and draw 1½ amps. For the Transmitter they will safely stand an A.C. input voltage up to 750 Volts and pass plenty of current and voltage for the plate of the Transmitting tube.

They are also used as Rectifying Tubes in "B" Battery Eliminators.

NEW IN ORIGINAL CARTONS

PRICE ONLY \$1.50 Ea.

AMERICAN SALES COMPANY, 21 Warren St., N.Y.C.

PATENTS

TRADE MARKS · DESIGNS
FOREIGN PATENTS

MUNN & Co.

PATENT ATTORNEYS

Associated since 1846 with the Scientific American

640 Woolworth Building, New York City
521 Scientific American Bldg., Washington, D.C.

1310 Tower Building, Chicago, Ill.

633 Hobart Building, San Francisco, Cal.

518 Van Nuys Building, Los Angeles, Cal.

Books and Information on Patents and Trade Marks by Request.

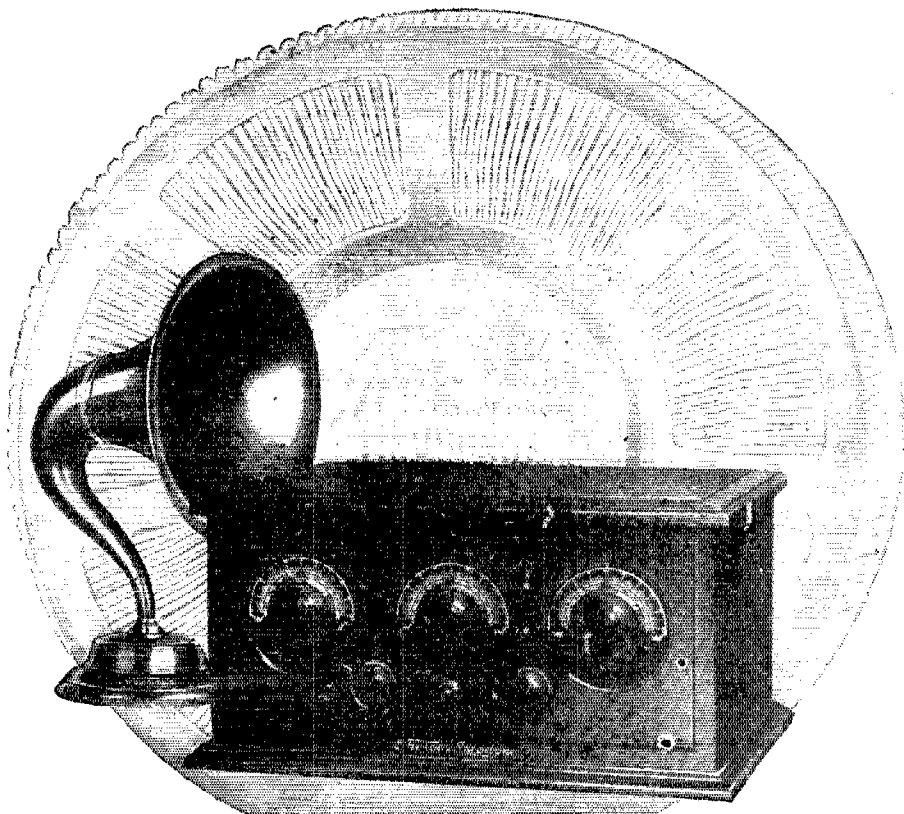

It *Must* Suit You Experts

Specify your own expert test of the Thorola Islodyne—the dealer will comply. Regardless of price comparisons, number of tubes, or style of circuit, Thorola must be best by every standard in your most expert judgment.

Even you have not known performance such as Thorola Islodyne regularly yields. Not only the principle of Thorola Low-Loss Doughnut Coils,

but every phase of Thorola design and construction points real reasons for Thorola superiority to the most critical scientific investigator.

You know much about radio. That is why we value your verdict so highly. That is why every statement here is made most advisedly. You have very likely had any number of sets. Now hear Thorola and know what still lies ahead even for you.

REICHMANN COMPANY, 1725-39 W. 74th St., Chicago

Thorola

ISLODYNE

SAY YOU SAW IT IN QST—IT IDENTIFIES YOU AND HELPS QST

THE SUPER-SYNC

The Only Synchronous Rectifier That Can Be Filtered

When filtered the Super delivers a pure direct current which is often mistaken for storage battery plate supply. The filter circuit used is the ordinary "Brute Force" filter with a small choke inserted before the first filter condensers.

The Super will rectify any voltage up to 4000 Volts at 250 M.A. This range is usually sufficient to supply the ordinary "Ham" transmitter.

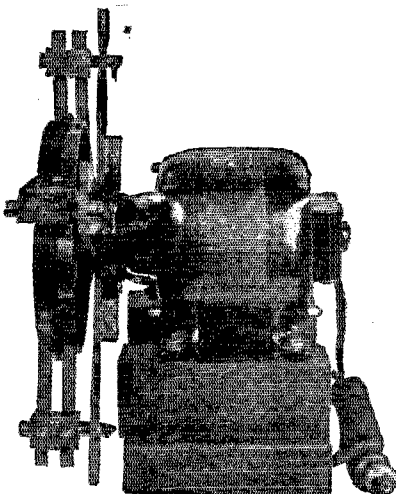

PAT. PENDING
PRICE \$75.00 F. O. B. ST. LOUIS

The commutator on the Super is eight inches in diameter and by reason of its large rectifying commutator will stand up on higher voltages, without break down. This feature also enables the rectifier to give a more full wave rectification.

The commutator is turned over by a 1/4 H. P. Motor made by the General Electric Co. This motor can be supplied for either 110 or 220 Volts 50 or 60 Cy.

MARLO ELECTRIC CO., 5241 Botanical Ave., St. Louis, Mo.

QST!! OSCILLATING CRYSTALS

ATTENTION OWNERS OF BROADCASTING STATIONS.

We are able to grind to your order a Crystal guaranteed to vibrate at your assigned frequency, accurate to better than a tenth of one per-cent. Our crystals are not to be confused with crystals used as oscillators for wavemeter work. Our crystals can be used for wavemeter work, ALSO are ground so they give the necessary output to be used as a MASTER OSCILLATOR in a TRANSMITTER which can easily control a 1X210 tube and get from 7 to 15 Watts of Crystal Controlled energy.

Price \$75.00

For crystals for use in the AMATEUR Bands see Jan. QST.

Scientific Radio Service

Box 86

Radio 3 AJL

Mt. Rainier, Md.

RARE GAS AND HIGH VACUUM PRODUCTS

Neon, Helium, Argon, etc.

We specialize in construction and development of all types of special thermionic valves, Neon glow lamps, Neon arc lamps, Mercury arc lamps, hot cathode and gas filled rectifiers, tubes utilizing the alkali and alkaline earth metals, and photo sensitive apparatus.

Also, high vacuum pumps, manifolds, etc., made of lead, lime pyrex or quartz glass. Special high frequency apparatus for electronic bombardment.

Flashlamps

1. Neon flash lamps for oscillographs, wavemeters, etc. Price \$3.50.

2. We are the makers of Hyvo—the really safe high voltage indicator.

3. Newest developments in photoelectric cells. Price \$15. Complete equipment for high vacuum work installed.

RADIO ELECTRICAL WORKS
Research Division, 23 Union Sq., New York, N.Y.

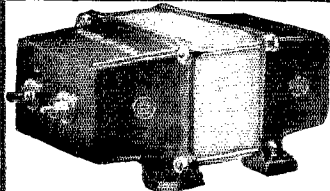

Do You Want a Pure D. C. Note?

FILTER REACTORS

MODEL U P 1626

INDUCTANCE 25 HENRIES, D. C. RESISTANCE 335 OHMS
DESIGNED TO CARRY 160 MILLIAMPERES

BRAND NEW IN ORIGINAL CRATES

SPECIAL PRICE \$5.50 Ea.

AMERICAN SALES CO., 21 WARREN ST., N. Y. C.



MAKE US AN OFFER

On 100 Watt Sending set of Radio Station KGB. Write:

JAMES E. MACPHERSON

c/o Tacoma Ledger, Tacoma, Washington
for Particulars.

BUILD THE NEW FIVE TUBE

Hammarlund
Roberts
RECEIVER

Send 25c for complete "How to Build It" Book
Hammarlund-Roberts 1182-P Broadway New York



This illustration of the receivers operating unit shows how the antenna circuit, at left, including coil, condenser and tube, is encased with a heavy, tinned copper shield. It also shows, at the right, three shields which encase the second and third radio frequency stages and the detector stage.

Total Shielding

Permits power for tone quality

All sound reproducing apparatus such as cone speakers require the vibration of a diaphragm. Obviously, **power** is required to vibrate this diaphragm.

The more power you have, and the better the control of the power—the more accurate will be the sound reproduction.

The dream of radio engineers always has been to build a Receiver capable of delivering to a sound-producing apparatus a maximum of accurately controlled power. This is realized in the Stromberg-Carlson Receiver—by the **total shielding** of each radio frequency circuit.

Total shielding permits the use of a third stage of radio frequency amplification. So advantageous is this third stage that weak signals barely heard on a 5-tube receiver are further amplified approximately eight times. The result is properly controlled power for full cone speaker volume with a startling accuracy of tone.

STROMBERG-CARLSON TELEPHONE MFG. CO.
ROCHESTER, N. Y.

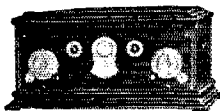

No. 601 Receiver, treasure chest type. 6-tube; totally shielded; dual control; operates horn or cone type Loud Speaker; Equipped with voltmeter; Solid Mahogany. \$210 without accessories.

Stromberg-Carlson

Makers of voice transmission and voice reception apparatus for more than 30 years
SAY YOU SAW IT IN QST—IT IDENTIFIES YOU AND HELPS QST

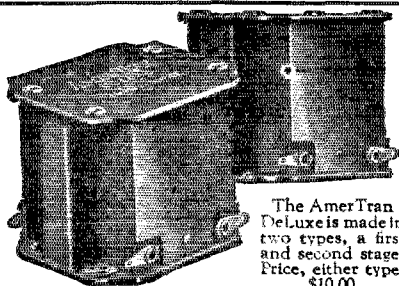

The AmerTran DeLux is made in two types, a first and second stage. Price, either type, \$10.00.

A New Standard of Excellence in Audio Amplification

The realism of this new audio transformer is outstanding. Realism of this kind results from the uniform amplification of the fundamental tones of the lower register. The AmerTran DeLux makes possible the natural reproduction of not only the Overtones, but all of the transmitted Fundamental tones.

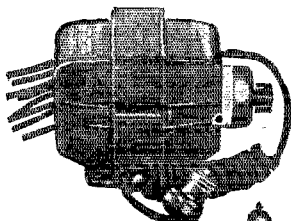

AmerTran Power Transformer type PF-45, Price \$15.00, type PF-52, Price \$18.00.

The AmerChoke type 854 is a choke coil or impedance of general utility. Price \$6.00.

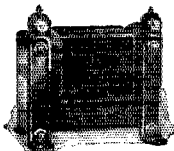

A Good Audio Amplifier

Requires enough plate and grid bias voltage on its tubes to prevent them from being overloaded by the signal voltage.

The AmerTran PF-45 or PF-52 with the half wave high voltage rectifying tubes now available and suitable condensers and resistances—together with three AmerChokes Type 854 will furnish these proper voltages. This combination will give real quality loudspeaker volume. AmerTran Power Transformers also supply A. C. filament current for the last audio tube.

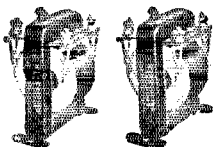

AmerTran Audio Transformers type AF6 (turn Ratio 5) and AF7 (turn ratio 3 1/2) are the leaders in their class. Price, either type, \$5.00.

Write for booklet describing these and other AmerTran Products—with recommendations on their use. It's free on request. All prices are F. O. B. Newark, N. J.

AMERICAN TRANSFORMER CO.

178 Emmet Street, Newark, N. J.

"Transformer builders for over twenty-five years"
Sold Only at Authorized AmerTran Dealers.

Public Libraries

in all the leading cities in the United States, as well as hundreds of libraries in smaller cities and towns, have on their shelves one or more copies of the new radio text book

"Radio Theory and Operating"

By MARY TEXANNA LOOMIS

Also in use by practically all of the leading Radio Schools and many of the Technical Colleges.

850 Pages **670 Illustrations**

Price \$3.50

Postage paid all parts of the world. If you desire a copy, ask your local dealer to supply it, or send check or money order to

Loomis Publishing Company,

DEPT. T

405 9th St. N. W. Washington, D. C.

RADIO OPERATORS WANTED

Radio Operators are needed on board ships sailing for Europe, The Orient, Africa, South America, etc. THE EASTERN RADIO INSTITUTE can train you quickly and thoroughly because:

MODERN and EFFICIENT METHODS
THOROUGH yet Simple INSTRUCTION
New and UP-TO-DATE APPARATUS
THIRTEEN Years a RADIO SCHOOL

The OLDEST, LARGEST, and MOST SUCCESSFUL school in New England. RECOMMENDED BY THE A. R. R. L.

Day or Evening Classes Start Every Monday.

Write for Illustrated Prospectus

EASTERN RADIO INSTITUTE

899 BOYLSTON STREET
BOSTON, MASS.

R.C.A.
UC-1015



\$1.25
EACH

The Best Condenser for Short Waves

1. It stands 7,500 volts.
2. The insulation is sulphur and mica.
3. Eleven different capacities make close tuning easy.
4. No capacity variation to change your wave.
5. Universal for blocking, by-pass and tuning purposes.

Make your set the best with these condensers. Only \$1.25 each, postage prepaid anywhere in U. S.

Utility Radio Co., 58 No. 6th St., Newark, N. J.

Send for this RADIO 1926 Catalog of RADIO BOOK BARGAINS Save 1/3 to 1/2

The World's Largest Exclusive Radio Mail Order House Will Send You This Wonderful Book FREE



AMERICAN RADYNOLA 5 TUBE SET

\$29.50

64 illustrated pages containing thousands of bargains in radio sets, semi-finished sets and radio kits of all styles, sizes and approved circuits. 5-tube sets as low as \$29.50. Beautiful models of the very latest designs and types. Elaborate console models with loudspeakers built right in cabinets of genuine mahogany and walnut. All sets guaranteed. Coast to coast receiving range. Also contains everything in radio supplies, including batteries, chargers, loudspeakers, transformers, condensers, rheostats and any other parts you may want for improving your set or building a new one. Guaranteed saving to you of 1/3 to 1/2.

The Biggest 5-Tube Value on the Market

Positively the world's greatest 5-tube radio bargains. Regular \$75.00 value. Our large quantity production enables us to sell this set for only \$29.50, fully built and wired in beautiful mahogany cabinet of latest design with sloping Bakelite panel of Satin finish, handsomely etched and engraved as illustrated. Constructed of the finest low-loss condensers, coils and sockets. Bakelite baseboard panel and dials. Price for set only. **\$29.50** Transportation charges extra, shipping weight 25 lbs.

This set with all accessories, including the famous American Bell loud speaker with adjustable unit, 2-45 volt "B" batteries, one guaranteed 100 Ampere Hour storage "A" battery, cable for battery connection, 5-201A tubes, Aerial and ground equipment, and everything complete ready to set up and operate. Nothing else to buy. Price **\$59.75** Transportation charges extra. Shipping weight 100 lbs.

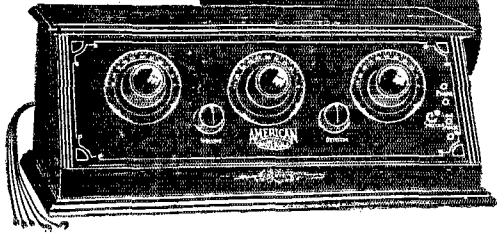

Order Direct from This Page! Save About One-Half!

Order direct from this page. Save 1/3 to 1/2. Our guarantee protects you. Money cheerfully refunded if you are not satisfied. Write your order and prices plainly. Send post office money order or bank draft for full amount to insure safety. Refer to any bank or commercial agency regarding our reliability.

SEMI-FINISHED 5-TUBE RADIO FREQUENCY SET

\$18.75

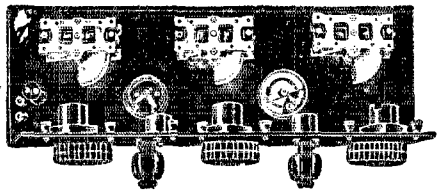

This special offer is astounding the radio world. Coast to coast reception on loud speaker. Low loss condensers and sockets. Highest quality transformers. Bakelite rheostats. All wiring concealed under Bakelite baseboard. 7x18 panel—fits into any standard 7 1/8 cabinet. Complete instructions for wiring. Guaranteed saving to you of \$3.00. Price of set all mounted, \$18.75. Cabinet of same model as American Radynola pictured above \$5.65 extra.

You must have our catalog no matter what set or kit you want. Our line is complete and includes all popular sets, such as Superheterodyne, Neutrodyne, Ultradyne, Reinartz, Regenerative, Radio Frequency, Browning-Drake, Super-Heterodyne Reflex and all other latest circuits. Kits, sets and parts manufactured by all well known manufacturers such as Frost, Howard, Baldwin, Brandes, Western Electric, Columbia and others.

Our semi-finished sets come with all parts mounted on panel and baseboard ready for wiring. Do not fail to send for our catalog. Remember—we are the largest exclusive radio mail order dealers in the world and carry the best of everything in radio. We save you 1/3 to 1/2 on the following kits. Detailed descriptions appear in our catalog.

SEMI-FINISHED 8-TUBE SUPER-HETERODYNE

\$43.75

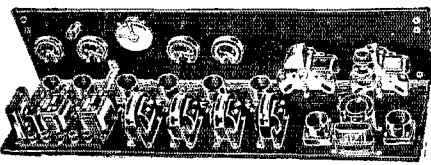

World's Famous 8-tube superheterodyne. Fully mounted on panel and baseboard. Comes completely assembled ready to wire and operate. We have testimonials from thousands of builders of this set. Some have received foreign stations on loop aerial. Unsurpassed in volume and tone quality. Low-loss straight line frequency condensers, vernier dials, finest quality rheostats. Matched Columbia long waded transformers. Requires only three screws for attaching panel and baseboard and set is ready to operate. 7x30 panel. Price of set only \$43.75. Requires following accessories to complete this set: 7x30 cabinet, 8-201A tubes for storage battery operation or No. 199 tubes for dry cell operation. 100 Ampere hour storage battery, 2-45 V "B" batteries, loud speaker, center tapped loop aerial. All these items are listed in our catalog at a tremendous saving.

Complete Parts for Best 45 Kilocycle Super-Heterodyne Genuine Remier Parts **\$49.50**

Catalog includes list of broadcasting stations, general radio information and facts about our free service division. Write for it today.

NEUTRODYNE
Genuine licensed Neutrodyne kit of parts, come fully assembled on the panel and baseboard with complete instructions. Price, **\$29.75** ready to wire.

COCKADAY
3-tube Cockaday kit of parts, fully assembled on panel and baseboard ready to wire. Price **\$15.85**

LOW LOSS SHORT WAVE
3-tube set—25 to 100 meters. Fully assembled on panel and baseboard, ready to wire. Price, **\$19.80**

HARKNESS
2-tube reflex kit of parts, fully assembled on panel and baseboard, ready to wire. Complete instructions. Price, **\$16.95**

RANDOLPH RADIO CORPORATION

159 N. Union Ave. Dept. 265 Chicago, Illinois

A BETTER AND DIFFERENT PLUG-IN COIL

Note its advantages listed below—and try and do without it!

1. Positive contact is secured through General Radio plugs and jacks.

2. With 3 Coils, continuous, gapless range is secured from 140 to 16 meters. One of the 20-40-80 meters amateur bands is located in the middle of the tuning range of each of the 3 coils. (For this a SFL Condenser, 140 mmfd. max. cap. is essential.)

3. Operation of regeneration condenser has no effect on the tuning; the 2 controls are completely independent.

4. Antenna coupling is adjustable; done by a primary coil

and not through a condenser. Secondary coils are specially constructed so that setting of primary coil does not need to be changed when secondaries are exchanged.

5. Coils are space-wound solenoids on skeleton frames.

6. Both tickler and antenna coil are at filament end of the secondary.

7. These coils cover the 3 U. S. Amateur Bands, all European Amateur Bands, Short-Wave Broadcast, U. S. Naval and Commercial Short-

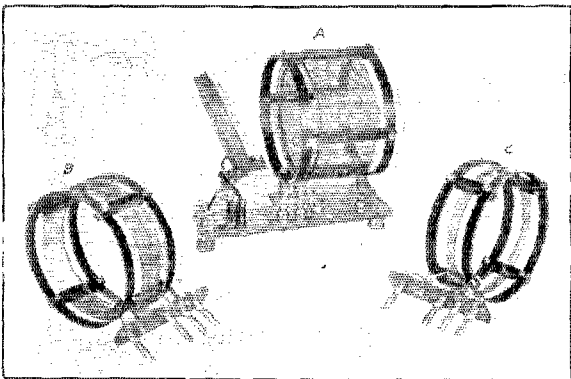

PRICE \$12.50

Wave Stations, etc.

These coils are essential to the most efficient operation of your station. Order your TODAY.

AERO PRODUCTS INCORPORATED, 1772 Wilson Avenue, Chicago, Illinois

EAGLE



All That's Best in Radio

Eagle Owners have the satisfaction of knowing they have the best Radio Receiver made, regardless of cost.

Ask Your Dealer



EAGLE RADIO COMPANY

16 Boyden Place Newark, N. J.

V.T. 14 Transmitting Tubes

Rated at 5 Watts

(MFD BY GENERAL ELECTRIC CO.)
NEW, IN ORIGINAL CARTONS

Filament voltage $7\frac{1}{2}$ Volts.
Filament current $1\frac{3}{4}$ amps.
Normal Plate voltage 350 Volts.
Plate current 40 milli-amps.

Can also be used as modulator or amplifying tube.

PRICE ONLY \$1.50
EA

American Sales Co.,
21 Warren St., N. Y. C.

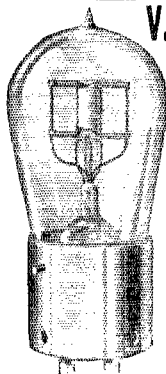

KEEP LOSS DOWN

Dust on the plates of an otherwise good variable condenser will increase losses as much as 50%—especially noticeable when you are working on the shorter wave lengths.

You can keep your set at highest efficiency by using the

Little Marvel Radio Bellows with the special soft rubber tip. Air is the only safe way to clean your set. Order today. Price only \$1.50. Sent Postpaid anywhere in U. S. A. Money refunded if not satisfactory.

J. C. CHRISTEN MFG. CO.
123 Dock St. St. Louis, Mo.

To Jobbers and Dealers: Write for our proposition.



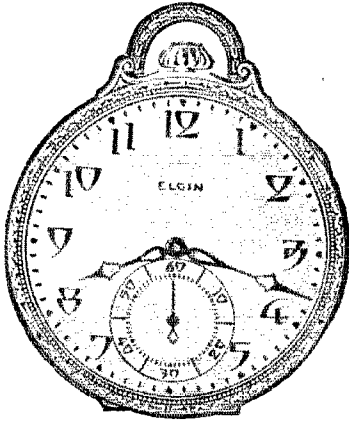

A 21-Jewell solid white gold Lord Elgin watch has been selected as the 1926 Jewell trophy.

“More Miles per Watt”

We mailed a copy of our circular “More Miles per Watt” to every American and Canadian amateur, giving rules for the Jewell 1926 Contest. Did you get your copy?

NOW—

We are modifying this contest so that in addition to the Lord Elgin grand trophy, we shall give a No. 64 Jewell Thermo Couple Ammeter to the man in each district with the most miles per watt. Remember, the contest closes May 1, 1926.

**Jewell Electrical Instrument
Company**

1650 Walnut St.

Chicago

U. S. A.

A Jewell Pattern No. 64 thermo couple ammeter will be awarded to the man in each of the 18 divisions of the A.R.R.L. who gets the most miles per watt in this contest.

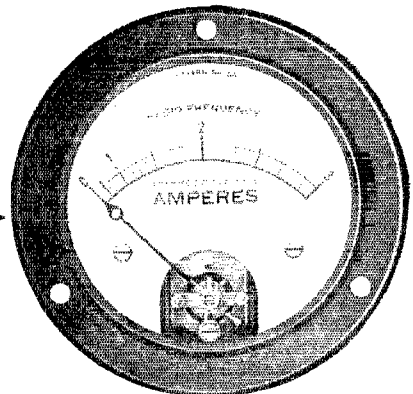

"The enchantment of distance,
the joy of clearness, with
FROST-FONES"

NEW! BETTER!

Two useful new items of **FROST-RADIO**
now ready

A new **FROST-RADIO** socket that
fits all new type tubes

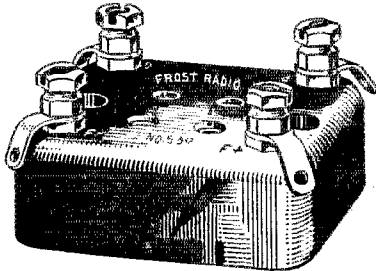

FROST-RADIO

No. 530 **FROST-RADIO**
SOCKET . . . 40c

This new socket takes ALL tubes with the new type bases. Has perfect spring construction which grips each tube prong full length with self-cleaning, sliding contact. We believe this socket to have the most satisfactory contacts of any socket made. All terminals plainly marked. It is equipped with soldering lugs. Genuine black Bakelite in high lustre finish. Order from your dealer today.

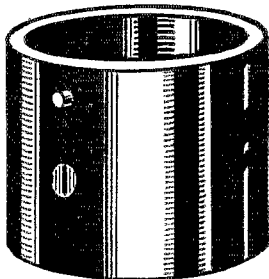

FROST-RADIO

No. 540
FROST-RADIO
ADAPTER . . . 25c

Convert your present standard
sockets to UX199—CX299, or
UX120—CX220 with this
adapter

With this handy, inexpensive adapter you can instantly fit the new CX299 or UX199, and the CX220 or the UX120 into your present standard base sockets.

No need to rebuild your set to take the new tubes. Genuine black Bakelite—high lustre finish. Ask your dealer to supply you.

HERBERT H. FROST, Inc.
314-324 WEST SUPERIOR ST., CHICAGO, ILL.
New York City Cleveland Kansas City
Los Angeles

Export Office: 314 West Superior Street, Chicago, Ill.

Three "E" Straight Line RHEOSTAT

Perfect Control
of Filament
Temperature

Illustration 1/2 size. 6-15-30 Ohms

**WATTS,
4 FM**

tells you about this precision instrument straight from the shoulder.

Patent Pending

Gives you a fine, smooth, dependable variation of filament temperature. Runs smoothly, is absolutely NOISELESS, and once set, "stays put!" Sets a new standard of Rheostat performance, doing things that no other rheostat is expected to do. Used in the R. F. filament circuits of Neutrodyne and tuned R.F. sets, it controls volume smoothly, and without distortion, over the entire range. Equally efficient for short and long wave sets. By all means secure this precision instrument at once. Ask your dealer or order direct. Price \$2.50, Postpaid.

"Florida Radio Telegraph Co., Central Station W. Ft. Miami, Fla. . . Working on 15 to 40 meters . . . I combined the filament rheostat with the oscillation control, thereby eliminating one variable condenser and its attendant effect upon tuning. Your rheostat has no tuning effect whatsoever and is ideal for this purpose. I intend to equip the stations of this Company with it. E. G. Watts, Jr., 4FM"



Electrical Engineers Equipment Co.
Radio Division

708 W. Madison St., Dept. 7, Chicago, Ill.

Information on Request

HERCULES AERIAL MAST

We pay freight
20 Ft. \$10. 40 Ft. \$25. 60 Ft. \$45.
All Steel Construction
Complete with guy-wires etc.
Mail the Coupon
S.W. HULL CO. Dept. D 2048 East 79th St. Cleveland, Ohio
Please send free the full details about the "HERCULES" Aerial Mast.

For SELECTIVITY TRY
U. S. TOOL
STRAIGHTLINE FREQUENCY CONDENSERS

Made and Guaranteed by
U. S. TOOL COMPANY, Inc.,
AMPERE NEW JERSEY

Transmitting Grid Leaks

5,000 ohm and 10,000 ohm General Electric Units

Here you are, fellows, just what you have been QQ-ing for. Brand new enamelled porcelain GE gridleaks in 5,000 ohm and 10,000 ohms sizes for all tubes. There is a limited supply so QSL quick. Prices 5,000 ohm \$1.25 and 10,000 ohm \$1.75.

Postage prepaid anywhere in U. S. Order Now!
UTILITY RADIO CO., 58 No. 6th St., Newark, N. J.

The KARAS Orthometric Straight-Frequency-Line Condenser

*Especially built for
Amateurs' short
wave work at the
suggestion of Lieut.
F. H. Schnell.*

**Built to the Specifications You Would
Write If Buying Condensers
Made to Your Order**

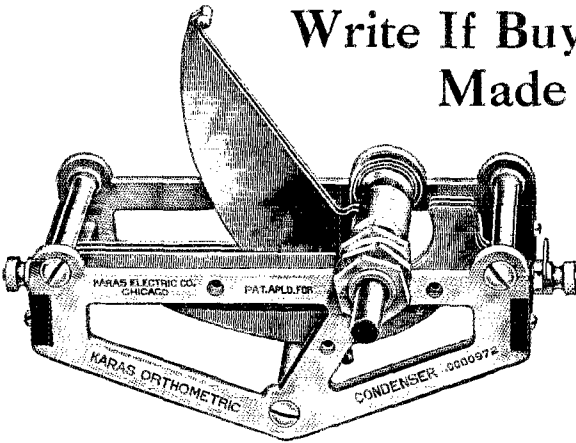

PRICE \$6.50 EA.

- 5 Plate**
Max. Cap. .0001 Mfd.
Min. Cap. .00001 Mfd.
- 7 Plate**
Max. Cap. .00014 Mfd.
Min. Cap. .0000108 Mfd.

Supposing you could, have condensers made specially to your order! Write down the exact specifications of the ideal condenser you would like to have for your precision short wave work. Then send for a pair of Karas Orthometric Condensers and compare them point for point with the specifications you have set down.

At first glance you will agree that the Karas Orthometric Condenser, with its nickel-plated frame and brass plates, is the finest looking "job" you have ever seen. But, do not let that influence you. Examine the sturdy construction. Check them from every mechanical and electrical standpoint. Put them in a set. See how they produce a perfectly straight frequency line curve. See how absolutely noiseless they are at the low wave-lengths.

Note the insulated spring copper pigtail—the soldered joints—the smooth working bearings. Make any laboratory test you can devise. Then remember, these condensers have passed tests no one ever thought of applying to a condenser before. Karas Orthometric Condensers have withstood more than 3000 volts A. C. at 40 meters. Losses are so low that no one has ever been able to measure them. Resistance at all capacities is so low that it is negligible.

Seriously, we invite you to make this test. Our 30 day trial period enables you to do so with full privilege of returning the condensers if they should prove disappointing to you in the slightest degree.

**Order Through Dealer or,
Direct on This Coupon**

Due to the widely scattered Amateur demand, this model is not generally sold by our regular retail distributors. Orders will be filled direct at the price of \$6.50, or may be placed through your dealer and his jobber. If you order direct, use this coupon. Send no money. Just pay the postman the price plus a few cents postage.

KARAS ELECTRIC CO.

Manufacturing Plant: N. Rockwell St.,

Offices: 1073 Association Bldg., Chicago, Ill.

Karas Electric Co., 1073 Association Bldg., Chicago.
Please send me.....Karas Orthometric Condensers.
I will pay the postman \$6.50 each plus postage upon delivery. It is understood that I have the privilege of returning these condensers for full refund any time within 30 days if they do not prove thoroughly satisfactory.

Check size desired:

- 5 Plate 7 Plate

Name

Address

If you send cash with order we'll ship condensers postpaid.

To Our Readers Who Are Not A. R. R. L. Members

Wouldn't you like to become a member of the American Radio Relay League? We need you in this big organization of radio amateurs, the only amateur association that does things. From your reading of *QST* you have gained a knowledge of the nature of the League and what it does, and you have read its purposes as set forth on page 6 of every issue. We would like to have you become a full-fledged member and add your strength to ours in the things we are undertaking for Amateur Radio, and incidentally you will have the membership edition of *QST* delivered at your door each month. A convenient application form is printed below—clip it out and mail it today.

.....1926

American Radio Relay League,
Hartford, Conn.

Being genuinely interested in Amateur Radio, I hereby apply for membership in the American Radio Relay League, and enclose \$2 (\$2.50 in foreign countries) in payment of one year's dues. This entitles me to receive *QST* for the same period. Please begin my subscription with theissue. Mail my Certificate of Membership and send *QST* to the following name and address.

.....

Station call, if any

Grade Operator's license, if any

Radio Clubs of which a member

Do you know a friend who is also interested in Amateur Radio, whose name you might give us so we may write him about the League?

..... Thanks!

LOW REL LOSS

SHORT WAVE AMATEUR STATIONS throughout the world are using REL LOW WAVE COILS. They have proven their superiority under actual operating conditions.

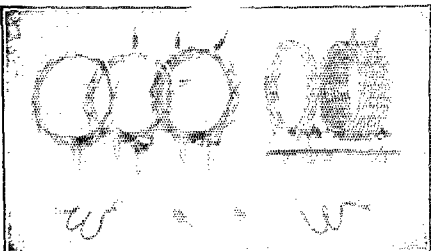

PLUG-IN COILS

1—**RUGGED MOISTUREPROOF COILS.**
Wound with Triple Cotton Paraffined Wire.

2—**NO UNNECESSARY MATERIAL IN THE COIL'S FIELD.**
No Metal Screws. No Circular Bakelite Frames. No Wire Binding Compound.

3—**POSITIVE CONTACT PLUGS.**
The Only One Piece Spring Contact Plug on the Market Today. No Small Parts to Get Loose.

4—**CAN BE USED IN ANY SHORT WAVE CIRCUIT.**
Two Primary Coils. Three Secondary Coils.

5—**COVERS EVERY WAVELENGTH FROM 10 TO 110 METERS.**

6—**PRICED WITHIN THE REACH OF EVERY AMATEUR.**

\$4.50 COMPLETE
(At Your Dealer or Direct)

RADIO ENGINEERING LABORATORIES
27 Thames Street, New York, N. Y.
"The Low Loss Coil Pioneers"

Send for this New Hookup

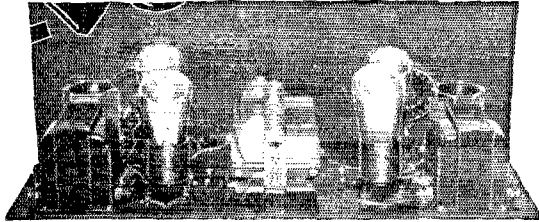

Four Tube Receiver

Here is the outstanding radio receiver development of the season, in which is combined the genius of two of the most successful and distinguished radio engineers, assisted by the engineering and laboratory staffs of seven prominent radio manufacturers. A receiver for the home builder that will represent for several seasons to come a far greater dollar for dollar value than any other design available.

Startling New Features

SINGLE CONTROL—But one tuning or station selector control.

SELECTIVITY—In a residential district of New York City, within a few hundred yards of powerful stations, thirty-five stations were heard between 9 and 10 p. m. on the loud-speaker. KFI, in Los Angeles was heard with ample volume to fill two rooms.

QUALITY—Two new-type Thordarson power amplifying transformers possessing a substantially flat frequency characteristic over the range of 40 to 6,000 cycles, give a superior quality of distortionless reproduction.

VOLUME—Exceeds that of other four-tube receivers, and equals that obtainable from standard five and six-tube receivers.

UNLIMITED WAVE LENGTH RANGE, through the use of interchangeable coils.

WIRING AND ASSEMBLY—All wiring is carried in a special harness. Since each wire is exactly the right length, and has a special color, it is impossible to go wrong in wiring.

Over-all design, rugged and solid. Adapted to practically any standard cabinet, any standard tube, any battery or eliminator source of supply, outdoor antenna or loop. While the parts are the best that the leading laboratories of the country afford, the set can be built at an extremely low cost. Full description of the receiver will be published in the March issue of Popular Radio.

Get the hand book at your nearest Radio Dealer or clip the coupon and send with 25 cents TO-DAY. Address

The S-C Merchandising Company
111 S. Wabash Ave.
Chicago



The S-C Merchandising Company:

111 S. Wabash Ave. · Chicago

Gentlemen: Please find enclosed 25c for which send me hand book of new S-C Receiver.

No choicer group of radio products has ever been embodied in a single radio receiver. Not only are these manufacturers nationally known and accepted as the leaders in radio design and construction, but they have developed for the S-C receiver many new features which will create a new standard in reception throughout the radio world.

Represented Manufacturers:

Belden Mfg. Co.
S-C Wiring Harness

Central Radio Laboratories
Centralab Resistance

Polymet Mfg. Corporation
Fixed Condensers, Leak and Leak Clips

Silver-Marshall, Inc.
Variable Condensers, Coil Sockets, Coils, Tube Sockets, Vernier Dial, Mounting Brackets

Thordarson Electric Mfg. Co.
Equipformer Audio Transformers

Poster & Co.
Drilled and Processed Front Panel and Drilled Sub-Panel

Yaxley Mfg. Co.
Rheostat, Jacks, Switch

NAME _____

ADDRESS _____

The Inductance

*Used by U-2BBX in
Making His Record
Breaking Transmission
Records*

**20, 40, 80 METER
INDUCTANCES**

I
S
O
L
A
N
T
I
T
E

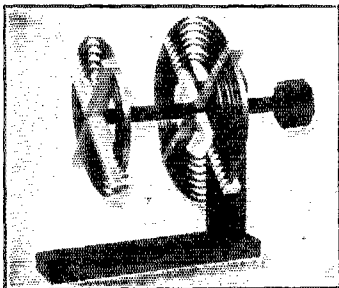

I
S
O
L
A
N
T
I
T
E

INSULATED

\$8.00 postage
extra

Superior to glass as a high frequency insulator. Beautiful appearance. Your O. T. is the heart of your transmitter. Try one of these O. T.s and discover the difference an efficient inductance will make. All wood insulated inductances **\$6.00** postage extra. Complete transmitters in stock 5 watts up

Complete
line
transmit-
ting
parts
in stock
write for
Bulletin

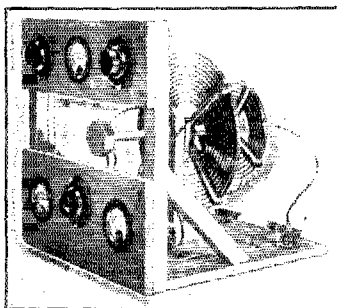

Quartz
Crystals
ground
on
proper
axis
\$6 50

WAVEMETERS - 20 to 200 METERS

Enclosed in Neat Cabinet **\$18.75**
Flash-Lamp Indicators . . . postage extra

With Millimeter Indicator **\$25.00**

Wavemeters Calibrated

New low wave receiving plug-in coils

Write for information

J. GROSS & CO.

907 Fox St., Bronx, N. Y. City

Mailing Address

For Personal Calls—Laboratory, 74 Dey Street

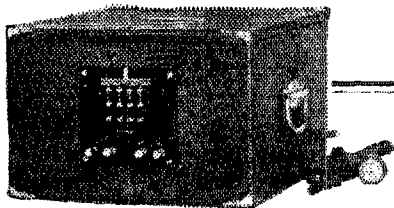

“B” BATTERY POWER
from your
HOUSE LIGHTING LINE

“B” Eliminator Simplicity

Guaranteed Two Years

Line hums are impossible. No costly bulbs or transformers are contained to burn out. No harmful acid—shipped ready for use. Units supplied for 110 volts A. C. or D. C. or farm lighting plants. Write for complete details! Distributors! Everybody!

PRICE 90 Volts Type MX \$27.50
135 Volts Type MX \$32.50

KIMLEY ELECTRIC COMPANY, Inc.
2665 Main Street Buffalo, N. Y.

KIED
MULTI-POWER 'B' UNITS
TRADE MARK

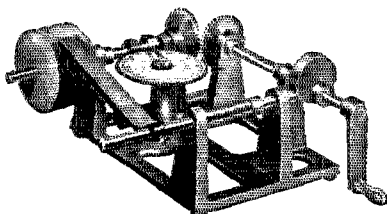

Machine for Winding Honey Comb Coils

With this machine anyone can wind their own low-loss coils to suit their particular requirements. It will wind honey comb type coils any width from one-half inch to one inch and the inside diameter of the coil can be arranged to suit by using various sizes of wooden spools on the winding spindle. It has a recorder with an adjustable pointer for counting the number of turns. Each machine is neatly finished in black enamel and packed in an individual carton. **PRICE \$6.00.**

Get our Agents' proposition.

MORRIS REGISTER CO., COUNCIL BLUFFS, IOWA

*Laboratory
Product*



**CRESCENT
LAVI/E
RESISTANCES**

for Distortionless Amplification

Insure distortionless amplifications and a clarity of tone not obtained through any other resistances. All capacities 12,000 ohms and up. List price \$1.50. Special sizes to order. Write for full information. Crescent Radio Supply Co., 1 Liberty St., Jamaica, N. Y.

COMMERCIAL RADIO PAYS!

You can qualify at home in spare time by our practical courses for Radio Operators—see or hand—Mechanics, Dealers. Or attend our completely equipped School. Arc, spark, and vacuum tube transmitters in operation.

Write NOW for free booklet, **YMCA Radio Institute**
“OPPORTUNITIES
IN RADIO” 159 East 86th St.
New York.

HAM-ADS

IMPORTANT NOTICE! NEW RATES ADVANCED CLOSING DATE

Effective with May QST, the HAM-AD Advertising Rates are TEN CENTS A WORD. Name and address to be counted, each initial counting as one word. These rates are shown on QST Rate Card No. 6, in force with the May issue.

The closing date for HAM-ADS is now THE TWENTY-FIFTH OF THE SECOND MONTH PRECEDING DATE OF ISSUE. For example, all HAM-ADS for the June issue must be in this office not later than April 25.

Hereafter no HAM-AD will be accorded any particular or special position.

Rates for the QRA Section remain the same; 50c straight. See heading of that section for details.

SELL JEWELL high voltage Meter. General Radio Laboratory Condenser, Wavemeter, Audibility Meter. 3AAL. 4602A Delmar, St. Louis, Telephone, Main 0326.

"The Hawley." An alkali un-acid rechargeable "B" storage Battery of 22½ volts. Not an unassembleable battery but ready to use—no extra parts to buy. Uses the largest sized tested Alkaline elements (Edison). Heavy closed top glass cells. Chemical electrolyte included and shipped separate. Any detector or amplifying voltage easily had. Special offer. 4-22½ volts (90 volts) \$10.00; 11½ volts \$12.50; 135 volts \$14.75; 157½ volts \$16.80. For those wishing to put their own together buy the knock-down kits. Put up in all voltages at still greater savings in price. The only battery of its kind sold on a 30 days trial with complete guaranteed satisfaction or your money returned in full without any ifs, ands, or buts. Further guaranteed 2 years. Order direct—send no money. Simply pay expressman its cost plus the small carrying charges. Patent pending. Same day shipments. Write for my guarantee testimonials and literature. It's free and it's interesting. Complete sample cell 35c prepaid. B. Q. Smith, 31 Washington Ave., Danbury, Conn.

TELEGRAPHY—Morse and Wireless—taught at home in half usual time and at trifling cost. Omnigraph Automatic Transmitter will send on Sounder or Ruzzer unlimited messages, any speed, just as expert operator would. Adopted by U. S. Govt. and used by leading Universities, Colleges, Technical and Telegraph Schools throughout U. S. Catalog free. Omnigraph Mfg. Co. 18M Hudson St., New York.

MOTORS—New G. E. ½ HP \$12.50, ¼ HP \$28.50, 1 HP \$45 GENERATORS—Radio Transmission 500V \$28.50. Battery Chargers—Farm Lighting generators all sizes. Lathes, Drill Presses, Air Pumps other Garage and Shop equipment. Wholesale Prices. New Catalog. MOTOR SPECIALTIES CO., Crafton, Penna.

REAL BARGAINS:—R.C.A.U.P 1016 750 watt Power Transformers 3000v with midtap and Filament winding for 2 Fifties, \$12.50—UP 1656 Filament Transformers 75 watt, supplies 4 Five watt tubes, \$4.00—UP 1658 Filament SAY YOU SAW IT IN QST—IT IDENTIFIES YOU

Transformers 150 watt, supplies 2 Fifty watt tubes, \$5.00—UL 1008 Oscillation Transformers, \$5.00—UV 716 Audio Transformers 9/1 ratio, \$2.50—UC 1831 Variable Transmitting Condensers, \$1.50—UC 1803 Antenna Coupling Condensers, \$1.50—Genuine Holtzer-Cabot No. 4 Headphones, 2200 ohms, double pole, high grade, \$3.00—Day-Fan Balanced Vernier Condensers, 7 or 13 plates may be used, Bakelite ends, \$1.50—1000v Mica Condensers, .001 mfd. Bakelite mounted, .25c—Bakelite Navy Key Knobs, .25c—Cutler-Hammer Variable Grid Leaks, .35c—AM-RAD No. 2796 Lightning Switches, \$1.50—Send for discount sheet and keep in touch with bargains. All items sent postpaid up to 4 Lbs. STATE RADIO CO., 286 Columbia Rd., Dorchester, Mass.

EVERYTHING in RECEIVING apparatus. Over 2 pounds data, catalog, etc., prepaid anywhere—25c. Discount to "hams." Kladag Radio Laboratories, Kent, Ohio—if you can't find it anywhere else, ask us as we have the largest stock of highgrade parts between N. Y. and Chicago.

200-20000 METER RECEIVER including Radiotron \$25.00. Two step amplifier \$15.00. Smith, 4416 Market St., Philadelphia, Penn.

NEW GENERATORS, rated at 275 volts 120 watts will give 500 volts \$8. UC1831 variable 4000 volt condensers \$1.50. Bakelite 3 coil honeycomb, geared mountings \$1.50. Western Electric microphones \$1. VT2s \$4, VT1s \$3. Used generators, 30 volt direct current input, output 300 volts \$8. 500 cycle 200 watt \$10. ½ KW \$15. SEND STAMP for list. R. Wood, 38 Way Ave., Corona, New York.

Ex-Govt Material. General Electric 24/1500 volt .233 ampere 6000 RPM dynamotors 112 segment commutator Unused \$45.00. Slightly used \$25.00. Ideal for battery drive. \$3.00 additional for belt drive. Results equally as satisfactory. Crocker-Wheeler 24/1500 volts 450 watts 6500 RPM 100 segments \$45.00. GE 12/350 volts .143 amperes with filter condenser \$18.00. Holtzer-Cabot 12/500 volts .07 amperes \$18.00. All ball bearing machines. 10 volt 20 ampere storage batteries \$5.00. Navy Keys \$2.00. 500 cycle motor generators, Corona Portable Typewriter, excellent condition prepaid \$25.00. Henry Kienzle, 501 East 84th Street, New York.

PURE ALUMINUM and lead rectifier elements, holes drilled with brass screws and nuts per pair 1/16", 1"x6" 13c. 1 x 6, 15c, 1¼ x 6, 17c. 1½ x 6, 19c. single elements half price. Sheet aluminum 1/16", \$1.00, ¼", \$1.90. Lead 1.00 square foot all prepaid. GEO. SCHÜLZ, Calumet, Michigan.

RCA FILAMENT TRANSFORMER, MODEL UP-1656 (75 watt), list price \$15.00, is offered for only \$4.00. Get yours. RADIO SURPLUS CORPORATION, 11-19 Stuart Street, Boston, Mass.

Transformers and chokes, Ham stuff. 9DAL & Co., Arkansas City, Kansas.

\$3.00 New Roller Smith Hot Wire, type CAR Radio frequency Ammeters, from 0-2 to 0-6, amperes, worth \$10.00. We have \$10,000. worth of United States Government Aircraft Department Radio Transmitting Receiving Sets and Parts. Get our new and latest reduced price list. Send stamp for list. Mail orders answered all over the world. WEIL'S CURIOSITY SHOP, 20 South 2nd St, Philadelphia, Pa.

CURTIS - GRIFFITH PRESENTS:—THORDARSON POWER TRANSFORMERS 550 each side \$9.95; SPECIAL POWER-FILAMENT 250-WATT 550 each side \$10.50. ALUMINUM square foot 85c; LEAD square foot 85c. JEWELL VOLTMETER 0-15 AC \$6.95; 0-500 MILLIAMMETERS \$6.95. No. 4000-JA "S" TUBES \$7.50. "HAM-LIST" 3c. CURTIS - GRIFFITH, 1109 Eighth Avenue, Fort Worth, Texas.

TRANSMITTING equipment of WHBI for sale. What do you need? Some real bargains. Chesaning Electric Co., Chesaning, Michigan.

1-20w WESTINGHOUSE transmitter complete with RCA tubes and motor generator \$100. 1 Grebe 18 like new, \$30. 1-8 tube E.I.S. superheterodyne in oak cabinet \$65.00. 1-2 tube receiver with honey-comb coils for long waves, \$10.00. Everything guaranteed. Blum, 935 Ebner Street, Columbus, Ohio.

AND HELPS QST

SELL G.E. 550 volt generator, \$15. 5ATJ, Tuscaloosa, Alabama.

Wanted high voltage transformer 110 to about 2400 at 500 Milliamperes with centre tap. Box 1236, Saskatoon, Sask., Canada.

PARTS for 100 watt transmitter for sale—2BQC being dismantled.

OMNIGRAPHS, ELIMINATORS, VIBROPLEXES, BOUGHT, SOLD, RYAN RADIO CO., HANNIBAL, MO.

WESTERN ELECTRIC 5-watters—New \$25.00, used \$10.00. Westinghouse 250 watt 1000 volt motor generators like new, \$68.50. PDGS.

AMATEUR RADIO EQUIPMENT FOR THE TRAFFIC MAN OR FOR THE DX FAN. DO YOU KNOW N A R I AT KEY WEST, FLORIDA, IS EQUIPT WITH SHORT WAVE TRANSMITTING EQUIPMENT BUILT HERE. 250 WATT TRANSMITTER ON 40 METERS. THE EQUIPMENT BUILT HERE IS USED BY THOSE WHO KNOW. WE BUILD TO ORDER ANY TYPE TRANSMITTER FOR ANY WAVELENGTH RANGE. ANY TYPE RECEIVER FOR ANY WAVELENGTH RANGE. OUR STANDARD SHORT WAVE RECEIVER COVERS FROM 5 METERS TO 200 METERS. QUOTATIONS ON REQUEST. WE BUILD ALSO, HIGH GRADE INDUCTANCES FOR TRANSMITTING OR RECEIVER. ALSO WAVEMETERS TO COVER NEARLY ALL AMATEUR BANDS. WE SUPPLY STANDARD EQUIPMENT SUCH AS GENERAL RADIO, FEDERAL, ACME, THORDARSON, ESCO, ALLEN-BRADLEY, DUBILIER, FARADON, GENERAL INDUSTRIES. WE BUILD BROADCAST RECEIVERS FOR THE TRADE. DISCOUNTS ON THIS EQUIPMENT. ANY TYPE SUPER-HETERODYNE BUILT TO ORDER. ALSO REWIRING SERVICE ON THIS TYPE RECEIVER. WE GUARANTEE ALL RECEIVERS OF THIS TYPE. OUR DEALER'S WIRING AND CONSTRUCTION SERVICE IS OF INTEREST. WRITE FOR IT. IF IT IS AMATEUR RADIO OF THE HIGHEST QUALITY DROP US A LINE. ESTIMATES GLADLY GIVEN. JUST GET QSO. THOS. ENSALL, (RNSALL RADIO LAB.,) 1208 GRANDVIEW AVE., WARREN, OHIO. ("Designers of High Grade Amateur and Broadcast Equipment").

Reg. U.S. BKUMA YRLSBUG Pat. Off.
DODGE RADIO SHORTKUT with APPENDIX and HELPFUL HINTS FOR BETTER KEY WORK Kills Hesitation in Reading Transmitted Code Cultivates and Develops Legible Transmission KEY AND BUZZER HAMS LONG ANCHORED at 12-15 per have by a few hours total practice DOUBLED RECEIVING SPEED

Our Honor Roll tells briefly the experience of TWO HUNDRED LICENSED STUDENTS A story of Rapid Progress and Quick Success by Slow Speed Hams—Previous Failures—Raw Beginners. Facts which should encourage others. But cannot supply the demands of the merely curious. Those interested send 25 cents for copy and use quarter coupon when order. Appreciative Hams who report the fact our Method did DOUBLE OR GREATLY INCREASE SPEED 1BXA, 2EQ, 30CH, 4QY, 5OU, 6QM, 6CDY, 7IE 8BCR, 8BTC, 8DEL, 8ASE, 8BRB, 8BFG, 8ABC 9CHZ, 9CBW, 9CKK, 9CNT, 9APS, 9AIQ, 9EJI Find names in 1925 Ham List or Honor Roll We deliver by Registered Mail—None C. O. D. Appreciate and expect Money Order remittance. SHORTKUT—HELPFUL HINTS and APPENDIX \$3.50 APPENDIX and HELPFUL HINTS only \$1.50 FOREIGN—Except Canada—ADD FIFTY CENTS DODGE RADIO SHORTKUT, Mamaroneck, N. Y.

Antenna rings eight inch diameter. Bronze sixty cents. Aluminum seventy cents each. Harold Riley, Livermore Falls, Maine.

REAL BARGAINS—All guaranteed A-1 condition. Postage extra. Robins Myers 500 volt .2 amp motor generator with rheostat, \$35.00; 200 watt Acme power transformer \$9.75; Allen Bradley rheostat (new) \$5.00; 0-1000 v. Jewell meter without resistance, \$7.00; 50w socket, \$1.00; remote control switch, \$3.75; 4, 4PDT switches without base, 30 amp. size, \$1.00 each; W.E. telegraph relay, \$2.25; Murdock send-receive switch, \$1.40; A.C. panel mounted meters, G.E. 0-15 amps, \$3.75; G.E. 0-75 volt, \$3.50; 0-150v 4 inch face (new) \$6.75; cost 18. Russell Sindt 9DDK, 1509 Washington St., Cedar Falls, Iowa.

HIGHEST offer takes Z-Nith three circuit regenerator. Acme inductance \$3.00. Oscar Rosel, St. Ansgar, Iowa. 9CHN.

FIFTY milliamper 50 henry choke unmounted \$1.75. 110v 60 cycle transformer, Secondary 280v. 50 milliamperes unmounted \$1.75. 110v 60 cycle transformer filament 6v, 2 amperes center tap, secondary 420v, 50 milliamperes, center tap for UX213—\$4.75. VT1—\$2.00. VT2—\$2.50. RCA Thermocoupled ammeter 0-5 \$3.50. 51 unmounted audio transformers \$.90, choke, .005 condenser and 1/2 megohm leak for impedance amplifier all \$2.75. Three winding transformers for UV 201A "B" eliminator \$1.75 choke, for same, \$1.25. Leitch, 50 Park Drive, West Orange, N. J.

FOR SALE: 4 UV204 RCA 250 watt tubes, slightly used, \$40.00. Unity School of Christianity, Radio Dept., 917 Tracy, Kansas City, Mo.

THORDARSON 650-VOLT POWER-FILAMENT TRANSFORMERS for 5-WATERS \$6.90. CURTIS-GRIFFITH, FORT WORTH.

GENUINE! RCA! Brand new! Original crates. UX210—\$7.00, UV203—\$27.50, UV203A—\$34.30. 2AGW. Ham Supply, 2385 Nostrand Ave., Brooklyn, N. Y.

FOR SALE: Complete telegraph equipment of the famous 6XAD at Catalina Island, California, including splendid 500 watt transmitter built by Heintz & Kohlmeier, of San Francisco, and a wonderful receiver, by Townsend. Range of transmitter in QRH: 5-100 meters. Changes made in few seconds. Range of receiver: 5-100 meters—effective over entire range. Price complete—\$750.00. Receiver only: \$150.00. Major Lawrence Mott, Avalon, Catalina Island, California.

WANTED burned out tubes for variety collection. Foreign or odd types. Write 9APM.

1 Omnigraph \$3.50, 1 Double lever Vibroplex \$5.00, 1 Kennedy Universal Type 110 receiver with type 525 two step amplifier, \$55.00. Wm. S. Moul, 121 N. Penn St., York, Penn.

METERS—new cheap. Cooper, 17 Ainsworth St., Springfield, Mass.

\$5.00 NEW United States Government Aviators. Automobile, Motorcycle and Racing Leather Helmet with headphones and microphones, cost \$25.00. Postage free. Limited supply; other Government Radio Bargains. Send stamp for list. WEIL'S CURIOSITY SHOP, 20 South 2nd St., Philadelphia, Pa.

WESTERN ELECTRIC 211-G 50-WATERS \$22.50; USED UV203 50-WATERS \$15.00. CURTIS-GRIFFITH FORT WORTH.

WANTED: Copies of Q-S-T for Jan, Feb, Mar, Apr, Jun, July Aug, Sept, Dec, 1923 and Jan, Feb, Mar, Apr, Jun, July Aug, 1924. Address: Horatio Seymour, (6-VZ) 203 Montana Ave., Santa Monica, California.

SILICON Transformer Steel cut to order .014", 10 lbs. 25 cents, 5 lbs. 30 cents, less than 5 lbs. 35 cents, 4 cubic inches to the lb. .007" for radio frequency transformers, 50c cubic inch, postage extra. At least 1/2 cash with order—balance C. O. D. Geo. Schulz, Calumet, Michigan.

SAVE MONEY by buying RCA POWER TRANSFORMERS for less than 1/3 the list price! We offer you RCA MODEL UP-1016 POWER TRANSFORMER (750 watt), list price \$38.50, for only \$11.50. This is one of the greatest values ever offered in high quality transmitting apparatus. Take advantage of it. RADIO SURPLUS CORPORATION, 11-19 Stuart Street, Boston, Massachusetts.

20 watt C W set for sale. Snye, Rect. Also Magnavox Tone Arm. Write for particulars. Drake Electric Works, 3943 Lincoln Ave., Chicago, Ill.

Silver Plated edgewise wound copper. 9DAL & Co., Arkansas City, Kansas.

HAMS, OBEY THAT IMPULSE NOW. WRITE FOR NEW PRICE LIST THAT WILL END YOUR QUEST FOR TRANSMITTING PARTS, WIRE AND INSULATORS TO MOTORGENERATORS AND TUBES. THERE IS NOTHING MISSING FROM OUR LINE UP. ALL ORDERS POSITIVELY SHIPPED THE SAME DAY

ORDER IS RECEIVED. FORT WORTH RADIO SUPPLY CO., FORTH WORTH, TEXAS.

GENERAL RADIO parts for UNIVERSALS. Many items at special low prices. DOLLAR ASSORTMENTS prepaid again this month. A wonderful assortment of lugs, screws, and small parts. Write for bargain list. BARROWS RADIO LAB., 4-6 Columbia Road, PORTLAND, MAINE.

FOR SALE—Excellent quality forty meter 2 tube receiver. Gets real DX. Twenty bucks. Write—H. Pirie, Fort Dodge, Iowa.

The Best Yet!!! All Wave AMATEUR RECEIVER, with three sets of coils. 10 to 200 meters. In cabinet. SPECIAL \$50.00. Dealers write. LOCUST RADIO COMPANY, 117-19 168th Street, Jamaica, N. Y.

Wonderful new adjustable grid leak .35c. Also adjustable resistances for resistance coupled amplifiers, fits any condenser, no mounting needed, noiseless and moisture proof, 3 stages, per stage .75c prepaid, no condensers included. Also special resistance down to 1,000 ohms 50c each. Spencer Mfg. Co., Aurora, Nebr.

WANT TO MEMORIZE THE WIRELESS CODE? The Corydon Snyder Code Method, Patented, is quickest. Send 25c coin, stamps or M. O. to C. G. Snyder, 1423 Elmdale Ave., Chicago, Illinois.

14 enameled \$4.75 per 1000 ft. 12, \$7 per 1000 ft. Um 533 Hot-wire ammeters 0 to 5 \$1. Roller-Smith radio frequency ammeters 0 to 5, \$3. Uc1831 condensers \$1.60. 1803, 50c. Federal 2mfd tested at 400 volts \$1. RCA super-heterodyne transformers 1716, \$2. 1250 turn honey comb coils \$1. 750 watt 1016 transformers plate and filament windings, \$12. 75 watt filament 1656 \$3.75. Buzzer and key sets, Signal Corp, for learning code \$1.25. Jewelers lathe 4 in. swing 8 collets \$20. 1/4 Hp. General Electric motors ac 110 volt \$12. 1/4 Hp. 32 volt Dc motors \$8. All listed above are new. 120 watt 275 volt generators \$8. Have some 110 volt ac 60 cycle used motors that when direct coupled to 88 generator will give output of 400 volts at 100 watts \$3. Slightly used 500 cycle motor-generator 110 volt to drive 250 watt output \$25. Motor generator 110 volts dc to 300 volts dc at 100 watts, \$20. Dynamotor 10 to 300 \$15. Postage extra. R. Wood, 38 Way Ave., Corona, New York.

WANTED—2 Genuine Double Filament AUDIOTRONS. State price. V. Floyd Huff, P. O. Box 181, Mishawaka, Ind.

LIMITED quantity new Baldwin or Western Electric receivers, \$5.75. Postpaid. Holmes, 126 S. Corona, Colorado Springs, Colorado.

Generator—Crocker, Wheeler,—Navy Type, 1500 volt, 500 watt. \$65.00." W. E. Mueller, 349 National Ave., Milwaukee, Wisconsin.

WE'D LIKE TO HAVE YOU SEE THE NICE THINGS OUR FRIENDS WRITE US, ABOUT THE GOODS WE SELL, THE QUICK SERVICE WE GIVE, AND THINGS IN GENERAL. WE CAN'T REPEAT THEM, BUT YOU CAN EASILY FIND OUT WHY FOR YOURSELF BY TRYING US OUT WITH AN ORDER. ASK FOR THE FREE "HAMALOG" TOO, THE ORIGINAL HAM CATALOG. If you are a bona-fide radio dealer, we'll send our discount sheet—name your other jobbers. Such lines as Thordarson, Acme, Paradon, Amrad, Pyrex, Allen-Bradley, Ward-Leonard, Belden, National, Fleron, Goodrich, Sherman, Signal, etc., prove the quality of our goods and our standing with manufacturers. The Amateur's business is our strong suit, and we are prepared to give it the best attention to the smallest detail. WE MAKE EDGEWISE WOUND COPPER STRIP, 1.16" x 3.8" WOUND 6" INSIDE DIAMETER, 12c PER TURN, 4" 10c, STRAIGHT STRIP 5c PER FOOT; ALSO THAT PHOSPHOR BRONZE STAND OFF INDUCTANCE CLIP (SEE JAN. QST. PAGE 27), 20c EACH; 1/4" FLAT BRAIDED COPPER CABLE FOR CONNECTIONS 4c PER FOOT; Genuine Belden-antenna wire, best obtainable. Note new method of pricing, postage prepaid on all antenna wire to any point, up to 25% of value. No. 12 \$1.00 per 100', No. 14 65c per 100', 7x22 stranded enameled, \$1.05 per 100'; Pyrex 7 1/4" insulators \$1.50, 12 1/4" \$3.50, 6" lead-in bowl \$1.50; Sure Fire 20" porcelain insulator, \$1.00; Findlay 6" stand-off insulator, 50c; WARD-LEONARD 5000 OHM GRID LEAKS, CURRENT CAPACITY 200 MILLIAMPERES, \$2.00; RADIOLEAK, VARIABLE TRANSMITTING GRID LEAK, \$5.00; RADIOSTAT, PRIMARY FILAMENT RHEOSTAT \$6.50; Acme 2 mfd. 2000 volt filter condensers \$6.50; 2 mfd.

SAY YOU SAW IT IN QST—IT IDENTIFIES YOU AND HELPS QST

750 volt, \$2.50; Acme .0001 mfd. double spaced variable transmitting condenser, vernier, \$5.50; Acme chokes of all sizes in stock; NATIONAL TRANSMITTING CONDENSERS OF ALL SIZES, WITH NATIONAL VELVET VERNIER DIAL, .0001 MFD., 3/8" SPACING, \$12.50; .00015, 3/16" SPACING, \$7.50; .00023, \$11.50; .00045, \$16.50; NATIONAL RECEIVING CONDENSERS, WITH VERNIER DIAL, 3 PLATE \$5.00; 7 PLATE \$5.50; Amrad 4000-1 S tubes, tested, \$10.00, bases 75c; 50 watt tube sockets \$2.50; Pyrex sockets for UX tubes, 70c; Erla 1000 cycle amplifying transformer, \$6.50; Thordarson transformers of all types. We RENT OMNIGRAPES, SEND FOR TERMS. Try us on your next order, and get the free HAMALOG. Include postage please, with exception of antenna wire. E. F. JOHNSON, 9ALD, Waseca, Minn.

Motor Generator Bargains. Western Electric 110-220 V. Alternating Generator 1500 Volts 500 Watts \$135.00. Robbins & Myers 220 V. 60 cycle three phase; Generator 750 V. 400 Watts \$60.00. Esco 110 V.; Generator 350 V. 100 Watts \$30.00. Robbins & Myers 110 V. 60 cycle single phase; Generator 750 V. 400 W. \$70.00. Esco 220 V. 60 cycle 3 phase 1750; Generator 400 V. 100 W. \$25.00. 110 V. A.C. 260 V. D. C. \$25.00. 220 V. Direct Current Generator 1500 V 500 W. \$75.00. All above machines are ring oiled. Also many others including several 8000 and 4000 W. machines. 1/4 H. P. 220 V. 60 cycle 3450 speed motors \$8.50, 110 V. \$9.50. Write us for prices on anything in motors, generators and motor generators, stating kind of current voltage etc., QUEEN CITY ELECTRIC CO., 1734 GRAND AVE., CHICAGO, ILL.

IVORY RADIO PANEL any size 3/16" thick, 3c square inch. Ivory dial and knobs. Write for FREE sample. Ivorylite Radio Panel Company, 3222 Ave. F, Dept. Q, Fort Worth, Texas.

Better Edison Elements, welded connections .07c pair. Sample cell 10c. Paul Mills, Woodburn, Oregon.

HAMS—REAL BARGAIN genuine Merphon condensers in metal cans, copper soldering terminals, 20 m.f. formed and guaranteed for six hundred volts each \$3.00 postpaid. C. J. Brown, Room 213—52 Vanderbilt Ave., New York City.

EDISON ELEMENT STORAGE "B" BATTERIES THAT ARE DEPENDABLE. COMPLETE IN EVERY DETAIL. 100 VOLT TYPE "A." \$11.00. 100 VOLT HEAVY DUTY TYPE 5-G. \$17.50. WELDED TYPE "A" ELEMENTS, 5c PER PAIR. TYPE 3-G, 6c. 3/4" x 6" TUBES, 3c. SEPARATORS, 1/3c. No. 20 PURE NICKEL WIRE, 1c PER FT. No. 18, 1 1/2c PER FT. SHEET SEPARATORS, 5 1/4" x 8 1/4", 5c. SEND FOR COMPLETE PRICE LIST AND OTHER INFORMATION. J. ZIED, 904 N. 5th ST., PHILA. PA.

"CHEMICAL RECTIFIER USERS, SEE MY PREVIOUS HAM-ADS. 101C."

EVERYTHING FOR THE HAM: WE SPECIALIZE IN AMATEUR TRANSMITTING STUFF. SEND FOR OUR NEW CATALOGUE. IT IS YOURS FOR THE ASKING. NO. 12 "DYNEX" SOLID COPPER ENAMELED WIRE 1c FT. NO. 10 (FOR HEAVY DUTY) 1 1/4c FT. PYREX GLASS TRANSMITTING INSULATORS, 8" size, \$1.50, SUPER SIZE, 12", \$3.50. RECEIVING SIZE, 45c. PYREX LEADIN BOWLS, \$1.50. FLERON LEADIN INSULATORS, \$1.10. GAROD-PYREX SOCKETS, \$1.50. ALLEN-BRADLEY RADIOSTATS, \$6.50. RADIOLEAKS, \$5.00, TYPE E-210, \$4.00. BREMER-TULLY PIANO IN HAM TUNER, \$8.00, ERLA 1000 CYCLE HAM AUDIO FREQUENCY TUNER, \$8.00. WARD-LEONARD 5000 OHM GRID LEAKS. NATIONAL TRANSMITTING CONDENSERS, CARDWELL, ACME, GENERAL RADIO, THORDARSON, JEWELL and MANY OTHER LINES OF TRANSMITTING PARTS CARRIED IN STOCK. "DYNEX FOR DX." NICHOLSON ELECTRIC CO., 1407 FIRST NORTH ST., SYRACUSE, N. Y.

COPPER RIBBON 3/64" x 11/32" three cents per foot. Add postage one ounce per foot. R. Nelson, 2910 Exeter Street, Duluth, Minn.

VOICE 5-WATT DX BABIES \$3.15 postpaid, UX-210 7.5-WATT \$8.95. CURTIS-GRIFFITH, FORT WORTH.

ARE YOU AN EXPERIMENTER with A-Battery Eliminators? Then you should have an RCA Filament Transformer, MODEL UP-1658 (160-watt). This instrument lists for \$18.00, but you can get it from us for only \$5.50. RADIO SURPLUS CORPORATION, 11-19 Stuart Street, Boston, Mass.

Good ham dealers carry 9DAL & Co. transformers and chokes.

9DAY—Ten watt transmitter goes for \$75, complete with five hundred volt M.G. in perfect condition. DX N.Z., etc.

NOTICE! 3FA selling out. Bargains in ham apparatus. Send for list. Bonnet, Ridley Park, Pennsylvania.

RADIO AMATEURS. Improve your set with a Faradon Mica Condenser Model UC 1015 made expressly for Radio Corporation. Rated at 7,500 volts, capacity range .0002 to .001 mfd. All brand new and packed in original containers. Instruction sheet enclosed. Originally listed at \$5.25. Price \$1.25, postage prepaid anywhere in U.S. Order Now! Utility Radio Co., 56 North 6th Street, Newark, N. J.

BARGAINS. Eight-tube superheterodyne, twelve-volt dynamotor, generator, modulation transformer. Amos Sorenson, 9CXP, Waseca, Minnesota.

8DTJ for sale. Westinghouse TF transmitter—20 Watts. Set—four 5 Watt tubes—500 volt MG—desk microphone—Key—inductance—lead in insulators—entire set with all equipment for \$140.00. New and good condition. Good record for DX on both phone and CW. R. Schwartz, Buchanan, Michigan.

THE BEST AUDIO TRANSFORMER ON THE MARKET! That's the RCA Audio, Model UV-712. This is precisely the same transformer used in the Radio Corporation of America's commercial receiving sets and sells regularly for \$7.00. OUR PRICE is only \$1.60. Order Now! RADIO SURPLUS CORPORATION, 11-19 Stuart Street, Boston, Mass.

One MSCD motor generator 1000 volt 500 watt 115 volt D.C. motor drive, with starter and automatic release. Excellent condition. Was used as part of broadcasting station. Any reasonable offer considered. Address mail to LeRoy Mark, Colorado Bldg., Washington, D. C.

GOVERNMENT Radio Goods. Tubes British Osram Type C new guaranteed, 75c each. Ballast tubes W.E. new, \$ for \$1.00. Army Airplane spark transmitters, new, guaranteed \$3.00 each. Connecticut and Century Headsets \$1.00. Edison Elements type A guaranteed 3c pair. Edison A Batteries guaranteed type G-4 100 amp., \$3.50. Type A-5 187 1/2 Amp., \$4.00. Type A-6 225 amp., \$5.00. All prices per cell 5 in a case. Modern Radio, 1903 N. 18th St., Philadelphia, Pennsylvania.

EDGEWISE wound copper ribbon, the only really satisfactory antenna inductance .350" wide; 3 1/4" outside diameter 10c turn; 4 1/4" 18c turn; 5 1/4" 15c turn; 6 1/4" 17c turn; 7 1/4" 20c turn, prepaid any number turns in one piece; Geo. Schulz, Calumet, Michigan.

WESTERN Electric 2 mfd. condensers, \$1.00. Tested at 400 volts. Fine for B eliminators. R. Wood, 38 Way Ave., Corona, N. Y.

QUALITY AND QUIET RECEPTION. EXTREME DX. ATTRIBUTES OF YOUR SET IF IT IS POWERED WITH AN EDISON STEEL-ALKALINE B (THE SML KIND). ORDER ONE OF THESE AND YOU BUY SATISFACTION. ELECTRICALLY WELDED FOR ABSOLUTE QUIET. 54 VOLT \$8.25, 100 VOLT \$15.00. OTHER SIZES. OAK CABINET. RUBBER MAT. LARGEST ELEMENTS. REAL EDISON SOLUTION. A BIG BEAR OF A B—2000 MILLIAMPH HOUR FOR THE MULTITUBE SET. 105 VOLTS \$21.00. ASSEMBLED CELLS 24c. SAMPLE 30c. QUANTITY DISCOUNTS. PEPPY EDISON A ELEMENTS 5c. WELDED PAIRS 7 1/2c. GIANT SUPERCELL 4000 MILLIAMPH HOUR 40c. GET SET OF THREE FOR YOUR 199. SAMPLE 50c. ANNEALED TEST TUBES 3/8"-3c, 1"-4c. SHOCKPROOF JARS 1 x 6"-4c, 1 1/4 x 6 1/4" 5c. PUREST SOFT .032 NICKEL 1c FT. .034 (HEAVY) 1 1/4c. RUBBER SEPARATORS 1/2c. REAL EDISON ELECTROLYTE (THAT'S NO LYE) LITHIUM COMPOUND \$1.25. MAKES 5 LBS. WILLARD COLLOID—A REAL B CHARGER \$2.00. JUMBO \$3.00. (FULL-WAVE USE 2). BRING YOUR AERIAL UP TO QST SPECIFICATIONS WITH NO. 12 SOLID COPPER ENAMEL AERIAL WIRE, 75c 100 FT. FOR A PERMANENTLY PERFECT AERIAL. PYREX INSULATORS. LEAD-IN BOWL TYPE PYREX \$1.50. PRESCRIPTIONS FREE FOR AILING B'S. FRANK M. J. MURPHY, 4837 ROCKWOOD ROAD, CLEVELAND, OHIO.

RCA TRANSFORMERS AT BARGAIN PRICES! We offer these wonderful values in RCA Transmitting Apparatus: List Our price
MODEL UP-1016 Power Transformer \$38.50 \$11.50
MODEL UP-1008 Oscillation Transformer 11.00 7.50
MODEL UP-1656 Filament Transformer 15.00 4.90
MODEL UP-1658 Filament Transformer 18.00 5.50
This lot is absolutely new, first quality, and guaranteed perfect. Get your share NOW! RADIO SURPLUS CORPORATION, 11-19 Stuart Street, Boston, Massachusetts.

SELL—Grebe CR8, from storage, good as new, \$25; Esco Motor Generator, 110-60 cycle to 350 direct good \$25; new Jewell meters, 0-350 milliamperes, 0-5 radiation meter, each \$5; General Radio transmitting inductance, never used, \$7. Foster Burgess, Central Village Conn.

Five tube receivers used by air service, two stages audio and two stages radio frequency, mounted in neat wooden box on rubber cords. Sold with cords and connections but without batteries, phones or tubes. While they last, \$4.00. Generator filters, W E make, contain heavy choke coil, two 500 volt condensers, resistances and extension cord. In original cases, \$2.00. 1000 volt W E condensers, one microfarad, 40 cents; 500 volt W E condensers, one microfarad, 35 cents; two microfarad telephone condensers, 30 cents; heavy choke coils 3A \$1.50 each. J. A. Howenstine 2100 South High St., Columbus, Ohio.

NEW LICENSE EXAMINATION QUESTIONS INEVITABLE SOON. PREPARE TO SKETCH A MODERN VACUUM TUBE MARINE TRANSMITTER. COMPLETE BLUEPRINTS OF LATEST SHIPBOARD CW TRANSMITTER. MOTOR-GENERATOR. AUXILIARY BATTERY AND RECEIVER, \$1.00. COMMERCIAL RADIO TRAFFIC MANUAL ONLY BOOK PUBLISHED ON HANDLING COMMERCIAL TRAFFIC, \$1.00. BOTH FOR \$1.50. Howard S. Pyle, 1922 Transportation Building, Chicago.

Q R A SECTION

50c straight, with copy in following form only: CALL—NAME—ADDRESS. Any other form takes regular HAM-AD rates.

1A40—H. H. Cooley, 460 Ward St., Newton Centre, Mass.

1BGA—Donald M. Hood, 73 Buffinton St., Fall River, Mass.

1BKV—Fred E. Gould, Hawley, (P. O. Charlemont), Mass.

1CDS—John W. Helfrich, M. D., 17 Elm St., Westerly, R. I.

1LC—Herman Sanborn, Shrewsbury, Mass.

1ZA—C. E. Jeffrey, Jr., 725 Commonwealth Ave., Newton Center, Massachusetts.

2CHK—Harold Sachs, 161 West 75th Street, New York City.

2JB—B. N. Lazarus, 1729 East 14th Street, Brooklyn, N. Y.

2MK—E. F. Reynolds, Central Valley, Orange County, New York.

2UR—R. W. Finter, 1083 Grove St., Irvington, N. J.

4PF—Henry I. Middleton, Box 370, Hendersonville, N. C.

4WI—O. P. Stufflebeam, 959 S. W. 4th St., Miami, Florida.

5AHP—Arthur D. Tennant, Postoffice Box 6, Lynchburg, Texas.

5AIN—Captain Walter C. Ellis, Second Signal Company, Fort Sam Houston, Texas.

5AJS—R. A. Blane, P.O. Box 592, Goose Creek, Texas.

TRJ ex 7NR—Harold V. Koontz, 1001 East Webb St., Pendleton, Oregon.

SCWK—F. Kelwin Kearney, 5053 S. Martindale Ave., Detroit, Michigan.

9BUG—Ex 1KX-1AXQ, Dick Chase, Cragmor, Colorado Springs, Colorado.

9CJP—Norman Pierce, Jr., 2240 Colo. Blvd., Denver, Colorado.

9DPU—Paul C. Shockley, 1011 N. Madison St., Topeka, Kansas.

9DR O'Rourke & Diehl, 2415 South 50th St., Omaha, Nebraska.

9EAU—O. P. Stufflebeam, 1419 Logan Ave., Marinette, Wisconsin.

11GW—Bruno Brunacci, Via Evangelista, Torricelli No. 1, Rome, Italy.

NIS—D. R. Wingate, U.S.S. Ericsson, C. G. New London, Ct.

The following stations belong to members of the A.R.R.L. Headquarters gang. Mail for them should be addressed care A.R.R.L., Hartford, Conn.
 1XAG R. S. Kruse 1KP F. C. Beekley
 1BAO R. S. Kruse 1OA R. S. Kruse
 1BHW K. B. Warner 1ES A. A. Hebert
 1DQ John M. Clayton

PREPARE FOR SPRING! Send 50c now for your A.R.R.L. automobile emblem! You've seen 'em on other fellows' cars; Doll your own bus up! Tell the world who you are in radio. QST, HARTFORD, CONN.

Improved VIBROPLEX

Reg. Trade Marks
 Vibroplex Bug
 Lightning Bug
Semi-Automatic Transmitter

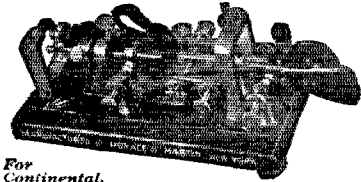

Japanned Base \$17
 Nickel-Plated Base \$19

For Continental, Morse and Navy Codes

Get Yours Now

This is the BUG everybody is talking about. Sends clear, clean-cut signals—the kind you like to hear, simply by pressing the lever—the Vibroplex does the rest. Enables the "ham" to send with the skill of an EXPERT. Used by over 100,000 Morse and Wireless Operators. No radio station complete without an Improved Vibroplex.

Special model equipped with Specially Constructed Contact Points to break high current without use of relay\$25

Sent anywhere on receipt of price. Money order or registered mail.

THE VIBROPLEX CO., Inc.
 825 Broadway, New York

The World's Finest S. L. F. Condenser

"X" LABORATORY TYPE

Used in U. S. Gov't Stations from Alaska to Florida and the Philippines to Sayville. Plates beveled and buffed—Pyrex (glass) insulation—adopted by Am. Tel. & Tel., U. S. Gov't, etc. Made with and without Vernier. Vernier is micro-g geared, ratio 200 to 1. No Back Lash.

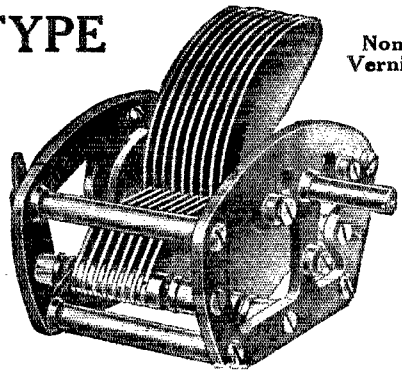

Non-Vernier

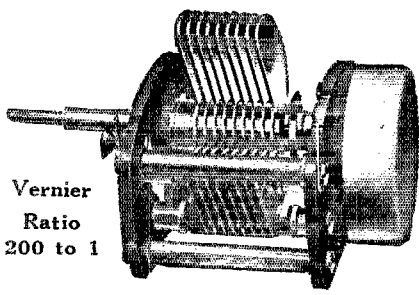

Vernier Ratio 200 to 1

TEAR THIS OUT AND MAIL TODAY!

"X" Laboratories
 29 West 45 St.
 New York City

Enclosed is \$..... (M. O., Express Order, or stamps) for which please ship me

Capacity	Non-Vernier Stripped	Condenser with Dial	With Vernier, Dial and Knob
.00085	<input type="checkbox"/> 7.00	<input type="checkbox"/> 7.75	<input type="checkbox"/> 9.00
.0005	<input type="checkbox"/> 7.50	<input type="checkbox"/> 8.25	<input type="checkbox"/> 9.50

Name

Address

*Perhaps you, too, can cut your
 "B" battery costs in half
 Just follow the chart. It gives you
 the secret of "B" battery economy*

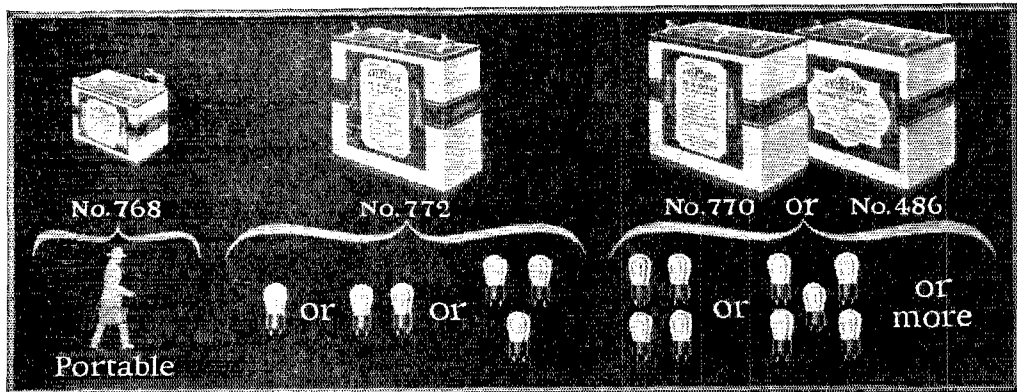

THOUSANDS of people have made the discovery that Eveready "B" Batteries, when used in the proper size and with a "C" battery*, are the most economical, reliable and satisfactory source of radio current.

On sets of one to three tubes, Eveready "B" Battery No. 772, used with a "C" battery, will last a year or longer, usually longer. On sets of four and five tubes, either of the larger Heavy Duty Eveready Batteries No. 770 or No. 486, used with a "C" battery*, will last eight months or more.

These figures are based on the average use of receivers, which a country-wide survey has shown to be two hours daily throughout the year. If you listen longer, of course, your batteries will have a somewhat shorter life, and if you listen less, they will last longer.

Here is the secret of "B" battery satisfaction and economy:

With sets of from 1 to 3 tubes, use Eveready No. 772.

With sets of 4 or more tubes, use either of the Heavy Duty Batteries, No. 770, or the even longer-lived Eveready Layerbilt No. 486.

Use a "C" battery on all but single tube sets.

Evereadys give you their remarkable service to the full when they are correctly matched in capacity to the demands made upon them by your receiver. It is wasteful to buy batteries that are too small. Follow the chart.

In addition to the batteries illustrated, which fit practically all of the receivers in use, we also make a number of other types for special purposes. There is an Eveready Radio Battery for every radio use. To learn more about the entire Eveready line, write for the booklet, "Choosing and Using the Right Radio Batteries," which we will be glad to send you on request. This booklet also tells about the proper batteries for the new power tubes. There is an Eveready dealer nearby.

*NOTE: In addition to the increased life which an Eveready "C" Battery gives to your "B" batteries, it will add a quality of reception unobtainable without it.

Manufactured and guaranteed by
NATIONAL CARBON COMPANY, INC.
 New York San Francisco
 Canadian National Carbon Co., Limited, Toronto, Ontario

EVEREADY
Radio Batteries
-they last longer

Tuesday night means Eveready Hour—9 P. M., Eastern Standard Time, through the following stations:

WEAB—New York	WSAI—Cincinnati
WEAB—Providence	WEAR—Cleveland
WEHI—Boston	WWSI—Detroit
WEAG—Worcester	WGN—Chicago
WFI—Philadelphia	WOO—Davenport
WGR—Buffalo	WGCO—Minneapolis
WGAB—Pittsburgh	WCCO—St. Paul
	KAD—St. Louis
	KGO—San Francisco, 8 P. M.
	Pacific Coast Time

—FOR YOUR CONVENIENCE—

QST'S INDEX OF ADVERTISERS IN THIS ISSUE

Acme Apparatus Co., The	2	Karas Electric Co.	86
Advance Electric Co.	72	Kimley Electric Co.	38
Aero Products, Inc.	82	Loomis Publishing Co.	80
Alden Mfg. Co.	76	Magnavox Co., The	70
All American Radio Corp.	67	Marlo Electric Co.,	78
Allen-Bradley Co., The	3rd Cover	Mass. Radio and Telegraph School	59
Amateur Radio Specialty Co.	72	Morris Register Co.	88
American Sales Co.	76, 78, 82	Myers Radio Tube Corp.	68
American Transformer Co.	80	Munn & Co.	76
A.R.R.L. Application Blank	86	National Carbon Co., Inc	94
Bakelite Corp.	96	National Company, Inc.	73
Bremer-Tully Mfg. Co.	70	Pacent Electric Co., Inc.	75
Bunnell & Co., J. H.	70	Radio Corp. of America	4th Cover
Burgess Battery Co.,	61	Radio Electrical Works	78
Burton-Rogers Co.	74	Radio Engineering Labs.	86
Cardwell Corp., Allen D.	69	Rajah Auto Supply Co.,	66
Carter Radio Co.,	66	Randolph Radio Corp.	81
Central Radio Laboratories	76	Reichmann Co.	77
Cresecent Radio Supply Co.	88	Sangamo Elec. Co.	72
Christen Mfg. Co., J. C.	82	S.—C. Merchandising Co.	87
Crosley Mfg. Co.	71	Silver Marshall, Inc.	68
Cunningham, E. T., Inc.	2nd Cover	Scientific Radio Service Co.	78
Deutschmann, Tohe C.	68	Stromberg-Carlson Telephone Mfg. Co.	79
Dubilier Condenser & Radio Corp.	65	Tacoma Ledger	78
Electrical Engineers Equipment Co.	84	Toaz Engineering and Sales Co.	64
Eagle Radio Co.	82	U. S. Tool Co.	84
Eastern Radio Institute	80	Utility Radio Co.	80-84
Electric Specialty Co.	64	Vibroplex Co.	93
Executivo Radio Council	60	Weston Electrical Inst. Corp.	66
French Battery Co.	1	Wireless Mfg. Co., The	59
Frost, Inc., Herbert H.	84	Wireless Specialty Apparatus Co.	74
Gearhart Schlueter Radio Corp.	64	"X" Laboratories	93
General Radio Co.	62-63	X-L Radio Labs.	74
Grebe & Co., Inc., A. H.	4	Y.M.C.A. Radio Institute	88
Gross & Co., J.	38		
HAM ADS	89-98		
Hammarlund-Roberts, Inc.	78		
Benjamin Hughes Elec. Co.	74		
Hull, Co., S. W.	84		
Jewell Electrical Instrument Co.	38		

ALWAYS MENTION QST WHEN WRITING TO ADVERTISERS



Health and happiness through radio

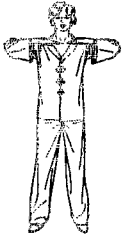

Each morning, young and old everywhere are adding to their store of health by doing the setting-up exercises broadcasted from many stations. Each evening radio adds to their pleasure and happiness through the dance programs.

In developing receiving sets that make the benefits of radio broadcast reception practical for everyone, radio engineers have found Bakelite to be superior for a great variety of radio parts—particularly those that are vital to clear reception and true tonal quality. Bakelite is the preferred material for panels, dials, knobs, condensers, tube sockets and tube bases, plugs, rheostats and for



other radio devices including speakers. In fact, 95% of radio set and parts manufacturers use Bakelite as they have found that its permanently high insulation value, its strength, its lasting color and finish, its immunity to injury through exposure to heat or moisture, make it superior for radio use.

It is always best to make sure that the radio set or parts that you buy are Bakelite insulated.

Write for Booklet 27

BAKELITE CORPORATION
247 Park Ave., New York, N. Y.
Chicago Office: 636 W. 22nd St.

BAKELITE CORP. OF CANADA, LTD.
163 Dufferin Street Toronto, Ontario, Canada



BAKELITE

REGISTERED U. S. PAT. OFF.



THE MATERIAL OF A THOUSAND USES

*The registered Trade Mark and Symbol shown above may be used only on products made from materials manufactured by Bakelite Corporation. Under the symbol "B" is the numerical sign for material of unlimited quantity. It symbolizes the infinite number of present and future uses of Bakelite Corporation's products.

Make Your Radio Set More Efficient With Allen-Bradley Radio Devices

IT matters not whether you are building a receiver or own a factory-built set, in either case you can make your set more efficient by using Allen-Bradley Radio Devices in many parts of the receiver. In addition to the various devices for filament control, grid leak and potentiometer control, there also are the Bradley-switch and the Bradleyner which are easily installed. The one-hole mounting makes installation quick and easy.

TO bring your set up-to-date, replace your old condensers with Bradleydensers and thereby enjoy the selectivity of straight-line-frequency tuning. The condenser is extremely compact and will not interfere with any other parts on your panel. Don't forget the Bradley-Amplifier for perfect audio amplification. This efficient amplifier is a complete unit ready for immediate use in your set. Try Allen-Bradley Devices tonight and hear the difference!

*Insist on Allen-Bradley Products
Sold In Distinctive Checkered Cartons*

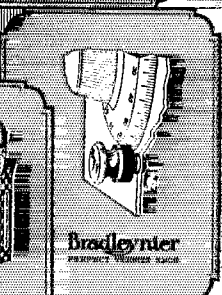
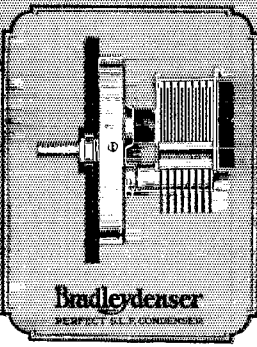
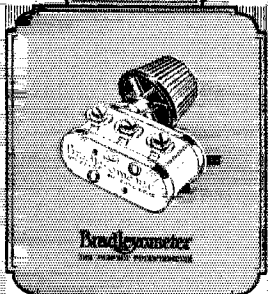
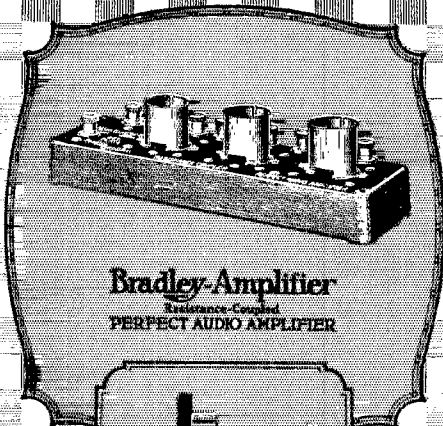
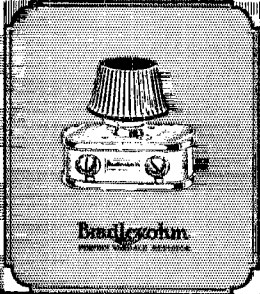
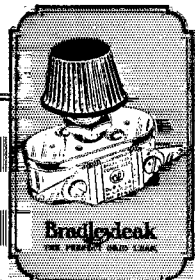
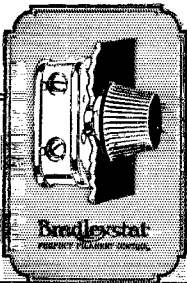

Allen-Bradley Company,
277 Greenfield Ave., Milwaukee, Wis.

Please send me, immediately, your latest literature describing the entire Allen-Bradley line.

Name

Address

.....



who tests your tubes?

WHO makes the vacuum tubes you use? is one important question. Who tests them? is another.

The same great research laboratories that developed the Mazda lamp have developed the Radiotron. The five great factories that manufacture the Mazda lamp, manufacture the Radiotron. And the same genius and the same scrupulous accuracy are behind the test methods developed for the RCA test laboratories.

You would not think of putting into your lighting socket today, anything but a Mazda lamp. Why put into your radio socket, anything but an RCA Radiotron—backed by the same skill, the same engineering and manufacturing resources?

A Radiotron is far more difficult to make than an electric lamp. It demands accuracy to the hundredth of an inch. It demands ten million times rarer exhaustion of the air from the tube. And to guard against error in the turning out of hundreds of thousands of Radiotrons—to insure the high standards of uniform perfection that have made famous the names of RCA, General Electric and Westinghouse, the RCA test laboratories have developed tests delicately exact. When you buy a vacuum tube—know who made and tested it. Look for the RCA mark and the name Radiotron on the base.

RADIO CORPORATION OF AMERICA
CHICAGO NEW YORK SAN FRANCISCO



RCA Radiotron

MADE BY THE MAKERS OF RADIOLAS



The Traffic Department

F. H. Schnell, Traffic Manager
1711 Park St., Hartford, Conn.

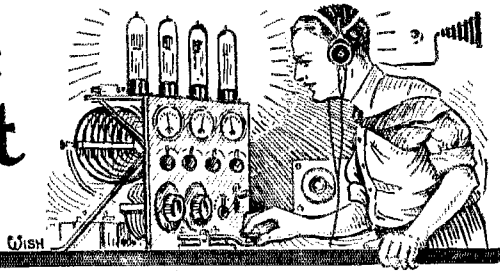

FIFTY-FIVE stations are listed in the Brass Pounders' League this month, the greatest number we have had for many, many months. Yes, it is about two years since we listed a bigger bunch of key punchers. 9SE is way out in front with 913 messages, so we honor him with the box of stars that he may stand out before all hams as the shining example of any leader.

 * D. A. Bancroft—9SE *
 * 7324 Aldrich Ave., *
 * Minneapolis, Minn. *
 * Dakota Division *
 * Orig., 21; Del'd., 14; Ry'd., 878 Total, 913 *

Had 9SE followed the rules last month on the Traffic Trophy, he would be the proud owner of the trophy. He handled 869 messages last month but failed to classify them as **ORIGINATED, DELIVERED** and **RELAYED**.

With the great number of stations listed, we commenced to wonder how it happens there are so many with such good totals. We thought it might be the good conditions at this time of the year. Then we got into the reports and the answer seems to be good condition plus **SCHEDULES**. Each of the stations with big totals has **SCHEDULES** with a number of stations. For example: 9DXY has something like 17 schedules which he keeps with other stations. No wonder he can ring up a big message total and do it without working day and night. There is no getting around it, fellows, the man who has schedules is the man who gets the traffic. Those who complain of lack of messages are merely fishing around haphazardly and picking up loose traffic. What chance has a free-lance got for messages when there are so many stations tied up with schedules during which time messages are moved. The way for **YOU** to get messages is to hook in on some schedules with other stations. You don't need to have a schedule every day in the week—three or four times a week is just that many times better than none at all. Judging from reports in all sections of the country, three or four good schedules in several directions will net you between 90 and 120 messages per month—enough to get you into the Brass Pounders' League. Try it, OM! It may take two or three weeks to get lined up properly and then your business will be to keep your schedules right on the minute.

Incidentally, isn't it a pleasure to keep a schedule with stations and right square on the minute find those stations calling you? And— isn't it disgusting to keep a schedule with some lid who has no regard for time and is anywhere from three minutes to twenty minutes late? There is no fun in that, but there is fun in getting them right on the dot. I recall schedules from NRRL when we had them with 6ZD, 6CGW and 6BUR. There were several others, but these three stand out in my memory because they were **ALWAYS** on time. Some days I could not answer promptly from NRRL, but conditions beyond my control prevented it. Those were happy days and the way we clipped off our stuff was a joy I shall never forget, but it was because we did our work on **SCHEDULE**.

In making schedules with other stations it is well to avoid a monotonous routine—mix them up and add new ones as fast as you find you can handle more of them. Have schedules in several directions if you are located to do it.

BRASS POUNDERS' LEAGUE

Call	Orig.	Del'd.	Ry'd.	Total
9SE	21	14	878	913
1YB	199	63	266	628
9DCG	18	7	425	450
9BFG	53	44	270	367
8EU	140	27	172	339
5VM	285	25	2	312
9HKV	22	26	218	266
9DWN	16	20	228	264
1BFT	56	19	170	245
6RM	133	10	102	245
8GI	7	20	197	224
6BJX	127	38	77	242
9CDV	65	14	130	209
8AYP	67	79	46	192
6ANO	20	9	158	187
9EAM	4	52	126	182
6CCT	25	75	75	175
9RIB	8	12	150	170
9RR	41	27	96	164
9ADI	3	4	148	155
2BL	32	22	98	147
1YC	54	51	40	145
9DOA	50	9	86	145
6ANW	2	2	140	144
6CTN	36	82	24	142
9CZC	2	—	188	140
9CRM	9	4	126	139
9CAA	25	23	62	180
7OT	45	23	62	180
1ATJ	21	10	98	129
6RN	62	67	—	129
3AFW	—	—	128	128
8BRB	46	6	76	128
6BTX	19	6	102	127
9QD	24	14	86	124
6AOA	18	10	96	124
1AOX	21	24	76	121
9FLT	7	5	106	118
6NW	20	7	90	117
2AFV	6	2	108	116
1BYV	77	19	10	106
5APQ	25	7	74	106
8DI	18	60	26	104
2CYX	32	19	52	103
6AIH	11	10	82	102
9EK	96	69	23	198
9BIB	8	19	156	183
9DUJ	1	4	132	137
9DW	56	—	72	128
9EAN	91	6	22	119
9AZN	15	3	102	120
9DTK	117	100	248	465
9DKA	80	25	11	116
7JF	62	10	37	109
8CDB	74	18	112	204

Traffic Briefs

TWO very important changes have taken place in the Traffic Department. One of the very oldest of "old timers" of the division managers, R. H. G. Mathews, known all over as "Matty" has resigned. Matty owned and operated for a number of years 9ZN, the outstanding station of those days. The old spark set at 9ZN rightfully earned the name "rock crusher" because it used to crush through most anything. When CW came, Matty wasn't satisfied with a nibble, he stuck in two big bottles and tore holes in the ether. Matty and 9ZN will always be remembered as leaders. He kept the Central Division at the head of the traffic list for months and months—his gang

simply would let no other division lead in handling messages. Whenever anything new came out, you didn't have to go far to learn that "It started in the Central Division"—the motto which seems to have been taken up by all the fellows.

C. E. Darr (8ZZ) the fellow who makes the covers for QST, has been elected DM—welcome, OM, and whatever you do, keep up the good work. You will find the gang solidly behind you and here's the best o'luck.

M. E. McCreery (6LJ) Southern Section Manager of the Pacific Division has also resigned and in his place we have L. E. Smith (famous 6BUR). McCreery was the real man who put the Pacific Division Traffic Department on it's feet and kept it there all during the time he handled the whole division. Until "Mac" came, there wasn't much of anything doing. Mac was liked by the gang and his services will be missed. In 6BUR there will be a slight change—at least we think so. The amount of work required to run the Southern Section is going to prevent 6BUR from operating as much as in the past. Deep down, I have a mighty respect for 6BUR—one of the fellows who makes a schedule and KEEPS it regularly. 6BUR must stay on the air as much as possible—so do your very best, OM.

Here is the new certificate being sent to those who have filed application for the Army-Amateur Com-

ARMY AMATEUR RADIO STATION



AFFILIATED WITH
THE SIGNAL CORPS
UNITED STATES
ARMY

This certifies that
An Amateur Radio Station _____
owned by _____ *having been duly*
recommended by the representatives of the transmitting radio
amateurs of the United States to serve as the _____ radio station.
if _____ *is hereby designated an*
ARMY AMATEUR RADIO STATION
As such, it is entitled to all the rights and privileges embodied
in the Signal Corps plan of affiliation with the transmitting radio
amateurs. The owners and operators thereof are empowered to
transmit and receive such traffic of an official nature as may be
necessary in the proper performance of their duties.
This appointment will continue in full force and effect for a
period of two years unless sooner terminated for just cause.

Given under my hand and seal
this _____ day of _____ 19____
"4"

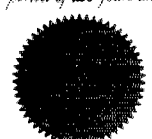

munication System Have you got yours, OM? If not it is because we haven't received your application.

8CNH insists that if you call CQ as specified in the Rules and Regulations, you will get more responses from other stations. He says, "I know there is a host of fellows who will say it is impracticable, but let me ask you—did you ever try it? Once I thought it couldn't be done but one night I tried it and I have tried it again and again with the same results. The way I account for it is that the fellow who listened CQ and consequently thought I would obey the rule to my CQ knew that I was obeying the ARRL rule for DELIVERY of messages." 8CNH's dope is timely and from experience we know it will work, but you must use it consistently—try it, some of you who doubt it.

Why NRRL was not on the air April 14 to 17th!

As I hung over the starboard rail
As sick as I could be,
A guy came out of the wardrobe
An' he says to me says he:

"Oh, the wind will veer and the sky will clear,
And the sea will cease to roar.
I can tell by the sight of your face so white
That you've never crossed before.

I hung some more on the starboard rail,
Then I says to him says I:
"The sky may clear and the wind may veer,
But I wish that I could die.

"I crossed in the winter of seventeen,
An' I never missed a meal.
The more she rolled an' the bigger the waves,
The better a guy would feel.

"I slept in a bunk that was three decks down,
With a hundred more like me,
An' we were as healthy a bunch of gobs
As ever a guy could see.

"But now I can sleep in an outside room,
In a bed with box springs twin.
But I haven't batted a single eye,
For my stomach is outside in.

"I've a seat in the gilded wardrobe,
That I tipped the steward to get.
This is our second day at sea,
An' I haven't sat in it yet.

"In a canvas bunk with a diet o' slum,
I thumbed my nose at the gale,
But now I'm enjoying a cruise de loox
With my chin hooked over the rail."

The guy he coughs an' the guy he grins,
An' the guy he heaves a sigh.
"I think the weather will clear," says he,
An' "Go to hell!" says I.

—F. H. S.

And that is the gospel truth, gang!
Due apologies to R.H.L., of "The Line Book—Chicago
Tribune."

KFZG & KFZH are the calls assigned the Detroit Polar Expedition and whenever you hear them, you will know that Howard F. Mason or George Waskey are at the key. They will use 24 m. (1250 Ks.) 35.5 m. (8450 Ks.) and 73 m. (4100 Ks.) They will be going about the time you get this issue of QST. Remember, all news goes only to North American Newspaper Alliance—nobody else. Be careful, OM!

The 4th Annual Michigan State A.R.R.L. Convention will be held at the Park-American Hotel, Kalamazoo, March 26-27, 1926. Reservation can be made by writing J. A. Wilson, 911 Lay Boulevard, who also will be glad to furnish further information to those interested. Michigan promises a "big time" this year and we expect a large crowd of hams.

There was an old woman who lived in a shoe—but she didn't handle any messages. Look at our traffic total for the past four months. Note how it has grown each month. Then look at the long list of Brass Pounders and note the additional stations each month. We're handling messages better and better each month and getting fewer complaints on DELIVERY, but while we are on the subject of delivery

BE SURE AND DELIVER ALL MESSAGES PROMPTLY!

OUR WALL PAPER—Gosh, gang, you ought to see the flock of cards that rolled in. If we got half as many QSL cards on signs as we did on that Traffic Brief, there would be no kicks. Here is the count by districts up to date: 1st, 58; 2nd, 49; 3rd, 32; 4th, 20; 5th, 32; 6th, 36; 7th, 16; 8th, 36; 9th, 138. Canada: 1st, 5; 2nd, 3; 4th, 1; 5th, 3. British, 3; Coast Guard, 1; Canal Zone, 1 and BCL, 9. Total 489 cards or a total of 8807.639514 square inches—not enough to start papering the walls.

5AEN has the nearest guess to date with 456, but by the time this dizzy idea closes March 5th at noon, I expect to have better than 600 cards. This is the last month, OM—I still need cards for the wall and more guesses. Somebody is going to cop that NRRL 50 watter ar't, and then I guess I'll pick the best card from each district and run a picture of them in Traffic Briefs. Imagine this: a perfectly good 50 watter, one that has been used on A.R.R.L., to the O. R.S. guessing the exact number or nearest the number of cards received on Traffic Briefs. And it doesn't cost a cent!

C. J. Green, ADM Western Mass. (IASU) proposes that each ORS originate at least 10 GOOD messages each month. IASU thinks the more messages we handle the sooner will we become more proficient in code speed and the understanding of how messages should be handled. We agree with him in this and place the suggestion before the gang to find out what some of the rest of you think. Any comments, fellows?

9DTK was listed in the Brass Pounders' League in February with a total of 460 messages. This was in error, his total should have been shown as 681 messages. Sorry, OM, and either you or your DM failed to send in messages originated, delivered and relayed. The Providence Radio Association is planning and working on the coming New England Convention to be held in Providence on April 9th and 10th. Come on gang and you will see that although Rhode Island is a small State it packs a mighty wallop. Let's have a good turn-out.

The Tenth Annual Affair of the Radio Club of Brooklyn was a social and financial success. Over 100 hams and their YL's attended a masque ball. U. B. Ross (2UD) was first prize for the best costume and Miss Estelle Glaser, 2BRB's sister won second prize. First prize was a box of candy and second prize a filament transformer. Prizes were swapped by the respective winners.

SEU and 9DTK do not think any amateur can possibly win the Traffic Trophy. 9DTK thinks the rules surrounding it are too rigid and unfair to the man who is working consistently every month handling a goodly share of messages. It may be that the rules are too rigid and that they ought to be modified to some extent. We set out to put up a worth-while prize of value and we didn't propose to have a scheme where somebody could go right out and walk off with it without showing a very excellent piece of work that was outstanding. Be that as it may, if any amateur has some good practical suggestions for modification of the rules, we most certainly would appreciate them. Please be careful in your suggestions and be sure your proposals are sound ones and

practical ones—we haven't the time to fool around with wild-cat schemes, MIM!

One of the greatest pieces of work we have seen is the log kept by P. K. Leberman (7UZ) of his work with the MacMillan. 7UZ has everything to the smallest detail very neatly arranged in a binder. 7UZ also did some very good work in QSO and QSR of messages for NRRL—our thanks, OM and congrats on the splendid log.

How to get messages. 9CAA reports he encloses a message blank with every message he mails and during the past two months has failed only in two cases to get replies. Good idea, gang, use it!

As a result of our QSZ paragraph in the circular of January 9, there has been a flood of letters shouting for more QRQ and less QSZ, so we did hit the bull's eye. We also are learning that quite a few stations are using break-in and already we have a half dozen articles. Funny what a little squib will do if it hits the right spot.

OFFICIAL BROADCASTING STATIONS

Call	Changes and Additions			Days of Transmission
	Local	Standard Time	Days of week	
	7.00 p m	10.30 p m	12.30 p m	Day of week
5GJ	38	—	—	Thurs.
7DF***	—	—	—	—
7NT****	—	—	—	—
9ADR	—	—	20	Sun.
9ADR	40	40	—	Thurs.
9AIM	40	—	—	Mon. Wed. Fri.
9AYK	41.4	—	41.4	Tues. Thurs.
9BFG	32	32	—	Mon.
9BEI	32	—	—	Tues. Thurs. Sat.
9BXG	30	—	—	Tues. Thurs. Sat.
9CFI	—	—	40	Wed.
9CFI	40	40	—	Sat. Sun.
9DOA	35	—	—	Sun. Fri.
9DPJ	32	—	—	Mon. Wed.
9DPJ	42	—	—	Tues. Thurs.
9DPJ*	—	—	—	—
9DOA	35	—	—	Fri. Sun.
9DWK	200	200	—	Tues. Sat.
9DXY	31	31	—	Wed. Sat.
9EHT	—	40	—	Mon. Wed.
9ER	—	38	—	Tues. Fri.
9TJ	30	—	—	Sun. Wed.
WJBA	—	206.7	—	Tues.
c4GT**	—	—	—	—
c6CT	—	31.5	—	Thurs. Sat. Fri. Sun.

* Sun. noon, 42 m.
 ** Sun. 12.45 A M — 39.6 m.
 ***37.5 m., 7.30 P M, Sat. Thurs.
 **** 39.5 m., 7.30 P M, Wed and 80 m. 9 P M, Wed.

DIVISIONAL REPORTS

ATLANTIC DIVISION E. B. Duvall, Manager

LAST month's report gave some important changes in Eastern Penna. which necessarily gave Western Penna. a chance to follow suit and with these two large and important sections of the Division under new organization and territorial arrangement, there should be a great improvement in the reporting and functioning of traffic system.

The old Dist. No. 7 has been changed to No. 5 with 8XE at the helm as DS. Crossley will have two counties added to the old seventh. The old 8th of Huntington, Mifflin, Blair, Bedford, Fulton and Franklin under the able direction of 8AKI will now be known as the 6th. The old 10th will be the 7th and 8RYI will keep things in shape. The new 8th will consist of the counties Erie, Crawford, Venango, Warren and Forest and Mercer. 8BRC will handle this district from now on. The old 9th remains the 9th.

A noticed improvement in reports reaching here on the required date makes it a pleasure in reporting that the division is in pretty good shape as far as Traffic reports go, however the "Traffic Summary by States" published at the end of the report in the February issue gives us a rather sick feeling. Are we going backwards in Traffic handling? Remember, fellows, I am starting Jan. 1st and keeping a careful

record of every station reporting. Stations who show a decline in keeping their traffic officer informed of activities will be dropped from the list. With the able assistance of several Washington hams, the DM has at last managed to get a set on the air and will operate 3DW on 77 meters. No regular schedule but arrangements will be made for tests with stations applying for the OB appointment.

MARYLAND—ADM—3HG—In only two days of operation. 3TE was QSO N-4DM, 4-MES, A-3LM, A-2CG, A-3QH, A-2YI, A-3HL, and I-1BD. 3PH is now on 40. 3AOJ helped to remodel the station. Dame Rumor has it that 3MP is coming back again. The old 100 watt self rect. set that did such phenomenal work on 80 will be cut down to 40. 3SF has been conducting some extensive antenna experiments, in an effort to determine the optimum type of antenna for his location. 3BMO is now a 40 convert. 3AHA is working foreign stations in all directions. 3RF, 3WA and 3BP are doing their usual stuff! 3ACW is handicapped by 1RM, college worked but relayed 14 messages in 48 hours. 3APT has decided not to quit the game. 3BUR has been off the air due to illness of Midshipman Jordan. 3OU will be back on the air under the direction of Mr. McCracken. 3CGC is QRW school work but manages to get on occasionally. 3VI using a 50 has worked the west coast consistently on 80. 3CJ has a 201A working all districts with 400 volts on the plates on 80. 3HU is doing gud DX on

80. 3FI is on 40. 3AIB is a newcomer on the air, on 40. 3GT is perking on 40. 3APV has just received a new mercury arc rectifier tube. Baltimore ORS should report traffic to 3CGC the OM.

Traffic: 3ACW 17, 3CG 23, 3CGC 3, 3VI 10, 3CJ 17, 3HU 8, 3RF 4, 3GT 8.

DIST. OF COLUMBIA—ADM, 3AB—3BWT states that his station having more than one operator is not eligible for the Traffic Cup race. 3WU is on the air again on 40. Washington is glad to have a new station. 3BKT, who is chiefly interested in Traffic handling. 3CDQ is at last going strong and is regularly reporting quite a number of stations worked. 3JO is going strong on 40. 3AB has gone back on 30. Washington ORS have fallen down on making monthly reports during the past few months. The Washington Radio Club were visitors in Baltimore during this month and paid a visit to several well known Baltimore stations.

Traffic: 3BKT 36, 3BWT 233, 3JO 14, 3ASO 16, 3AB 17.

Stations who do not observe the correct reporting form of traffic originated, relayed, delivered and total will not be given credit.

DELAWARE—ADM, 3AIS—radios that he has been QRW building three ham transmitters for stations in the state.

EASTERN PENNA.—ADM, 3FM—3AEN is experimenting with the new De Forest H tubes. 3BNU is QSO all Dists. and many foreign countries. 3AVM doing good DX work with an H tube. 3CTZ handled a message from Camp Meade to his local police Dept. concerning a stolen car. 3TS, rebuilding his short wave transmitter. 3AFW worked seven 6 dist. stations in three hours. 3CJN, on 40, worked 3ZAC, 3MQ and 3UE, getting out fine. 3AVL blew his transformer. 3AAY is back again and out for new records. 3BVA did some mighty good work during the Xmas holidays. 3ZO is back again and doing a good bit of late operating. 3AUV has been QRW but reports having worked many foreign stations. 3EU leads the traffic list again with real messages. Drug store orders and tracing a lawyer's witness via radio are some of his "stuff". 3CCQ took traffic from NTT at Trieste, Italy and is also QSO So. Africa, Sweden and Holland. 3CFT keeps Bucknell's new 89 meter rig burning. 3BIR rec'd a new H tube via express with the filament in several parts. 3ARP, operating at Gettysburg College. 3JW has practically worked the world according to his list sent in. 3HD handled a few business deals via the air. 3CGS awaiting a new H tube.

Traffic: 3PY 3, 3AEN 4, 3ZM 6, 3BNU 20, 3CTZ 12, 3AVL 4, 3AVM 3, 3MQ 4, 3CJN 37, 3UE 6, 3AFW 128, 3AUV 64, 3ZO 92, 3BVA 19, 3EU 339, 3CCQ 33, 3AVK 14, 3CGZ 8, 3WH 3, 3CFT 2, 3BIR 2, 3BSZ 53, 3DQG 31, 3BQ 18, 3BQP 5, 3CGS 5, 3LW 32, 3AHR 5, 3HD 12, 3AWT 26, 3FS 4, 3BMS 39.

SOUTHERN NEW JERSEY—ADM, 3EH—Interest seems to have picked up since last month's report and stations are handling more traffic than ever. 3BTQ is using a new DeForest H tube on 40 and 80. 3AAN has been busy around the broadcasting station including the transmission of the ARRL broadcast on three different waves and traffic has suffered a decline. 3ZI is making good use of his antenna. Transmission on 40 and reception of broadcasts at the same time. 3CBX has been missing from the air of late. 3BFH is sure knocking them dead with traffic and comes thru with a real report. 3BFF has been ill for some time and is missing from the air. 3CBS is starting up again. 3RE has that dangerous disease, YLitis. 3SJ is using a single VT2 on 80, with 14 watts input. 3CFG reports that he is getting started with a single 201A tube. 3SK reports good communication with SMVS in Sweden and requests that hams look out for SMVS signals on 36. 3SJ has been doing some nice work with SMPZ and Z-2AC. 3KJ has cards from Italy and Australia. Look at the traffic 3JW has piled up this month. 3BO comes thru with a report on working 100 miles without antenna or ground. 3WB and 3RAY are at odds with Jupiter Pluvius and are waiting for a break to get started. 3JW is working schedule with PR-4KT. 3BEI has so much trouble putting up one-man poles in the past that he "went and got a help-mate in an OW". The new QRA of Walt is Oaklyn, N. J. 3AS is getting a bit of the traffic after all.

Traffic: 3AS 16, 3KJ 2, 3BO 20, 3WB 18, 3JW 41, 3BWX 2, 3CO 8, 3BEI 8, 3XAN 1, 3ZI 10, 3CBX 4, 3BFH 14, 3BTQ 19, 3SJ 21, 3DH 181, 3SK 9.

WESTERN NEW YORK—ADM, 3PJ—While the main report was evidently mailed by the ADM, it never

reached the DM. A part arrived in good shape. 3AKS is looking for an ORS appointment. 3BQK has been on with a 201A. 3DX, ex-3BFX is on 79. 3DHX has a new H tube. Has remodelled the Xmitter and antenna system. 3CNH has a good report for traffic handled. 3APU will operate from 2SZ soon. 3VW using a phone and building 20, 40 and 80 sets with DeForest H tubes. 3HJ is trying a schedule with the DM, 3DW. 3AVJ now in a new shack and will be up for ORS soon. 3AFA-3ARG hooked up with SMZS and has a regular sked with 2FA.

Traffic: 3DRJ 32, 3AIL 3, 3AFA-3ARG 20, 3AUJ 33, 3BQK 4, 3DX 8, 3DHX 3, 3CNH 30, 3VW 4, 3HJ 1.

WESTERN PENNA.—Dist. No. 5—Gibert L. Crossley of Penna. State College, 3XE, has accepted the job as Superintendent of this district. The new 5th dist. includes the counties of Potter, Cameron, Clinton, Centre, Elk and McKean. 3XE is operating on 40 and 80 and will be on the "A" and "D" bands soon. 250 watters are used entirely and there are 16 old timers as operators and assistants at the station.

Dist. No. 6—W. K. Aughenbaugh reports amateur activity picking up in the new 6th dist. The new stations are on the air in Altoona. 3BES has opened up with a 50 watter. 3BAA is another new station using a 5 watter with AC plate supply on 175. 3DRA operates a low power phone set for local hamfesting. 3CCI is remodelled, using remote control on his 10 watt fone on 80. 3AHK is temporarily off the air. 3AKI has finished rebuilding and is now operating a 10 watt set and fone on 172 and CW on 150 and 180. Schedules are maintained daily at 10 AM, 6 PM and 2AM. 3AKI would like to arrange schedules with other ORS in the dist. and Western Penna.

Dist. No. 7—3DRB is on 200 but reports very little traffic (try moving down to the 80 or 40 meter band, OM, and get in the swim with the gang—ADM). 3ABW has installed a new MG set and is ready on 40 and 80. He would like to arrange schedules outside the district. (Suggest you work into the schedule reported above for 3AKI at Altoona and make a relay route from Johnstown to Altoona—ADM). 3AUD has had poor luck on 40 and is putting up a new type of aerial. 3BYI is going strong on 42 and getting out very well, a great many DX stations have been worked but very little traffic handled. (Try working up the short relays to Altoona, State College and Pittsburgh, OM. Am sure you will get more traffic and pleasure from this than all the DX put together. 3AGO, Pittsburgh. 3AKI, Altoona, and 3XE, State College, are anxious for schedules—ADM). 3ADS is reported inactive. (Say, OM, try reporting next month or you will be marked in the inactive column and dropped as ORS—ADM).

Dist. No. 8—No report received from the Supt. 3GU reports small amount of traffic on 40 and 80 meters. Regular schedule is being maintained with 3CTB. 3AXD has been inactive this month, having burnt out the field coils of his generator. Repairs are under way.

Dist. No. 9—A. W. McAuly reports 475 messages going through his district alone this month. 3GI is the leader in traffic handling. 3BRB is second best. 3DRB's report is very good considering that he blew up a tube before the month was over. 3DPE has been making repairs to his aerial mast. 3BBL handled some excellent traffic having taken 9 msgs. from NTT, the USS Scorpion while the latter was located at Trieste, Italy. 3DNO is working regular schedules with a 5 watter. 3SF having moved from his former excellent location is now experimenting with various antenna trying to equal the records made at the old shack. (The DS warns all of you hams not to use the Hertz as directly connected transmitters—ADM.) 3DGL is trying the 40 meter band. 3CES would like to arrange schedules. 3CGF is a new station among the active. 3AQG is now ORS with several new operators manning the station. 3CRK and 3AYH also reported but no traffic. 3CEO, the DS, is on the air Monday, Wednesday and Friday nights between 7 and 8 PM E. S. T. The wave is 77.75 and the DS would like to hear from any ham in the new 9th Penna. Dist., which includes the old 9th and 14th.

PITTSBURGH—3AGO comes thru this month with the best t/c report and it looks like he means business. He is working in the 76 band because of lack of traffic on 40. 3BIT has been working on 40 where he finds t/c. 3EW is putting up a crystal controlled outfit at WCAE and will operate on 83.4 meters. 3VE is now the portable call of 3AGO and the outfit is on

the air operating on storage B batteries. 8CLV was on the air very little this month due to business pressure but had time to hook up with QZJT. A "sink" may soon put in an appearance along with some crystal control. 8BVJ reports no activity this month due to his aerial being down. 8BHJ is putting the works back together again and will be on the air in the near future. 8CAZ is a new station in this district.

Traffic: 8GI 224, 8BRB 128, 8DNO 37, 8BBL 36, 8CEO 31, 8SF 8, 8CES 6, 8DGL 2, 8AGQ 3, 8AKI 5, 8CCI 4, 8BAA 1, 8XE 64, 8GU 10, 8BIT 7, 8AGO 87, 8VE 2.

CENTRAL DIVISION C. E. Darr, Mgr.

ILLINOIS—Dist. No. 1: 9BYW is a new 5 watt outfit and worked Porto Rico right off the bat. Ex-9AWU is moving his QRA to College at Peoria under a new call. 9BHT worked several Australians on 38 meters. 9ZA reports that power leak prevents DX.

Dist. No. 2: 9ELR's DX on 85 meters is 7WJ. 9DLO had to mail all his 15 messages. Hi. 9ALF will use straight AC after he finishes rebuilding. 9ELF has ordered an "H" tube. 9RQ will be on the air again about Feb. 26th with a 50 and 40—Logs "A's" and "Z's" often. 9ARM's DX is 4TK es 1KW.

Dist. No. 3: 9AWQ is quitting the game. 9CSW and 9ATT were the only ones to report this month.

Dist. No. 4: 9ELJ has a new super sync rectifier which put lots of punch into his sigs. He worked R-FA 4 the first time he had it working. 9CZL reports considerable YL QRM. 9DQU getting fine results on the new 204-A. Worked five countries one morning.

Dist. No. 6: 9CR rather QRU. 9CEC working on power interference for the local power company so had little time for traffic. 9ALW is QSO East Coast on 40. 9EHQ blew a 5'er and so is out temporarily. 9DGG has a new "H" tube working FB on 20 meters and QSO's Porto Rico on 80 with a 50. 9DQR's second op QSO's with DJ of that station who is attending the U of Cincinnati, 8CAU.

Dist. No. 7: 9AXF uses 40 instead 80 as QRM to BCL's is less there. He delivered 35 messages this month. FB, OM. 9DAF applied for an ORS and has installed a rectifier in place of a motor generator. 9DXG keeps (Reliable) schedules. No traffic for 9RK. 9IX has a chemical rectifier. Wow, 9DYD's 32 jar rectifier froze and popped in his shack. 9NV requests all communications be addressed to station 9NV care of Armour Institute 33rd and Federal Sts., Chicago, Ill. 9MR expects to build another transmitter for 40 soon. 9DWH handles lots of traffic working overtime at Western Union. Hi! He uses a 20,000 ohm grid leak instead of the regular 5000 and reports better results. 9AAE is working hard to put 9AHS on the air. 9AIZ has more power now. 9ALJ is rebuilding and wants schedules. 9DYL is on every night from 6 to 10 on 80. 9CU and 9CNB used one of the two QRM sets of the Chicago Radio Traffic Association and located a defective street lamp. All reports for Chicago must be in the CM's hands. (9DWH) by the 12th of the month for appearance in QST. Correspondence answered immediately. 9CIA has a new set at a new QRA. 9CFS is building 3 transmitters—one for each band. 9EJD is a new 50 watt outfit. 9BFH is on 80 and 150. 9APY has worked 5APQ on an 80 meter schedule every time so far. Works on 40, 80, 150 bands. 9FP is not on much. 9AAW and family are on a tour around the world. 9DLG pounds away on 40 and 80 and 150. 9ALK is in bad with the BCL's school QRM's his radio work. 9BNA was heard in Eng. twice in same morning. Works everything on 40; DX Argentine, CZ etc. 9APY and 9QD hold code practise for BCL's. 9EJX selling out. 9DDS uses his receiver as his transmitter.

Traffic: 9DGG 432, 9QD 124, 9APY 88, 9BNA 87, 9IX 88, 9AXF 76, 9BHT 64, 9NV 60, 9US 59, 9DWH 56, 9EHQ 56, 9MR 53, 9AGW 51, 9AAE 46, 9BVP 44, 9AOL 40, 9CSL 89, 9RK 29, 9ELR 26, 9DXG 22, 9CXG 21, 9FI 21, 9AIZ 20, 9DAF 18, 9DOX 17, 9DYL 16, 9ACW 15, 9DLO 15, 9BIZ 14, 9DAV 13, 9ALK 8, 9DLG 8, 9DZR 8, 9BFH 7, 9KN 6, 9AFF 5, 9DDS 4, 9SN 3, 9ALJ 3, 9AGQ 3, 9ALF 2, 9ARM 2, 9DYD 2, 9AWT 1, 9DQR 1, 9GE 1, 9CZL 46, 9CLJ 5, 9DQU 14.

OHIO—Dist. No. 1: 8CJV, bought out 8CVS who is making a new one. 8AOE is using 50 watts on 80.

8DNR is on with 5 watts. 8DHS is not using his 250 watt yet, account having tough luck getting accessories to go with it. 8AOE reports R4 on west coast on 5 watts. 8LO has schedule 3 nights a week with 1DG, 9BFG and 6AOS. Best DX is 7RJ. 8BSA is moving to Detroit. Sorry to hear of the ill health of 8EQ. He has worked Italy 4 times in 8 nights.

Dist. No. 2: 8ZE is still QSO Australia and New Zealand. 8BKQ is still trying to get his crystal controlled set to work. 8RY received reports from F. A. and CH stations. He is operating a limited commercial station in Kentucky on 40. 8WE has 2 fivers on 80. 8BCE using one 50 watt, received reports from A. Z. and I working HZ stations.

Dist. No. 3: Traffic and DX are surely hitting the high spots these days. None of the stations in this district seem to be able to knock 8BKM out of first place for the number of messages handled. He is working west coast in the day time on 20 meters. By utilizing all wavelengths, he manages to get both DX and traffic. 8ACY was not satisfied with working west coast in daylight with a C301A tube so he went to Sharon, Pa., to the Ham Banquet and took home the first prize, a perfectly good 250 watt. It is now percolating merrily on 20 meters. 8DRX was a winner of a 5 watt at the Sharon Banquet, but was so anxious to receive it from the donor that he dropped it on the floor—it isn't so good now. SADA, 8RF and 8BNH are working everything from Africa and Italy to New Zealand and Australia. 8DAE with a UV201A and from .6 to .8 watt input, has been doing some fine work. So far East Coast is the best DX.

Dist. No. 4: 8ALW got a new M. G. 8CPQ is going FB. Glad to see Dayton back with us again. 8AIB, going strong. 8BON now on 40 to stay.

Dist. No. 5: A report from every ORS this time. FB, fellows, that's the way I like to see it. Had to "jack up" a couple of them after last month, but they came thru FB. Two new ORS applications were approved and their reports received, 8CBI and 8DSY. 8DO, rebuilt and getting out fine, but QRW with college. 8DSY works west coast on a fiver. 8CPB promises to be on regular now. 8EI went dead. 8GZ worked a lot of foreign on 1 watt with a UV199. FB! 8DEM still fooling with Hertz and lives in hopes of getting it perking soon. 8PL is working both coasts at noon on 20. 8CBI is also doing good work on 20 as well as 40. 8BH is QRW school now but swears by the royal wot hong that he will be on sooner or later. 8BAU is putting in H tubes, tho' he's doing FB on his 250 watt. 8RYN is working all the foreigners when power leak allows. Too QRW with another ARRL duties to be on much. The traffic totals show improvement and a lot of the fellows are talking of going back up to 200 meters to handle traffic and use the low waves for DX. Not such bad idea at that. Let's keep up the good work, fellows, and do not drop back in your reports—DS.

Dist. No. 6: 8ATX, using 204A reports plenty of traffic and DX, working 11 countries. 8ATZ is working Italy and Panama on 40.

Traffic: 8ATX 169, 8DBM 127, 8GZ 75, 8BKM 66, 8BYN 62, 8EQ 54, 8ATZ 53, 8DCB 49, 8AOE 45, 8RJ 45, 8BPL 37, 8BAU 33, 8DAE 32, 8AIB 28, 8BSA 28, 8PL 28, 8DSY 26, 8LO 26, 8BON 25, 8DHS 24, 8BSC 20, 8DMX 17, 8ZE 15, 8ANB 15, 8CQS 15, 8DPN 13, 8BQI 12, 8CBI 10, 8CNL 9, 8BKQ 8, 8CPB 8, 8CPQ 7, 8DEM 6, 8BNH 6, 8CWR 4, 8DDQ 4, 8BN 4, 8ADA 2, 8DO 1, 8ALW 1.

INDIANA—Dist. No. 1: 9AVB is logging many foreign stations in the wee hours of the morning. 9AFY finally got his station on the air after having been silent for almost a year. 9AAI finds time to pound brass even tho he made enough super-hets this winter to buy him a new bus. 9DBJ "Hard Luck Bill", lost his fifth 50 watt. Better take down the horse-shoe and try a rabbit foot. OM. 9BKJ had to cancel his schedules on account of local QRM from a near-by Violet Ray machine, and is out after someone's scalp. 9QR is still battin' em out. 9EHU, 9DJZ, 9CRH and 9DWW were home for the holidays and the gang was sure glad to ham with them again. 9EG works both 40 and 80 with an equally good QSB, using either a "sink" or S tubes. 9EJT says DX is good with his five watt, but no traffic. 9DDA works the higher bands with a fifty. He's making friends with the BCL's by locating their power leak interference with his portable super-het. 9EJU is on the 80 meter band with a new H tube. 9CXG is going to take up commercial operating. 9CAP has

four 201-A tubes working FB on 20, 40 and 80. 9EGZ is rebuilding. All new stations are requested to get in touch with 9DPJ, the District Superintendent. 9MM will soon be on with two large tubes (?).

Dist. No. 2: 9ABI made his entire 34 messages in two weeks, receiver dead the rest of the time. 9DHJ has been working all districts with a 5 watter. 9BSK works England on 80 with a 6 watter. Tried 40 but can't get the results. 9BK helping with the BCL organization getting rid of QRM. 9ASX has rebuilt and is going good on 40 now. 9DXI off at the present time due to sickness. 9OG very active. Just worked E-AR2 and EZ-1AB. 9DLZ has a bad case of "Ylitis" and it looks hopeless. 9CCL back on the air and going strong. 9AMI got his 7 1/2 watter, and worked a 6 the first time he hit the key. 9ABP also uses a 7 1/2 watter, but spends so much of his time fixing BCL sets that he don't know much about its ability. 9AEB, working on both 40 and 80 and doing fine. 9BYI is on and 9CPF does most of the operating at his shack. 9ASN will soon be going at Elkhart. 9BUZ-9BMC operates 5 watts between classes. 9BBJ is going again. 9CP, going on a UV204A and getting out good.

Dist. No. 3: 9CSC is working first district stations in daylight on 20 meters. Regular QRH is 38. 9CMJ is going good handling lots of traffic. 9BSC is on again with a 250. 9NG is QRW selling BCL sets and 9BSC is ARW following him up fixing them. 9NG will soon have his "H" tube going. 9EBW handling all of his traffic on 2 201A tubes. A pole raising was held at 9NG's, the pole raisers being 9NG, 9NI, 9BSC, 9AHM and 9EBW. The pole was safely raised midst the usual profanity. 9BEP is a new station going big. 9AHM can't decide whether 80 or 40 is best as both are working okay. 9BUB blew his pet 5 watter. He has a regular schedule with Louisville and handles a great deal of traffic for home town folks at Louisville. An ad he put in the Jasper paper boosted this traffic considerably. Best DX 7JP.

Dist. No. 4: 9ADK is still handling the bulk of the traffic through Indianapolis. 9CUR holds the low power records. He worked two New Zealanders and O-a6N with 40 watts input. 9ASJ handled 98 messages by being on all night every night and sleeping while working. Most of our jobs won't stand that. 9WS will be on the air with his new 200 watt set. 9EJ1 is not having the former good luck with the extreme DX, but still handles plenty of traffic. 9BVZ can't run on account of not being able to get filter condensers that will hold his 5000 volts. 9ADN reports his 203A went west but is on again now with an "H" tube and two operators. 9ES is again back in the traffic handling after a long absence. 9DUC at present QRMed by college work. Will have to quit college.

Traffic: 9CXG 86, 9BSK 76, 9OG 74, 9ADN 50, 9DEJ 46, 9EG 43, 9MM 43, 9AB1 34, 9BUB 34, 9EGZ 29, 9EJ1 29, 9CAP 25, 9ADK 25, 9CSC 25, 9BKJ 24, 9AMI 18, 9BYI 18, 9EBW 15, 9QR 11, 9ES 10, 9CUR 10, 9ABP 10, 9BSC 9, 9EJU 8, 9CMJ 6, 9AVB 6, 9CCL 5, 9BK 4, 9AEB 3, 9BBJ 3, 9ASX 2, 9AAI 2.

MICHIGAN—Dist. No. 1: Traffic dropped off with a bang this month, perhaps due to holidays. Looks, however, as though the gang are not settled on wave bands, all are jumping around from one wave to another which means no traffic. 9CAA will handle student traffic at Ann Arbor. 9DBO on the job as usual and never fails to report. 9ACU says the "Black Maria" paid him a visit but no arrests made. 9CCW is joining the U.S.N.R. and looks for more traffic. 9EF is working night and day, but remembers to report. 9AMS also working night and day. Between times, is trying to get his "H" tube to perk. 9ZH schedules working FB. Has too many transmitters so is enlarging radio room now. Also new tower for another aerial.

Dist. No. 3: 9AUB is working on 40 every noon and wants schedules. 9JG now is QRW on 40 and 80. 9DSE, 9CPY, 9AOI are all using new DeForest "H" tubes on 40. They are great tubes, gang! 9BOK is hitting out again with a 5 watter. 9CCM started up this month and is handling traffic. 9AOR is on 80 meters and on all the time. 9DQB is on again. 9CQG handled a nice flock of traffic this month and has some very good DX records. 9DLX wants schedules. 9DGE will be on with 50 watter soon. His 5er is doing nicely. 9VY sez all he lacks is a power line out to his country estate. Someone loan him one? 9CVQ is the new station of Western State Normal

School in charge of Marburger of 8YN. They have 100 watts and have been QSO Brazil on 40. Ex-9BGR has moved to Sioux City, Iowa and is now 9AHQ. The gang are working hard on the details of the big Michigan Convention to be held at Kazoo, March 26th and 27th. Plans now laid will assure the best convention ever held. If you don't believe it, come and see. \$\$\$ worth of prizes and something doing every minute of the convention. Get lots of sleep now so as to be awake when you get here, gang!

KENTUCKY—9WU is moving his set from his shack into the house as it is too cold to work with any degree of comfort. 9MN is hunting for a new location. 9OX has resigned as DS of Dist. No. 1 much to the sorrow of the ADM. 9DTT was the most active station in the state this month, with the highest traffic total. He explains that he gets most of the traffic by keeping schedules. 9BPB is yet trying to dope out a way to key his big 500 watt bottle. Seems to be afraid of the high voltage. 9EI is QSO anywhere. 9EP will start operation again as soon as the new 50 comes.

Traffic: 9DTT 55, 9EI 12, 9OX 3, 9CVR 1.

DAKOTA DIVISION D. C. Wallace, Manager

NORTH DAKOTA—9EFN-ADM—This is the first report by the new ADM: North Dakota comes on the map once more. 9DLF is working both coast regularly and is on from 1 to 4 AM and sleeps day times. 9AMP is going strong on 40 and 80. 9CRB is doing lots of testing with other hams and getting his filter system in better shape. Not much luck on 80 and works on 125 most of time. 9CZG is using 8 tubes and a new transmitter of 10 watts wants to work the guys, on 80. 9DLF does not get much time building a new set for 40. 9CCT handled 28 msgs. last month and saw no report in QST. Now only 2. Got discouraged when saw no report. Fine work, OM. 9DTQ has been having an awful time on short waves and is on 80. 9DKQ doing fine work using two fivers for rectifiers. 9EFN, the new ADM, has to work the key in the wee hours of the morning.

Traffic: 9EFN 2, 9CZG 5, 9CCT 2, 9DKQ 4.

SOUTH DAKOTA—9CBF-9DB is now the DS of Nr. 2 and all reports should be sent to him. 9DDI is on the air at Milbank. 9CVH has a heavy attack of YL QRM but it will wear off. 9BBF has a new DeForest H tube to go with his fifty, and is doing exceptional work on 40 and 80. 9DWN got his set going during the holidays and handled 264 messages by making and keeping just a few schedules, which goes to show what this schedule business amounts to. 9DXR is only able to get on at intervals. 9DBZ reports hearing South Africa as early as 5PM, along with the South Americans, Aussies cum in R7 to R8. 9NM is on the job for QSR. 9CBF and 9BDW are assembling a 1KW station which will operate as 9DB. 9DGR is another who tried the schedule business and reports it FB. 9DAJ is a new ORS. 9BDW is still working Aussies. 9BKB had a fiver go west and one go soft and the coal man tore down his counterpoise. 9CJS reduced power and finds it is much better. 200 watts on a fiver is possibly a trifle too much any way. 9CAJ was operating the set at 9CJS when the lead in came down, the radiation went up and he kept right on working with no one knowing the difference. Operating with an antenna six feet long, lying on a wet ground, and getting out R6 several hundred miles. 9AGL got a DeForest H.

Traffic: 9CBF 12, 9DGR 96, 9BDW 18, 9BKB 10, 9NM 5, 9DBZ 48, 9DWN 264, 9BBF 7, 9CJS 44.

MINNESOTA—Dist. No. 1: 9EGU hands in a fairly good message total as a result of schedule work. 9CWN claims his new chemical rectifier just simply won't work. 9DKR is leaving the gang to locate in Indiana. 9AOG is in California. 9AYQ's wave is exactly 183 meters, but has been too busy to ham much. 9EGF is doing very good work, handling lots of traffic on schedules. He has schedules with 9EGU and e4DW. He tried to put his set in a beer case to give it more kick, but ND. 9CMS is working on a constant frequency system, without a crystal, but as yet has not completed the installation. 9BJD is a new station and a good one. 9DFD finished school and will be with us regularly. 9KV and 9CKI, active ORS in Duluth, both report work as good and shoved through a few messages. 9CDV is doing fine work,

leading in traffic with 209 messages. Three operators were on duty during the Xmas vacation and worked Canal Zone 99X. This is a break-in station now—attention other BK-Ins!

Dist. No. 2: The RI visited Northfield with the result that 9BMT lost his license because his station was not at the address specified on the license. 9CXE's license was cancelled for using straight A. C. on the plate on the 40-meter band. The others were ordered to observe quiet hours. 9DBW tried to co-operate with the BCLs and the result was a bruised hip when he fell off the roof while putting up a "key-click catcher" (?). 9ANJ has located his QRM in a power leak, and now works out fine on 80. 9AIR is experimenting with manufacturing crystals. He has succeeded in forming several fair samples, although unable to make them oscillate yet. His best one melted when he tried to hasten the drying in an oven. 9COF finds it is impossible to work on 40. 9BNF worked NIS 1100 miles east of New York, and was reported R6. "BNF" is one of the famous low-power wizz's in Minnesota. 9SF put in a 400 foot receiving antenna and likes it fine. 9EBC still does fine work on the 80 band. 9MF operates at 9XI during the week, and at his own station whenever he has a chance. 9BCN has been receiving cards from South American and England. 9MB has been stepping out to Australia nicely and does fine daylight work. 9EHO lost his fiver, and is waiting for a German 80 watter. 9DDB is still on the high waves. 9EFD is also on high waves and worked good DX with a 201A. 9DMA bounces over to the east coast easily in the afternoon. 9CPO holds first place for hard luck this month, having blown his 50 watter, two 201A's and a 40 henry choke, but is on with a Ux210.

Dist. No. 3: 9BVH worked BZ5AB, R-AA', F8WW, and 99X, but power leak is so bad that operating is impossible most of the time. His 400 foot antenna and ERLA 1000 cycle transformer work much better than the usual equipment. His crystal controlled transmitter refuses to perk yet, but "where there is life there is hope." 9CRZ and 9CUM use 230 volts B bats on the plate and work both coasts with ease on 80. 9CVC installed the 4 coil Meissner circuit, with wonderful results using a 5 watter. 5PH is another enthusiastic user of a long receiving antenna, and reports foreign stations coming in fine. He uses the 4 coil Meissner circuit with equal good results. 9APE is coming down to 40 using a UX210 and a 50 watter in a M. O. 9BMX logged 19 countries using 2 199 tubes and a 50 foot antenna. 9DPX uses a new DeForest "H" tube and is rebuilding to the 4 coil Meissner. 9DYZ is on 40 and works the west coast up to 10 AM. 9BPY is kept busy at school and finds little time to be on the air. 9GH uses a UX210 with 150 watts input, on 40, and works all over. 9XI is in active operation, doing wonderful work as usual, and setting an enviable record in working foreigners, consistently. 9SE sets another high mark in traffic for this month, with 913 messages. He has DX ability as well as traffic ability, as is shown by his being heard in New Zealand at 4.37 PM. 9ZT continues to be heard in more countries, as well as working more and more. He heard A-8BD in the afternoon. 9ELJ and 9DWO are keeping right up on traffic. 9BIS is off the air for a short time. 9CZQ is pounding brass at 9XI. 9GPM is off the air until he gets his new tubes, waiting for an "H" tube and a 204A. 9DDP will be off the air for a while. 9ABK found that he could operate his set at much greater efficiency with a grid milliammeter in circuit, so the grid current could be watched and the set adjusted to a finer degree. With an input of 24 watts, he worked 138 stations in 3 weeks.

Traffic: 9EGU 84, 9CMS 4, 9DGF 56, 9EEP 8, 9DKR 11, 9CKI 14, 9DV 29, 9BJD 6, 9DWN 4, 9CDV 209, 9ANJ 4, 9COF 2, 9CPO 19, 9DMA 15, 9EBC 27, 9EGG 1, 9MB 4, 9MF 2, 9SF 4, 9DDB 2, 9DBW 59, 9BCN 13, 9BIY 47, 9EHO 8, 9AIR 5, 9BNF 39, 9CUM 50, 9BVH 5, 9CRZ 16, 9BMX 6, 9CYZ 2, 9DPX 15, 9BPY 24, 9PH 23, 9IG 11, 9SE 913, 9XI 13, 9ABK 104, 9DDP 10, 9DWO 9, 9ELJ & 9BXV 11, 9ZT 32, 9BNK 41, 9DAO 10, 9GH 6, 9BTT 18.

DELTA DIVISION

B. F. Painter, Manager

THE honor station for this month is 5ARB of Meridian. He receives two silver stars as he had the greatest originated traffic and the greatest total traffic.

QST FOR MARCH, 1926

ARKANSAS—Little Rock—Harry Freese was appointed City Manager. 5ABI has been handling good traffic during the noon hour. 5QH is on 80 working out well. 5AIP is also on 80. 5AQN is on 40. 5ANN is still QRW but gets on now and then. 5ABI has moved to Conway. 5HN has a junior op. 5ARB has been on very little. 5CR will be back shortly. 5AW is having trouble with both transmitter and receiver. 5AQX reports increasing activities and rebuilding.

Traffic: 5ABI 20, 5QH 18, 5AIP 13, 5AGN 2.

MISSISSIPPI—Meridian—5AQU is having QRM for examinations. 5YD announced that they are out for the next Hoover cup. 5AGS is still waiting for his "H" tube and his big antenna is down so cannot work on 80. 5ARB is the big star station this month. He kept schedule with 6CAH and handled one death message. 5AKP blew an "S" tube and will be off until a new one arrives. 5QZ wants more traffic.

Traffic: 5FQ 2, 5AQU 4, 5YD 38, 5ANP 7, 5QZ 46, 5AKP 21, 5ARB 46, 5AGS 2.

LOUISIANA—Plaquemine—5ACY is rebuilding. He will be using a DeForest "H". 5KC is back home and expects to be on shortly.

NEW ORLEANS—5QJ worked 2APD who was using a 2UV-201As with 90 volts. 5MQ is heard on the occasionally, with one of the new "H" tubes. 5GI seems to have given up. 5UK was QSO C4DE, who gave him a message to the advance agent of a motor party leaving Winnipeg headed for New Orleans. This advance agent, Mr. Bruce Boreham, was located here on his arrival and he promises to have the motor party advised of the facilities offered them by the amateur fir the sending back home of friendly messages. This should help the traffic total for next month's report. The main points that they will stop while in the Delta division have been well covered and they will find that they can be QSO home where ever they stop.

SHREVEPORT—5ML is still on 180 with phone. 5AGJ and 5ANC plan to consolidate stations. 5WY found a little time to get on the air.

Traffic: 5ACY 6, 5AGJ 3, 5WY 5, 5EC 1, 5UK 7, 5QJ 30.

TENNESSEE—Memphis—Activities here are on the increase. 4DK made his first report last month and followed it up this month. He uses a UX 210 on 40. 4IV is busy graduating and trying to use a 250 watter at the same time. 4HL and 4FA are new stations. 4EO reports traffic and good DX, having been heard in England on low power on 40. 4CU continues to be the star station in Memphis. Last month he clipped off 74 messages and 33 this month besides working on schedule with 5WK and b21AF. 4FL is heard occasionally and we wonder what has happened to 4KB. 4FW has a 250.

BEMIS—4KM has been pursued by the YLs of late and the station has suffered badly but it's all over now.

Traffic: 4DX 8, 4IV 8, 4EO 9, 4CU 38, 4FW 16.

HUDSON DIVISION

E. M. Glaser, Mgr.

TRAFFIC has taken a jump and many new stations are reporting. 2GDH grabs the honors with 249 handled. 2AHK, 2BL, 2AFV and 2CYX all had over 100 but not a single station sent his messages to the DM for checking. They cannot be counted in for the traffic trophy unless they are checked by the DM. It is well to note all these stations are ORS except 2BL.

Fellows, let's begin a campaign for faster and more accurate operating. Instead of sending 10 words a minute double, let's send 15 single for a starter. To do this, you must have a STEADY SIGNAL AND A GOOD NOTE. Consequently, work toward that end. Later, we will publish a list of the stations that can be RELIED UPON to take traffic at 20 wpm single. Of course, most of these stations will be ORS, but there are some darn good ops who haven't ORS and there are many ORS who don't know much about operating. We want to make ORS out of the former type and get after the latter to improve their operating. A station you are working reports you R8 and steady, and when you tell him QTC QRVT, he loses you or doesn't bother coming back. Fellows, it's THOSE BIRDS THAT WE WANT TO GET RID OF. They don't deserve to be allowed to hook an oscillator to an antenna. Keep a log of those fellows and have the "black list" handy so that you don't

QSO them any more. If we all work towards that end, we can get rid of a lot of obstructions to our fun. What say?

The Army work is coming along, slowly. The New York National Guard is bucking the plan and making a lot of trouble. If you have sent in an application for this work, it is on file in the DM's office. Please don't keep writing and asking about your appointment. That will be taken care of as soon as possible. Of course, it is obvious that all stations requesting appointments cannot be appointed. There aren't enough units. If anyone has any useful suggestions of any kind along the traffic line, please drop a line to the DM.

NEW YORK CITY—Bronx—2CYX leads in traffic and is doing some fine DX. He is QSO SMYX at 4:20 PM and has worked three G's and two BZ's in an hour and a half. 2ALL has requested an ORS. 2APJ burned out an H tube and is now using a 201A. 2APV is one of the country's best DXers. 2BBX is still working 'em all with his liver. Worked KPL and HU 6DBL. 2BQL is going back to the slop cells after fooling around with S tubes. 2FF with two ops, is a new station to report.

BROOKLYN—The CM is getting busy and planning to re-organize the boro and get a lot of new stations to report. 2CTY is doing the best DX and relay work at present. 2WC is getting fine results with his crystal transmitter on 84.15. 2PF is QRW club and college work. He uses a break-in system that works FB. 2KU has a schedule with 6CCU. 2BO is going strong. 2BRB is QRW with EXAMS, Army Work, many new ORS appointments and other ARRL work, and the YL, and isn't on the air much I G. M. Smith Jr., the 2nd op at 2BRB, is now president of the Radio Club of Brooklyn and has so much other work, he never pushes the key. 2X2K wiggles the bug once in a while. The Radio Club gave a very successful "fancy dress ball." You should have seen 2UD and a few others. Doc. Dunn is doing nothing much but experimenting at 2CIA. He is very QRW with Division work of various kinds, of which you shall hear next month in QST.

MANHATTAN—We congratulate the CM, 2CHK, for the excellent report which is getting to be a habit with him. 2CVL and 2AWQ reported out of their districts. 2LD is QSO Europe all the time. 2KR worked the West Coast and Europe with a 9 foot wire on the ceiling. 2EV worked Panama and took a bunch of traffic. 2ALS is putting the 50 on 80 and an H tube on 40. 2BNL has worked a few 6's lately. 2CZR is doing the usual work. 2CHK has a few evening and morning schedules 2HJ, City College, has a new chief op in 2AOF who will see that the operating side is well taken care of. 2FK, Columbia and 2CCL, N. Y. U. are going strong.

QUEENS—2RB's ORS has been cancelled for not reporting. 2AEP is doing most all the work. 2BSL is seldom on. A few stations in Astoria and Hollis are going strong and should be a great help to this slow boro.

RICHMOND—Activity is steadily on the increase. 2CEP, 2CEV, 2AKK, 2AYO, 2ACZ, 2CZLN, 2BQM, 2AFV, 2GE and 2AMO are on the air keeping things humming. 2LAKR is using slop jars with 700 volts. 2AKK has a new aerial that works FB. 2ACZ moved his outfit to the new power station, 2AYO. 2CEV has given up ship work for a while. 2CEP has no luck on 20. 2AFV handles most the traffic for the boro as usual. 2CZLN works 6's on his liver. 2AMO is an ole timer. Ex10CEC is now signing 2GR.

Traffic: 2CYX 103, 2ALL 11, 2APJ 7, 2APV 48, 2BBX 39, 2BQJ, 35, 2FF 14, 2CVL 15, 2AWQ 21, 2KU 53, 2BRB 20, 2BO 16, 2WC 29, 2CTY 86, 2AOF 10, 2PF 6, 2CHK 8, 2LD 14, 2AMJ 29, 2KW 2, 2KR 14, 2EV 44, 2ALS 5, 2BNL 7, 2FK 25, 2CZR 14, 2CHU 50, 2LM 47, 2BUI 4, 2BHY 12, 2AEP 34, 2BSL 2, 2AFV 116, 2ACZ 86, 2AKR 34, 2AKK 28, 2CZLN 88, 2AMO 29, 2CEV 6, 2CEP 67.

EASTERN NEW YORK—ADM, 2PV—Dist. No. 1: 2AV says what he needs is a husky kick so has been closed down for the month rebuilding. 2GY is still experimenting on low power and worked 9CCQ on .04 watts input. They also keep schedules with 8ZE, 9CCQ, 9CM, 9ECC. 2AIZ still keeps schedule with 2CKG at sea, but says if 2CKG's YLs would move to Locust Valley, he would get more traffic for them. 2AJE is now an ORS and also turned in a good total. 2CLG has been off the air for two weeks moving his station. 2BPB has been keeping schedule with MIT.

2KX has been very busy of late and is very sorry that he has not been able to answer each report from the gang who are supporting him in fine shape.

Dist. No. 2: 2AAN has finally got a 50 and works ASBM, IIRM, R8EU and 2ADH! 2AJQ works the coast with his big German bottle. He is hard put for an antenna. 2ADH worked into Kansas just using five turns of R. C. A. inductance for an oscillation coil with 15 watts input. 2CTF was heard in Samoa on 80. The Goetz Bros. don't find much time to operate the set and say their Hardware Bizz is to blame. The DS says it's Bertha and Evelyn! 4UC, the former president of the Yonkers Radio Club, was back in town from Florida with his YL. 2AAN says their all as "nice" down there. 2ADD says marriage and radio are the antipodes of Life. 2AG is on 40 and 80 and has a new one he calls a "wobbler."

WHITE PLAINS—2BQB seems to have let the YLs inelegible him away again, or is it school QRM? 2AAZ blew another 5'er and bought a 95% 201A that seems to have the right stuff in it. He reports QRM from school exams. 2CNS makes a specialty of "round trip" msgs. It seems. He had one for Atlanta so raised 4RM and had him get an answer back inside of five minutes. 2AI and 2AML are new stations. 2LA is set at last with two 5 watters, on 170. 2BSA should drop the DS a line on what's going on. 2NW worked Holland and seems to be getting out real well with his 50. 2APT worked into the Canal Zone with a lone liver. 2APQ hasn't his set working yet as he hasn't much time. The DS wants to remind the gang that his ADX is Box 113, Yonkers, and although other ADX are OK, the mail takes a day longer to arrive.

Dist. No. 3: 2CDH is doing some fine ttc work. 2CYH hung up a shingle and boosted his ttc quite a bit. 2AGM had bad luck again. The armature of his generator has burned out again making three times in as many months. 2SZ was not operated during the holiday vacations so of course, traffic was low. 2ANV is stepping out in good style having worked all districts except 6th and 7th. 2ANM is so busy getting dope about other stations that he forgot to send in some dope on his own.

Dist. No. 4: 2AKH is still pounding out the traffic with the biggest total yet. 2COV got hold of a good plate transformer at last and is doing good work. 2AUO is very QRW but is on some. 2CYM has his set going at his new QRA and is stepping out fb on 80. 2AOX has his transmitter down to 40 and is doing some fine DX. 2AGQ handled a lot of foreign traffic last month. 2MK is on 40 now and is working DX all over the globe.

Dist. No. 5: We have a new DS in this district and the ADM hopes that all ops will give him their best co-operation. The new DS is 2ADM. 2CGH is putting in a UV 203A with hopes of raising a few of the 6's and 7's he hears. 2CGJ is not on very much but is working good European DX. 2CAZ, "the five watt man" is our youngest op. 2ACS is working fine DX with a UV203A. His best so far is X2BG in India. 2ADM is temporarily off due to a wrecked mast. 2BSB just got started with a fifty and is in hopes of doing some good DX on 40. 2AWF is getting a little more spare time to pound the key. 2PV worked Europe again this past month and is now on the lookout for an A, Z or BZ to come back to him.

Traffic: 2AIZ 74, 2GY 33, 2BPB 2, 2CLG 8, 2AJE 71, 2KX 24, 2AAN 10, 2AAZ 12, 2ADH 5, 2AJQ 11, 2APT 80, 2CNS 22, 2CTF 11, 2DD 1, 2LA 2, 2CDH 249, 2SZ 1, 2CYH 48, 2AGM 1, 2ANV 6, 2ANM 24, 2AHK 148, 2COV 6, 2AGQ 84, 2AGJ 5, 2CGH 4, 2CAZ 22, 2ACS 4, 2ADM 79, 2AWF 6, 2PV 1.

NORTHERN NEW JERSEY—2ADU works the West coast with an indoor antenna. Unofficially we hear that 2AWT has moved and is quitting the ranks. 2CXE and 2AJA were very active during the Xmas vacation and have returned again to college. 2CGB cannot make his new transmitter oscillate on the low waves so remains on the higher ones. 2CVF is burning the midnight oil in his new Chevie coupe with YLs. 2CJX cannot get the kick out of 40 that he had in the old spark days. 2WR is QRW selling Radiola's by the car load with a Newark jobber. 2CO and 2AXF are using their amateur knowledge in the BCL game at Radio Service. 2CW, desires an ORS. 2AOB lost his licenses in the mail and must remain off the air for a few weeks. 2ABZ is QSO the entire states with a 201A with storage battery plate supply. 2BWW has returned to the air and is very active. 2AWL now owns and operates WJBI. 2AHK is doing

excellent work on short waves with low power. 2BW was heard in Alaska in daylight with 80 watts input. 2CY has a junior operator and is anxious for schedules on 80. 2BBH has encountered trouble on 40. 2CRP quotes DX as being pretty good. 2BIR worked 13 countries with a 50 watt with 60 watts input. 2ZB requests all Newark amateurs to report on time. 2EY could not dig out any traffic. 2API has been elected Chief op for 1926 at 2JC, the Bloomfield Radio Club. 2CKY threatens to burst forth with a 500 watt fone on 80, deserting 40 CW work! 2BL at Como with a Hertz antenna on 40, pushes 3 amperes into the antenna with a 250 and is QSO the world. 2CGK is still laid up with his leg in a plaster cast due to a serious accident. 2BUY is the DX fiend of Dist. 4 on 38. 2FC is QSO England and France but has trouble collecting traffic. 2AUH is trying out a Hertz antenna and worked Swedish SMZS. 2BGI is still working Australia besides helping 2ADV get on the air. 2DX has a new transmitter but business pressure keeps same silent. 2AEY is returning to 40 and has constructed a real receiver. 2AGI is using a 50 on 80. 2AAW installed a new 250 watt which proved defective. 2CQZ can be heard daily on 170 for traffic and 40 for DX work. 2AMB is playing with master oscillators for the Army Work. In addition, 2AMB is training a few men to be operators of his new station.

Traffic: 2DX 14, 2AEY 23, 2QS 15, 2CQZ 12, 2AMB 22.

MIDWEST DIVISION P. H. Quinby, Manager

THE men of this division are to be congratulated on the excellence of the reports for this month.

Very few did not report and the thing as a whole shows accomplishment. As you all know, it is impossible for your officers to make a complete and interesting report, unless you furnish them with the necessary information and material. And when you do this, you can see for yourself what is accomplished. If you are in the habit of reporting regularly and on time, and do not see your call mentioned on these pages, something is wrong and you should notify your division manager direct. He has just discovered one or two such cases and corrected them. It takes some time for the reports to go thru the hands of a CM, a DS, an ADM, a DM and on to the TM.

KANSAS—Dist. No. 1: 9KM is doing fine traffic relaying with 9BVN coming second. 9BVN is very QRW keeping WDAF going. 9DNG will be using a new 250 instead of the 50. He worked 25 countries and was heard in four more. 9AOD doesn't get on as much as he would like to. 9EHT reports a new station in Lawrence. 9CVL has been doing some fine DX on a fiver and is tuning up a new DeForest tube. 9AEY added Bermuda and M-9A to his DX wkld. He reports that 9CCV and 9CLE have combined and have a 40 meter CW and a Phone and IGW on 175. 9DBH worked CH2LD and reports traffic plenty. 9CFT reports his remodeled station getting out in fine shape. He has a phone on 185. 9QW and 9ACQ QRW school.

Dist. No. 2: 9BRD gets lots of comments on his cards. He kept schedule with C-410. The new DS proved to be a false alarm so please report to the ADM direct after this. 9CCS was QSO 90-A6N and when through with him, he raised Z-3AD. A new transmitter for 80 is on the air.

Traffic: 9EHT 5, 9KM 80, 9RVN 10, 9DBH 31, 9AEY 36, 9CFI 4, 9BRD 6, 9CCS 7.

MISSOURI—Quite a number of dormant stations came to life and there are also few new stations reporting.

Dist. No. 1: Traffic is about the same as last month per station but more stations reported and an increase was reported by some. 9BEQ is testing a small cage against his regular aerial. 9PW and 9BEQ are still combined the POW has been heard on the air by the ADM. 9AOT has an H tube and says it works OK, with 3000 volts. 9ZK-AU is still working tfe and DX with both sets. 9DXN was obliged to QRT due to sickness of his father. 9DLB is on in lapses of biz QRM.

Dist. No. 2: Ex-9DZO is back signing 9CWZ with 203A and S tubes. 9EBY is quitting 40 and going to the S. W. fone band with 150 w. 9AYK handled the usual traffic. 9DOO is on again with 5 watt. 9ADC is on after moving. 9UI is working a new WE 50. 9DAD is using a WE 250 on 40 and 20 and has

built a new transmitter and receiver entirely glass insulated. 9EAO rebuilt the works entirely. 9BRU has a new 50, and used it to advantage in traffic. 9CYK blew his spot welded 50 (hi) and QRT. 9DNJ keeps schedules at 12.40 pm daily with 9UA, 9BYQ and 9DCD. He handled a stored car report and worked 5FH in daylight. Opr BD of 9CK visited 9DIX Xmas and boiled owl stuff was enjoyed. 9CDF reports power QRM bad in Butler. 9AJW has 10 watts and says several more stations in Joplin about ready to shoot. He handled a QRR message, and keeps reports loose coupling bettered his DX. 9DAE is same 201A but replaced MG with CRAC 24 jars and schedules with 9BFG 3 times a week. 9DVF uses QRX having taken receiver to the country and can't get it back again. 9AOB blew the 250 and is temporarily pounding the brass at 9DTA. 9CYM broke into the msg figures. 9AOB's antenna was cut twice by BCL's, his 250 blew and his house was damaged by fire. Pass the hard luck trophy to 9AOB. 9CRM blew the plate supply and has been QRT. 9AVS is still waiting for power supply. 9CHE is on 40 handling traffic and worked NZ and Australia. 9BUE has an X now—9XV. Ex-9CHJ reports still QRW with school. 9AJW applies for ORS.

Dist. No. 3: 9EEH continues traffic handling and is applying for ORS. 9DWK was inactive except for OBS schedules. 9BDS is coming on shortly. 9BSH reported ND this month. Hamfest was held at 9BSH. More interest was shown than for some time past. 9BOB ex USN is on at Sikeston. Has been heard often at the ADM station. 9CZI is a new station at Charleston with an H tube.

Dist. No. 4: 9RR handled the most traffic. 9ELT was second but had QRM from school. 9ADR and 9BKK were next. 9BKK keeps up ham news in the KC Journal. 9ACX is now QSO NZ with a 210. 9WV is on regularly on high waves. 9BKO is again handling traffic on 80. 9ACA is a new 80 meter station using 201A tubes but has worked 800 miles during the first week. Ex-9CXO signs 9AYT after 2 years' absence. 9AZL visited the hams of KC recently. 9AHU is a new ham. 9ZD is gunning for off wave hams on 40. He reports working 20 meter stations often on the harmonic of his 40 meter set and says he does not need a 20 meter transmitter. Hi. 9CZW led in traffic. 9EEZ and 9RND following. 9BND reports the H tube worked OK on 180 meters. 9CZW is getting a 50. 9EEZ uses a 210 and worked HU6AFF the first night. 9FF is on again with his DC jug. 9BDB is a newcomer.

Traffic: 9ZK 83, 9BEQ 60, 9BHI 26, 9AOT 32, 9DLB 4, 9CHE 19, 9CEZ 5, 9EBY 7, 9AYK 20, 9DAD 5, 9EAO 1, 9BRU 12, 9CYK 12, 9DNJ 20, 9DIX 30, 9CDE 34, 9AJW 83, 9DVF 30, 9DTA 18, 9CYM 10, 9CRM 139, 9BUE 7, 9EEH 30, 9BKK 33, 9DVU 12, 9RE 164, 9ADR 43, 9ELT 118, 9DBE 2, 9ACX 12, 9ZD 17, 9AHU 15, 9ACA 2.

IOWA—9BKV is high traffic man handling 266 msgs. He is on 75.5 meters and makes his high total by having reliable routes in all directions. 9DOA rates second with 145, and 9CZC with 140. 9CZC's msgs consisted of XMAS greetings. He has several routes working fine. 9BOS is on occasionally but has had some antenna trouble. 9AED says 40 is ng for tfe so has changed to 75 where he can handle tfe. 9BPF, one of the ops at 9LC was on the air during Xmas vacation and handled tfe from his own sin. 9DMS is on in the early morning. 9BDH is a well known and is an Army station situated at HQTRS, Troop 14th Cavalry at Ft. Des Moines. They are now operating on 80 20 and 40. 9AXD now has 100 watts DC on 41 and expects to be on the air regularly. 9BCD has been very busy with business the past month. 9HK relayed 14 this month, and is building a 5 watt set with power supplied by a 12 v—receiver, using a 201A tube. 9DOA has made the Brass Pounders' League. All his tfe was handled on 85. Schedules were kept with 9BGE, 9DXY and 9ASJ on Mon, Wed, and Friday. His transmitter is a CH with S. tube RAC 600 volts on 2 5 watt tubes. He also reports a new ham at Tipton. 9DLR. 9CGY is looking for schedules on 150 to 200 meter band. 9DJA handled 5 msgs and had a schedule with 5AWL. 9CXC has his transmitter on 37.5 and his DX was Australia, N. Z., and S. America. Schedules were kept with BZ-1AB. He handled tfe from "Antarctic AQE" sent to him by KFUH at New Zealand. He is using 20 for QSO S. America with the help of BZ1AB and BZ1AC. 9CS has a 50 on the air. Best DX is Cuba and heard in P. R. 9CWG is on 40 and 80 and has been experimenting on 20. 9DSL is on

40 and 80 and his best DX is Cuba. 9EES reports working Chile and is operating on 20, 40 and 80. 9BVR, ex 3PZ-3XO, is on 37.52 and is using the 3XO circuit. 9EBX, 9EV, 9ACH, 9BVR and 9BZI made application for ORS. 9BZI is on the air with 250 watts on 40 and 80 and has worked NZ, Australia, Mexico and England. Two ops work the station every day at noon and every night from 10 or 10.30 to sunrise.

Traffic: 9BKV 266, 9DOA 145, 9CZC 140, 9BOS 21, 9BPF 27, 9AED 5, 9DMS 15, 9EKK 8, 9BDH 9, 9EFS 45, 9BVR 14, 9AXD 4, 9HK 14, 9DAU 79, 9DJA 5, 9CXX 2, 9CS 8, 9CWG 1, 9DSL 12.

NEBRASKA—Dist. No. 1: Reports for this month show that activity is at a peak in this state—DX is good and traffic totals are climbing. 9BFG chalked up a new total. His schedules number ten and it takes five hours of operating every night to keep them. He finds plenty of traffic. 9AWS is arranging a number of schedules. 9NL lists Mexico as his best DX this month. He also received a QSL from N. Z. 9DUO and 9BYG report no activity. 9DR is heard quite regularly and this accounts for the report from 9BYG who is operating at 9DR. 9CGS will be on soon. Two fivers in a self-rectified circuit this time. 9DPS has been quiet this month. 9DUH is having hard time to get the plate supply he wants, but is heard quite often. 9DRY seems to be doing good work. 9GQ had the hard luck to have his station broken into and the complete equipment taken away. This isn't the first time, but it's all gone this time. 9AL was heard again this month. 9RGK has been QRW to be on the air. Other local Omaha stations heard occasionally this month were 9FA, 9BQF and 9EES. A good report was turned in by 9EBL and 9CDB of Lewellen, Nebr. They are trying two transmitters so they can occupy more of the bands. 9DXY looks like he will be in the Brass Pounders' League again. His 18 schedules a week are working to perfection. 9CJT is also on again and hopes to have some traffic.

Dist. No. 2: New stations reporting this month, 9AML and 9CEN both of Blue Springs, Nebr. Ex-9AML is now 9MU. 9CGQ is on regular now and has best traffic report this month. 9BOQ has been off due to sickness in family. 9PN says everything is fine but traffic. 9ALT is another regular now. 9ANY has secured a new tube so he should be heard soon. EX 9ABC, now 9BOC, at Phoenix, follows the Lincoln gang through traffic reports. 9ATL operated a 10 watt fone while home on his vacation and had some good results. 9QY is using home-made power and the Lincoln gang says he sounds like local. 9EAK tried some fone but got disgusted and went back to 80. 9DI is a regular and carries some wallop.

Traffic: 9BNU 7, 9EAK 4, 9CEN 4, 9AKS 7, 9CGQ 86, 9DAC 12, 9BFG 367, 9NL 24, 9AWS 29, 9DXY 260, 9EBL-CDB 196.

NEW ENGLAND DIVISION T. F. Cushing, Manager

ALL New England Division Hams should plan now to attend the New England Division Convention, being held at Providence, Rhode Island, April 9th and 10th. Rhode Island is the smallest state in the New England Division, but their promise is the "biggest time in New England". You should read this in the March issue of QST, and that gives you about thirty days to save up the necessary coin and make arrangements. Let's make this a bigger and better convention and show the Providence boys that we are with them to the last ditch. 1AOQ, 1BEB, 1AVZ, 1ACJ, 1AID and 1UU have been appointed ORS. Maine ORS and others interested will please note that Sidney B. Coleman, 1UU, has been appointed ADM for Maine. All traffic matters relative to that state should be addressed to him.

MAINE—The local traffic situation confronts us as a serious problem here in Maine. We have many active ORS on both 80 and 40 but it seems next to impossible to get traffic through East and West within the State. The difficulty is not with the signals. A little time spent in perusing the ether during the afternoon and evening will give a well distributed list of local calls heard. In order that some definite plan may be made for an intra-state test, the ADM requests that each ORS in the State make a log of all Maine stations heard, or worked within the next month. This dope will give us an idea of when stations are on, wave, and what parts of the state each is QSO.

Send the log along with your next regular report. 1EF is working at Noyes Lumber Camp, Deer Isle, Maine. 1OR blew out a 50 watter, but is going strong again with three operators. 1BDH is only home week-ends and vacations so is unable to keep any regular schedules.

Traffic: 1BDH 5, 1OR 10, 1BDB 10, 1EF 10, 1AAV 8, 1AYJ 27, 1BNL 88, 1BUB 26, 1VF 5, 1UU 27.

WESTERN MASS.—Dist. No. 3—1AMZ is in line for an ORS and is handling loads of traffic. 1XU has charge of automobile registration in Pittsfield and the BGL's never complain of QRM from his station. During the past month, 1ARE had quite a number of visitors Headquarters' gang in the form of Mr. Herbert and Mr. Handy were up over one week-end and spoke to the gang and pounded brass from 1ARE all night. 1UW was another visitor at 1ARE. We are all wondering if 1VC's transformer will ever be repaired now that the YL's have taken hold of him. 1CLN is completing the installation of DF7 at the State Armory. 1CKE is using phone. 1CEK has a nifty new transmitter.

Dist. No. 4—1BSJ has worked some good DX using a British receiving tube. 1AWW has been ill for a few weeks. 1BLU lost his 80' stick and he's rather handicapped. 1PY reports difficulty in getting his "H" tube perking. 1BVR sends in a nice list of stations heard and worked. 1AWW and 1APL were tie for traffic honors in this district. 1APL is reaching out fine with spark coil plate supply. 1AAC is on again with a 201A and 180 volts B.

Dist. No. 5—1BIZ has been working on 20 some, but uses 37 for his best work. Wonder what 1KC will do now that he has worked or been heard in all civilized countries. 1AKL has installed a motor generator. 1IP is at Annapolis.

Dist. No. 6—1AOF gets a nice Xmas present by clicking with a 5BG. 1BC, 1BOM is practicing ski jumping for the winter sports carnival. 1BNW has installed a new 2ync rectifier.

Dist. No. 7—1AKZ is using 2 UX210's and is QSO Australia. 1BIP is on when school work permits. 1ASU is pushing out fairly well with a DeForest tube. 1AQM expects to be on the air in a week. 1DB is the new Dist. Supt. for District No. 7, Mass. 1XZ has a couple of beautiful sticks. 1BDP and 1AFY are now on the 40 band. 1AAL has a nifty lay-out in his new location with a special room for his station.

Traffic: 1AAL 56, 1BIP 11, 1DB 26, 1ASU 15, 1AKZ 28, 1XZ 8, 1BBP 6, 1AAC 2, 1VU 2, 1EO 17, 1APL 37, 1IL 24, 1AWW 37, 1BLU 5, 1PY 4, 1BVR 1, 1CRZ 6, 1AAE 36, 1AMZ 65, 1AE 25, 1CLN 9.

EASTERN MASS.—Dist. No. 1—1CJD is on the S. S. Northland running out of Key West so won't be on before May at the earliest. 1CJR has QSY'd to 40 and is getting out in good shape with a Hertz antenna and circuit. 1ACJ has gone down to 80 and hopes to handle more traffic. 1BBK would like a schedule with a station in Boston on 80. 1LM is on again using two VT2's on 80.

Dist. No. 2—1YC has received the first Army Amateur certificate to be issued in the United States. There have not been as many enlistments as there should be. 1AIR is on again. 1AVY is getting out fb but says there is a lack of traffic on 40, it's all on 80. 1GA doesn't agree with him. 1AYX is now on 41 and back to stay. 1SE is making a lot of noise, he and 1NT seem to have trouble getting a dc note. 1ACI is getting out as usual. 1AHL is getting reports of crystal control D.C. 1UW works DX when home. 1ADM is QRW college but manages to work 6's occasionally. 1RF has been reported in N.Z. on 5 watts. 1CPQ is QRW college. With his faithful river, 1BVL worked F-8AIX in Algiers. 1BAT QSO'd with a 6, with his 5 watter using 550 volts on the plate. 1SL is on 40 and 80. 1OU is installing a new antenna and rebuilding. 1AVF is trying a Hertz antenna. 1CH still continues to work DX. 1BCN put up a new counterpoise but his family doesn't like the looks of it. 1ABA is on with 301A with 180 volts "B" battery. 1GA still continues to be heard round the world, he was QSO G-2SZ on 20, with an input of 50 watts. 1ALP is getting out on 40 and 20.

Traffic: 1BGH 19, 1CJR 20, 1LM 14, 1KY 37, 1JL 41, 1ACJ 3, 1BBK 48, 1ZW 3, 1ALP 18, 1ABA 17, 1AYX 1, 1AIR 11, 1AHL 6, 1ADM 3, 1AVF 10, 1ACI 40, 1AVY 31, 1BVL 12, 1BCN 12, 1BAT 19, 1CH 21, 1CPQ 17, 1GA 27, 1NT 7, 1OU 12, 1RF 12, 1SL 21, 1SE 13, 1UW 7, 1YC 145.

VERMONT—Dist. No. 1—Wow, but 1YD is sure off in a cloud of dust, turning in a message report of 91. 1AVZ and 1BEB have just been appointed ORS. 1BDX reports the transmitter rebuilt and will

run on a lone 50 watt. The ADM wishes to request the above stations to please report to the DS by the 17th of each month.

Dist. No. 2—1FN had the misfortune to burn out his 50 watt and the good luck to have a new Junior Operator arrive. 1AC is on the air, QRH 80. 1CQM returned to Rensselaer Polytechnic Institute. 1APU is the first station to get an Army appointment in this district. 1LA is in Florida. 1B1Q is at Woodstock High School and not on the air as yet. 1AJG reports New Zealand added to his DX list. The ADM wants the ORS to QSL him regarding Army appointments. We have only one in the state and that is very poor co-operation.

Traffic: 1AJG 18, 1APU 9, 1AC 7.

NEW HAMPSHIRE—Messages are showing a remarkable increase this month with 1YB heading the list. 1ATJ placed a message box in the radio stores in his town with a notice to the effect that messages will be transmitted free and also ran an add in the daily paper and reports that he has secured a lot of messages in this manner. Another thing I desire to call attention to, is the failure of most all stations to enroll in the Army plan or the Naval Reserve. There is nothing about either of these plans that any station could not do. If you desire any information in regard to either plan, drop your ADM a card. 1BNK is back on the air again with a 50 on 38. 1ATJ reports that he finds more messages on 75.

Traffic: 1YB 528, 1BFT 245, 1ATJ 129, 1AVL 50, 1AOQ 47, 1BJF 26, 1BNK 12.

CONNECTICUT—At last we are getting back into our old time form and it is a real joy to give this report. Your ADM is pleased with the hearty response and is sure that the boys are working hard to put the old Nutmeg state where it belongs. 1AOX blew his 5 watt and now is using a 201A for his DX. 1AOS while home for the holidays worked 144 stations. 1AYR reports wrecking his nice new Oakland roadster a few days ago. Think he must have had his transmitter aboard. 1BGC reports working his usual DX at Italy and 1CTI hopes to as soon as his transformer arrives from the Acme Co. 1MY hasn't reported on working WAP yet, but did get as far as Brazil. 1BHM reports working Spanish EAR 9. 1IV has been working hard at Trinity but is planning on remodeling the works soon to be some real DX. 1QV has removed to Westerly and this leaves a gap to be filled. 1CBG, operated by his Dad, reports everything all set for traffic while he is away working as a commercial. 1ZL showed how a real set can reach out. He worked a ship at Trieste, Italy, by taking six messages for the States and sending one for Austria. 1ADW reports traffic good during the holidays. He and 1AEQ are trying to interest a couple of YLs in the code and are making progress. 1AXN reports activity is at the peak and sends in a report of much interest for his section. 1HJ apparently is reaching out by working New Zealand, Brazil, Australia, Italy, Finland, etc., with his famous fifty watt.

Traffic: 1HJ 72, 1BGC 13, 1AOX 121, 1CKP 46, 1AOS 72, 1BHM 54, 1CBG 10, 1MY 5, 1ZL 13, 1ADW 33, 1AXN 51, 1PE 62, 1AJO 45, 1BLF 4, 1ABN 14, 1BQQ 31.

RHODE ISLAND—Dist. No. 1—1AFO is banging away and has worked Italy this past month. 1AID is a new ORS and is an Army station. She is on 40 and doing good work. 1AWE has one of the new DeForest "H" tubes. 1ABP is back on the air again and has been heard in Finland. 1BCC is off the air just now but says that he will be on after he gets married, which will be soon. 1AEI is still getting out good on 40. 1CAB is still simmering along as usual. 1PB says that traffic is slow this month as everybody is going DX crazy. 1BHI is now located at R.I. State College and has the station with him. 1BPB is going full blast with a 250 watt. 1BIE is still on 40 and going strong. 1AHE is trying out a phone on 83-85 meter band. 1DP is also going to use phone on that band, and will use B battery plate supply.

Dist. No. 2—1AAP picked up a local msg for France and sent it direct. He is also digging up quite a bit of traffic from the R. I. State College. 1BVB got a bunch of local traffic thanks to several of the local merchants. 1CDS has got his 10 watt Master Oscillator set running and if it proved okay, he will replace the 5 watters with 50s. 1CIU is about to get under way again after a long absence.

Dist. No. 3—1AOA was presented with a 250 at Xmas and will have it producing a mighty racket on 40 soon. 1BQD has dropped to 40 and is having great success with DX.

Traffic: 1BQD 38, 1BIE 5, 1PB 9, 1AAP 30, 1CAB 3, 1AEI 30, 1ABP 12, 1AWE 77, 1AID 14, 1BVB 106, 1AFO 16.

NORTHWESTERN DIVISION

Everett Kick, Mgr.

THE past month's activities went over with a bang! One station made place in the Brass-pounders League with another a close second. DX was exceptionally good for number of the gang, of which 7DF wins the cake for being QSO BZ. R es CH.

WASHINGTON—The traffic total for the state exceeded more this month than any month for a year. Sure looks FB to know the time was taken up entirely by our ole friend sea-oue. 7OT leads the division in joining the BPL. 7UQ and 7FQ were close rivals. 7MZ, 7NL es 7VL did some very good work and rate ORS tickets. 7WQ and 7GY worked all dists. with 3 fivers. 7WA, 7AF, 7BJ, 7AHA, 7AGI, 7GE and 7AO-RL all report being QRW other than Ham radio. 7DF worked BZ-1AC, 2AF, 1AB es 2AB. CH-2LD, R-BA1, using a 204 at normal rating. He also hrd G. F. es Africa O station. 7AFJ is working FB using a 50. 7VV put up a new tower es antenna. 7VN expects to be on next month. 7PZ. QRW remodeling. 7EK is back es was QSO A es HU. 7DC, 7AG, 7EN, 7NS, 7NG, 7ADQ, and 7KU are on with 50 watters or H tubes. 7AIM is reconstructing. 7KO, 7WD and 7TG report traffic improving. 7JR is on the air, 7BY es 7ABF are on the job in Seattle. 7FD is on using a 201A. 7OY, the Seattle, CM, won't be able to pound brass for a while, as he has just been initiated into a Frat at the U. of W. The initiation lasted a week so the after effects will probably linger a while longer. 7UE is on with a 301A using B batts.

Traffic: 7OT 130, 7UQ 93, 7FQ 85, 7MZ 67, 7NL 61, 7VL 58, 7WQ 27, 7KO 27, 7VV 25, 7AO 24, 7WD 20, 7OY 19, 7AG 17, 7TG 14, 7BY 13, 7GY 12, 7EN 10, 7DF 9, 7JR 8, 7ABF 7, 7BJ 4, 7VN 4, 7NS 2, 7ADQ 2, 7NH 1, 7DC 1, 7EK 14.

OREGON—Only a partial report this month as the ADM is just getting lined up on activities etc. Portland is quite alive being represented by: 7AJB, 7AEK, 7LQ, 7ALK, 7IT, 7AV, 7JP, 7FE, 7EF, 7WU, 7ADM, 7VP, 7KI, 7GJ, 7VQ, 7JO and 7KY. 7AEK, 7IT, 7ALK and 7LQ are newly appointed ORS. The star station was 7AEK. He works out beautifully on his 208A. 7AJB and 7IT use the tuned plate es grid ckt and say its FB for stdy wave. 7LQ es 7AV both handled neat totals. 7LQ worked 45BT es a2YI, the latter being R5 receiver without aerial or ground. 7ALK has a tremendous signal but complains that he can't hear any Aussies or Zedders. 7KY is fast becoming a contortionist trying to find the node in his antenna so he can place his ant. meter and get more reading. 7ND will soon be back on the air. 7ADM is changing to tuned plate and grid ckt. 7WU has lots of trouble with the BCLs. 7VQ has worked PI on a 5'er. The plate starts to melt on the dashes but only white hot on dots. 7EF is a fine op altho nearly blind. 7UJ succeeded in QSOing BZ-1AB. 7EO moved his entire set out to his radio shack, it was formally remote control.

Traffic: 7AEK 38, 7AJB 21, 7LQ 15, 7AV 14, 7KY 8, 7FE 7, 7EF 37.

IDAHO—7JF blew one of his tubes. 7QC is still busy getting his DeForest bottle going. 7GW is working gud DX. 7PS is feeling cocky about being reported in the Canal zone. 7YA-XT is on occasionally and having trouble working DX. Loop modulated fone is being experimented with on 35 meters using 7XT. 7ZN es 7SI were back home during Xmas holidays. 7SI sez that the gang have not 4 gotten her judging from the number she worked while home. 7PJ is still using different antenna every night in effort to get one to suit him.

Traffic: 7QC 22, 7GW 8, 7JF 79, 7PJ 7.

MONTANA—Montana's message total looks a lot better this month. Conditions were very bad being the worst the ADM has had since '23 for QRM, QRN es QSS, the gang are congratulated for every message meant a fight to get it thru. 7DD deserves the ADM prize this month but its going to 7ACI because 7DD has already won his subscription. 7ACI only used an amplifier tube for his work but has an English 30 watt on the way. 7PU also used an amplifying tube but received his new UX210 just b4 sending in his report. 7FL has been recommended for ORS. 7MX got a fiver for Xmas. He has a new schedule for 76, 38 es 21. 7ZU lost a 50 but secured another. 7NT has been QRW office. 7GK reports an interesting trip to NSS. 7EL will be on 80 soon. 7BI sends regards to the gang from himself and OW. 7ZF will be on with a 50.

Traffic: 7DD 50, 7ACI 25, 7PU 17, 7FL 11, 7MX 10, 7ZU 7, 7NT 4.

ALASKA—The ADM contemplates moving to the states again for not agreeing with the climate any too well. The new ADM will be 7KN, Thomas Donohoe, Cordova who will resume where TDE leaves off. The gang have adopted their own intermediate being "AU." WXP at Fairbanks, uses 5 watts with MG plate supply on 83 meters is on every night from 10PM PST till early morning. 7SM is on 84 meters es QSO states. 7OE is getting out good on low power, QRH 82. TLT is handling lots of traffic. 7KN is on the air again. TDE is using B battery supply on a 5'er and gets same results as his over loaded 50.

PACIFIC DIVISION

Southern Section, L. E. Smith, Mgr.

THE new manager wishes to thank the fellows for the honor they have given him and promise to do his best to put the Southern Section on top. Due to this change, several new men have been appointed. W. S. Wiggins, 6CHZ, is now ADM of Dist. 1 and 2. Jack Barsby, 6BBV, is the new DS for Nr. 2 and Raymond Kridler, 6CSS, is the new CM for the Whittier section. Recently, about 60 of the gang attended another So. Section banquet held in Los Angeles. Mr. Babcock was present and problems concerning the section were discussed. Several interesting stunts were put on by different cities, featuring Charleston dancing, cracker eating, CQ contest, etc.

Dist. No. 1—Activity in this district was none too great this month but as San Diego has a bunch of new hams coming up, we will expect action in the future. 6AJM has a new DC generator and has been QSO Tasmania. 6ZE is practically off on account of power leaks in Mexico (1 mile away) which he cannot control. 6BQ, 6CGC and 6CHX have had various troubles but keep going at times. 6BDE claims that nite work keeps him away from his set. Sounds bad. (YL??) 6BAS has installed a 250. 6SB has schedules with 6RF for LA traffic FB, OM. (I wish there were more—SM).

DIST. No. 2—This district is growing rapidly and handles the majority of the traffic of the Pacific Divisions. 6BJX again leads with 568. Give him some competition, fellows. Another fone hound, 6AFG, on 80 now. 6BBV, the new DS, brags a new 20 ft pipe QSSless antenna. Schedules are kept with PI by 6BJX and 6BGQ while 6BJD has one with Hawaii. 6AE, OSW, DAI and RF have been thru various stages of rebuilding and claim more punch now. 6BCS stirred the ether from Shanghai to England. 6JI says that "Cheve" is FB except for bad brakes, noisy shift, bum lites and loose bearings. That's a good car! 6OF takes all honors for sheik stuff this season while 6VC runs a close second. 6CGV knocked 'em dead while home Xmas vacation. He sez 500 ft recvg antennas are FB. 6CAE is on the war path for traffic. Satisfy him OMS. 6DAA was QSO NGY, the USS Helena in China on 86. One of our new ORS, 6NW, reports working 5VM with .75 watts input. 6CTN is going to move away from his power leak. That's one way to get rid of it. OM. 6RN is after message records. 6BBQ has his Comm. ticket and is going to sea. 6CMQ bought an "H" tube but it arrived in "many pieces". Junior College is keeping BLS busy, the fellows in Oxnard complain of trouble from YLs and new cars. 6CDY is now operating BC atn KFVY. Santa Barbara comes to life again, 6AAK having worked So. Africa with a 7.6 watter. 6AJI is another low power hound, having worked PI-IAU with 16 watts input to a C901A. 6AKW keeps a schedule with 6BJX. College has been keeping the Whittier gang off the air but they are still alive as ever. 6AHP worked 5RQQ and AQE, a Norwegian Whaler, 71-31' Lat., 189 Long.

Dist. No. 3—Arizona is coming to life in great style and promises more activity than for many months. 6ANO is the new ADM there. He also leads in traffic. 6YB, 6XAW is on 40 meters now using 50 watts. They want schedules with other colleges. Many of the gang are using 5'ers, among these are 6ARX, 6RS, 6CAP & 6BTV. 6PZ complains of school QRM and 6GS claims the same trouble. 6CUW is running a "50" on 40 and is getting an "H" tube. 6BTV says his first five watters won't last over a week. 2000 volts?? 6BAH is doing low power work. 6BBH has a 40 meter portable broadcast station, 6XBH. 6BWS wants to hear from some of the gang who use low power on their junk.

Traffic: 6AE 4, 6AFG 7, 6BBV 14, 6BCS 39, 6BEV 9, 6BGC 26, 6BJD 12, 6BQR 14, 6CSW 27, 6DAI 37,

6IH 40, 6JI 17, 6OF 6, 6RF 7, 6CIX 6, 6AHP 6, 6CHZ 3, 6BUR 8, 6RN 129, 6BLS 78, 6CMQ 56, 6ANO 187, 6CUW 80, 6CAP 13, 6AKW 30, 6AJI 6, 6BQ 58, 6BDE 16, 6SB 14, 6AJM 14, 6BAS 8, 6CHX 5, 6CGC 2, 6CAE 40, 6DAA 37, 6NW 117, 6CFN 142.

Northern Section, P. W. Dann, Mgr.

Checking over ORS's, there are about 70% active or reporting while the other 30% are not reporting. If you want to keep your ORS, don't forget to turn in the card which you receive each month from Headquarters.

Dist. No. 4—It's 6OI again but this time he worked SIX continents within a week, including NTT in Italy, O-ASB in South Africa. X2BG, F18LBT, RFC6 and all on a fifty watter with 200 watts input. 6OI has been given wide publicity and Pathe has taken his station as he now holds the Long Distance record for the United States. 6NX's 7.5 phone set on OBS has been heard all over entire Pacific Coast. DeForest "H" tube and RCA 50 watter used on forty. 6BON hears many Pi (?) stations, also A's and Z's regular. 6CKV uses a small antenna working on fundamental and gets out FB. 6AJZ tried to use phone with his fiver with disastrous results. 6BMW's 50 went West—using "H" tube now. 6AIH is high traffic man of the district. 6ALW is obtaining dope on antennas by experimenting with them. 6AOI worked PI-NIPM. Is using the KFUH circuit and is going to try crystal control. 6AME, on one day and heard PI. 6CUX is using "S" tubes with good results. 6CLP worked his first Aussie to begin the New Year. 6CIS is experimenting with the link system with coupling coil outside of shack and reports its works FB.

Dist. No. 5—6WS has a new tube going and is QRV traffic. 6FH reports the following: 6DD on 80 again, reports poor luck on 40. 6BKB likes 40 so well that he's going to stick there. 6FH is working well on 80. 6GX, rebuilding. 6CHL and 6AWT were the only stations reporting in San Francisco. 6CHL has worked BER in Bermuda and X2BA in India and has been QSO the P. Is. 6AWT reports being QSO most all countries in the Orient and wkd X2BA. 6AKU is installing two 7.5 watt tubes in power amp circuit working 20, 40 and 80. 6ANW is doing good work on 40 and 80 with his new fifty. 6EW heard G2SZ and O-A3E. 6EW is using a 5-watter but will be on with a 200 watter soon. 6AOA is operating 6BCU's station and has heard two Britishers, one African, one Chilean, one Argentinian, including JIPP on voice. 6CTX was down on 40 but says 80 is better for traffic. He has schedules with East Coast fellows at 3.30 A. M. A slight increase in traffic is shown for Berkeley. 6GU is experimenting with a low power transmitter and getting out f. b. 6BCQ, using one 5'er is QSO East Coast. 6IM, new ORS, is getting out F. B. on one fiver. 6ZD is on the air quite often now and has a schedule with Hawaiian 6BCU. Listen to these two fellows if you want to hear how to handle traffic. 6CLZ finally raised his pole and when everything was apparently O. K. for operating, found out his fifty was N. G. so until he gets a fiver he will be off.

6CMG on 40, using MO set, is QSO HUGAFF, 6DBL, FXI, NPM anytime. He is waiting for an "H" tube. 6ALV too QRV but hears South Africa consistently. His same old fifty is doing its stuff. 6CAX is doing splendid work. He is making schedules with several outlying stations. 6VK-6WP blew two fifties??? and then bought two new ones. They are experimenting on 5 meters. 6AHG with his lone 5 is doing fine work. 6AUY is coming back. He's been very busy in Piedmont. The YL must have given him the air??? 6NH is waiting for an "H" tube. 6CCT is doing F. B. with 7.5 watter, having worked two A's, Brazil, Bermuda, Argentine and P. R. 6RJ is keeping a schedule for 6ZX with 6UO as 6ZX's fifty went west. 6RJ has lost three fifties in the last week, but still keeps going, oh! boy! how do you do it??? 6SL has been doing good work with a 7.5 watter with a Hertz Antenna being QSO East Coast and Hawaii.

Dist. No. 6—Hurrah! We have another ORS in Eureka now as 6BWR has joined the ranks. F. B.! 6BWR has a 93 ft. stick up and will be on with 50 watter.

Dist. No. 7—6GA of Reno, Nevada is now City Manager there. Our old friend, 6ZO, will be back on with 15 watts soon. Glad to see you back Beedle, rush it! 6CCA ready to come on the air too, show speed, OM. 6GA ex-6BEH, says the GA on his new call stands for Go ahead and he is going to do it. 6AJT is constructing a low power outfit and hopes to

win the "Most Miles per Watt Contest" of the Jewell Instrument Co. 6UO has a new DeForest "H" tube and using 1,600 on the plate says FB. He sure pounds in Oakland in great style. 6BIP? D. S. was a recent visitor at his home in Fallon and is back on the Coast by now.

Traffic: 6GU 8, 6ZD 34, 6BCQ 27, 6IM 9, 9CEG 1, 6BLT 11, 6CVR 6, 6CIS 26, 6CLP 9, 6CUX 17, 6AO1 10, 6BVY 33, 6NX 5, 6BON 20, 6CKV 19, 6AMM 16, 6OI 38, 6AJZ 1, 6BMW 23, 6ALW 23, 6AIH 103, 6EW 24, 6ANW 144, 6AOA 124, 6CTX 48, 6UO 26, 6CWN 6, 6CMG 10, 6RJ 31, 6CQG 3, 6ALV 11, 6CAX 27, 6VK 18, 6WP 23, 6AHG 31, 6AUY 2, 6CCT 175, 6SL 11.

Hawaiian Section, K. A. Cantin, Manager

The Radio Club of Hawaii, 6BUC, has obtained reports from amateur stations in England. A short wave "Super" is being tried out in hopes that European stations will be heard and communication established. 6BUC wants traffic for Hawaii or will QSR messages for stations on the Pacific. 6AFF handles his traffic and station in an efficient manner and DX stations seem to be aware of the fact for considerable traffic for Hawaii was routed to him. 6AFF has established communication with PL-IAU in addition to PL-IHR. 6CST has arranged several schedules for handling his traffic. He was QSO with JOC (Japan).

6AJL was on the sick list for several weeks. 6DB is on the air occasionally. 6ASR has been experimenting with reception on 80 meters. If results are successful, he plans to use two transmitters, one on 40 and another operating around 80 meters. Reception is very poor on 40 due to some unknown reason.

6TQ rebuilt his transmitter and his first DX station to QSO was NKF. 6TQ does most of his work with the 6th district. 6CLJ is a new station anxious to arrange schedules for Saturdays and Sundays. 6CMH, 6AJE and 6BDL are all QSO with mainland stations. 6DCF keeps in contact with KFUH whose QRA is now "somewhere in the South Sea." The QRA of 6CN is Naval Submarine Base, Pearl Harbor, T. H. Considerable communication has been carried on with amateur stations by 6CN.

Traffic: 6AJL 10, 6BUC 74, 6AFF 50, 6CLJ 37, 6CST 15, 6ASR 8, 6TQ 8.

ROANOKE DIVISION

W. T. Gravely, Manager

NORTH CAROLINA—Dist. No. 2—4TS is doing his best in spite of QRM from his stove, trying to get a DC QSB. 4MI is still trying to find the best antenna for his poor location. 4SX took to 40 meters like a duck to water and worked France the first week. 4GW is QRW on BC sets. 4OU is handling traffic with a UX-210 on 80 meters.

Dist. No. 3—4RY is stirring things up on 40 meters. 4BX is having trouble raising anyone on 40 meters, and to make bad matters worse half his mast came down. 4TJ is stepping out fine on 40 and 80 with a couple UX-210s. 4QK is having trouble on all sorts on 40 but steps out fine on 80. 4JR is keeping the air warm on 40 and 80.

Dist. No. 4—4RW is doing fine work. Old 4FT is threatening to open up with a 250 watter. 4NT is QRW business.

Traffic: 4RW 32, 4TS 33, 4MI 45, 4QK 26, 4TJ 30, 4RY 23, 4JR 27.

WEST VIRGINIA—Things are brightening up considerably.

Dist. No. 1—8AUL star station. Worked 8AR at Newfoundland. Operates on 500 volts B batts now. 8BSU and 8CDV working West Coast. Building new rectifier. SSP promises to be on soon.

Dist. No. 3—8CAY joined Naval Reserves. FB, OM, hope QSO soon.

Dist. No. 4—8BXP uses low power and works 1000 miles.

Dist. No. 5—Huntington seems alive with interest. New ORS, 8DRR. 8AYP seems most active. 8GBR says he has best QSB in the state. 8DOI and 8CBB knocking off DX. 8ATC, 8CQH and 8DNJ doing good. 8AMD rebuilding. Two operators on duty.

Traffic: 8DOI 29, 8ATC 21, 8CQH 13, 8AMD 24, 8AYP 192, 8AUL 62, 8CDV 15, 8BSU-8AKZ 11.

VIRGINIA—Dist. No. 1—3UX is a new station. 3CEL planning to go up to 80 meters so he can handle traffic. 3CKA had a 50 wtr on 40 and worked west coast and Panama. 3QF has a new UX-210 on 40; 8AHK using a five watter on 40, no results yet.

3MK working with poor results on 40 using 50 watter. 3SB returned from trip into Penna. 3TI has a five watter on 40. New chemical rectifier seems to have hit the combination. 3BNE continues to reach out after them.

Dist. No. 2—3BMN says his radio shop keeps him QRW. 3AUU also QRW radio shop. Will some of the hams in Richmond and also 3APR please let us hear from you. If you're dead, we'll send a few flowers.

Dist. No. 4—3RX at V. M. I. has a set going on 80, 150 and 40. 3AAI complains of QRM from power line. 3BGS untale to get regular set working trying low power with receiving tubes working locals. 3KG tries to reach out with B batteries. 3CFY joins the gang with low power receiving tubes. 3CKL seems to have the only location in the state for DX or he has better luck. Works the A and Z stations and most everything else he hears. Blew up a five watter. In nine days worked a total of 79,000 miles using three five watters. 3BGP worked at his station during Xmas holidays. 3BVL assists 3CKL sometimes. 3BZ works around on 40 and 20 meters. Says some of the foreign stations must have tin ears or they would answer his sigs. Did work F-3CT for while. 3CA has worked 3CKL 40 miles and 3BNE about 200 miles in daytime but does not hear either of them after dark on 40 meters. 3BZ complains that he cannot hear 3CA in daytime nor at night time. 'Sfunny game!

Traffic: 3BNE 22, 3UX 30, 3CKA 27, 3TI 20, 3RX 6.

ROCKY MOUNTAIN DIVISION

N. R. Hood, Mgr.

COLORADO—Denver—9EAM comes to the front this time with a total that makes it look like he doesn't sleep since he has to work 15 hours a day to earn a living. Some of you fellows who have nothing to do but go to school should look at this and take notice. 9EAM kept a schedule with 9BKV and 9BFG. 9CAA put in some pretty fair work, and kept schedules with 7HX and 9DXY. He has a schedule with 6BTX for west bound traffic. He reports that it is hard to hear 6s, and he has had to QSR via the 7th dist. because the 6s he did hear were DX hounds! 9WO reports the same difficulty with west traffic, and had to mail most of his stuff. 9BDF has worked ALL districts, and was heard in Germany, with only two bed springs about 10 feet apart and a wall between them for antenna and cpse. FB, OM. The OM at 9BDF is moving to Southern Colorado and the YL will now be the 2nd op at 9CAA. 9OO seems to have trouble in getting tubes to suit him. He bought ex-9CVC's M. G. es a very marked improvement in his note has been noticed. 9DQG is building an 80 meter fone and this together with running KFEL has kept him off the air. 9DKM is going strong on his 7½ watter. 9BJK may get some time to be on again soon. 9BJN is doing fine work on 40. 9EEA is on the air but still lacks a rectifier, and until this is working, he refuses to operate. 9DED will be off the air until June as will 9EFY.

Dist. No. 1: 9DVL visited some of the Denver gang around Christmas. He is now moving to a new QRA in Ft. Collins and will be on with a new 7½ watter. 9AOI is on 50 watts with pure DC. He does most of his work on 40.

Dist. No. 2: 9ADI seems to be setting right into it for a new station. We hear rumors that he used to be an 8 which may account for the high total, but even so, he is second highest in the state. 9CFY is on regularly. 9BUG and 9DUI have applied for ORS. 9BUG is the former ADM of Maine. He uses an in-door aerial. 9DUI sports two operators. 9DFH and 9CLD are hard at it. 9CDE puts in his usual time at the key. New ORS are 9CFY, Co. O. Ford, Colorado Springs and 9BUG, Dick Chase at Colorado Springs.

Traffic: 9CLD 90, 9EAE 16, 9DFH 32, 9AOI 155, 9CDE 19, 9CFY 12, 9BUG 12, 9BVL 40, 9AOI 56, 9WO 20, 9DKM 52, 9OO 21, 9EAM 182, 9CAA 132, 9BJN 34, 9BDF 20.

UTAH—Considerable more pep has been shown and we have more activity now than ever in the League's history of this state. Let us hope that this condition may continue to improve.

Dist. No. 1: 6CJB is on a trip in Idaho and was not able to do much for the past month. 6CVA, a new station operated by Clarence Smith, of Bountiful, reports handling 15 messages and requests an ORS. 6CVA is constantly on the job in the evenings.

OGDEN—6FM is the only ORS at present but 6SI is being issued a certificate now and we look for some good work from him. 6FM handled 11.

SALT LAKE CITY—6AED handed 20. 6AKM is using a new 7½ watt tube and is putting good signals to the east coast. He handled 48. 6BTK is being made an ORS. His work is very consistent and he is operating one of the best stations in Salt Lake. He handled 127 messages. 6CRR is using a new DeForest tube and is doing excellent work with it. He handled 42. 6CSD and 6CVY are installing this type of tube. 6RM takes the top hole this month with 245 messages. His transmitter operates on 38 and 79 meters and his best work has been with a2YL. He also works z1AX and many other Australians and New Zealanders. He reports hearing BZ stations as early as 2.30 pm. 6RV handled 86 with a 5 watt tube. 6ZT reports hearing a station on about 55 meters signing ARM and calling E. Information is requested as to the location of this station. ORS certificates for 6BLH and 6CBU are cancelled. They are out of commission. New ORS are 6SI, W. G. Garner, Ogden, and 6BTX, L. D. Stearns, at Salt Lake City.

Traffic: 6AED 20, 6AKM 48, 6BTK 127, 6CRR 22, 6CVA 15, 6FM 11, 6RM 245, 6RV 86.

SOUTHEASTERN DIVISION

A. D. Trum, Mgr.

ACTIVITY in this Division is increasing and it is gratifying the way the boys are handling traffic. The DM would like to see that every ham in the division becomes an ORS and it is suggested to the ADMS, DSs and CMs to offer competitive prizes in order to get the fellows interested and ambitious to secure an ORS. There is a need for more Army Amateur Stations. Florida has not secured the representation of QST as it deserves in account of the fact that there have been two changes of ADMS. Watts resigned after service of one month on account of business connections. Mr. E. A. Rosseter, 4TV, is the new ADM and it is requested that all ORS in Florida send in their reports to him via their CMs and DSs. The DM can say that the Florida hams are true to form in handling their work and much praise goes to them.

ALABAMA—The new year finds amateur activity in Alabama showing renewed interest with twelve stations reporting a total of 371 messages. This shows an increase of five stations reporting and an additional 302 messages handled during the month. District No. 3 leads with a total of 263 messages. 5DI, of the same district, leads the state with a total of 104 messages.

District No. 1—Mr. S. K. Sawyer, of Birmingham, known everywhere as 5VV, has been made DS. He has a hard task ahead of him but we all believe he can whip this district into shape. 5ACM promises to be heard again at an early date. 5AIW will be on the air with a 20 watt set operated by our old friend 5QP. It is to be very much regretted that Birmingham, the largest city in the state, shows the least activity. 5AX shows the most pep and pounds the brass on 40. 5VV is getting away with a 5 watt in good shape. 5AWF is able to handle traffic consistently.

District No. 2—District Supt. Hurley, of Mobile, sends in a mighty good report. 5AC, 5DL, 5LC and 5JN have been accepted for appointment as Army Amateur Stations. 5AC has been appointed SPECIAL station for the 173rd Infantry, and 348th Brigade, Headquarters Company with 5LC as alternate. 5AAD promises to have them in line before long. 5AAD has deserted 80 and is hunting new laurels on 40. 5LC is on the air and has been reaching out in fine shape. 5ATE, the station of the 31st Signal Co., at Mobile, is using 10 watts but will increase to 100 watts. 5AC and 5DL placed a cigar box in the elevator of the Gulf Mobile and Northern RR for Xmas messages and collected 31 honest to goodness messages during the holidays. The first message through was for Pasadena, Calif., and was QSR direct to 6AEC the same night. 5QK has been heard in England and 5AC has reports from Italy, South Africa and South America. RZ, R, G, F, NZ, African O-A3B and O-A4L have been heard at 5AC.

Dist. No. 3—From Montgomery comes signs of plenty of activity. 5DI got home for the holidays and broke loose with some real work. He got down on 40 and handled 104 messages. 5AJL is a new man but promises to make good and make a brass pounder of his OW. 5ADA promises to break all laws of gravitation and claim that he can be a DX hound and handle more traffic at the same time. Can it be done???? 5AJP, our DM, still finds time to pound the brass besides fill his duties as DM. 5AJP is the main spring for the Montgomery works and is

the best all round ham in the state. 5ATP would like to know the QRA of FAS. Can anybody furnish this information? (5ATP deserves honorable mention as the best all round station and ham in the state instead of 5ATP—DM).

Dist. No. 4—5YB is on the air with a fine bunch of ops pushing the key regularly.

Traffic: 5AC 31, 5AAD 11, 5ADA 56, 5AJP 26, 5ARJ 3, 5ASU 5, 5ATP 72, 5AX 8, 5AWF 23, 5DI 104, 5QK 20, 5VV 9.

PORTO RICO—The gang in Porto Rico is now all on the air, practically every night. 4JE has done the best work this month. 4BA is doing excellent work. 4KT keeps his nightly schedules with New York with clock-like regularity. 4BJ is also QSO New York every night, but is especially dependable for San Jose traffic. 4UR is working Europe and handling traffic. A new ORS certificate has been issued for this District and the honors have gone to PRASA. Congrats.

Traffic: 4JE 24, 4SA 17, 4KT 12, 4BJ 11, 4UR 7.

SOUTH CAROLINA—We are glad to say there are also many "Old timers" back in the game. We amateurs of South Carolina are endeavoring to make our stations "good" in the fullest sense of the word. We are always "QRV" traffic and ready to "chew the rag" any time.

Traffic: 4AAM 9, 4MV 56, 4VQ 72, 4JV 14, 4IT 91, 4RR 30, 4JK 18.

GEORGIA—4AAH (congrats on ur reports every month om) is going FB now with a 50. Was heard in Italy and England on a 5'er with 35 watts input. Messages 47. 4AAD now has a 55 foot lattice tower. 4CF too much 60 cycle hum but has been called by Aust. as NZ 4CP. 4DO is imitating the well known clam, BCLitis? 4HS will be back on the air with a 50 and 4IO, mourning the loss of another good mast, is starting at the bottom of the ladder in the fruit business under his DAD. 4KL is doing good work. Handled 7 messages. 4KW is star op at EV-8 and is making it hum. 4NW heard occasionally but Scout work takes most of his time. 4OA has a good set and antenna but thinks too much of YL. 4QE, a perfectly good 250 watt set to waste. Same as 4OA. Hi. 4RM has the empty socket blues. After working 7 countries in one nite the old 203A gave up the ghost. DX O-A6A and O-A3B worked. Now 25 countries. Heard by AQE near South Pole messages 30. 4ST soon to be on again. (All Atlanta hams are requested to give him all the help that they can as he is crippled. Look him up and ask him to let you help him in any way. Tnx—CM). 4ZA "Dobbs the Silent" now working on crystal control but it seems to be a secret for he never comes "coco" with any news. EV-8 sure getting out FB for a bum location. Heard in England and Panama. QRA-Ga. National Guards, Atlanta, Ga.

FLORIDA—Florida hams suffered the loss of two excellent ADMS and fine fellows in the resignations of Clarke and Watts. As officers on account of business relations, they are on the air some of the time carrying on the good work they preached. With changes in the ADMS, came confusion as to reports that were turned in and hence Florida lost the good representation the fellows deserve. The DM has had the pleasure and opportunity to work some of the fellows in Jax, Miami, St. Pete, Orlando and some of the others and it is his pleasure to say that he never has worked any other fellows with more amateur enthusiasm, for traffic handling with good form, and rag chewing.

WEST GULF DIVISION

F. M. Corlett, Manager

NORTHERN TEXAS—School QRM is still predominant in our section. 5JF reports that a 250 ft receiving antenna, as per 9ZT, is the stuff for DX reception.

Traffic: 5JF 5, 5AKZ 44, 5SD 11, 5ACL 23, 5AKN 8, 5FY 34, 5AKL 13, 5CC 4, 5AJJ 17, 5SP 49, 5NW 69.

SOUTHERN TEXAS—Reports are rather meagre this month—maybe the mails got tied up in the deep snow. hi! Stations reported fairly well but it seems there was not much to report. 5EW reports that he has been very QRW with KWWG and school. 5WW moved into our section about two months and we were very glad to have him. But now we find that he went back to Center, Texas in the Northern Texas section. 5HS and 5HC report but handled no traffic. 5OX also reports no traffic handled but he continues to do good DX. We regret having to report the resignation of L. D. Wall, DS of West Texas. But he has done so to accept a greater responsibility, that of Army-Amateur intermediate. We regard it as a signal honor

for a man in our section to get this position. In the meantime, all stations in this district please send all communications to the ADM until a new DS can be appointed.

Traffic: 5EW 18.

OKLAHOMA—January proved to be a banner month from a traffic standpoint with the Oklahoma hams and seems to forecast an active year. 5AAV sold his old 5 watt transmitter and has completed a 7½ watt. 5ATK was AWOL this month. 5AKA is a new League member on 40. 5ADE is operator for broadcasting station KFXR recently completed for a local firm by the ADM. 5ATV still doing good work although not as good as usual. 5SW is "sawing wood" with his reliable 10 watt. 5UJ handled a death message for a U. S. Major General in the Pacific Ocean. 5AQW is only one upholding Enid's honor at the present time and deserves comment for his faithfulness. 5ABO still lining 'em up in his neck of the woods and reports traffic good on 175.

Cushing seems to be the real center of Oklahoma Hams activities, etc. 5ANL has lined his gang up and they certainly stepped on the gas. All waves in use here. 5ANL says he will take on Oklahoma City or Tulsa for a traffic contest or take 'em both combined. 5ADO, on with 150 watts. 5ASK has his H tube and we wish his luck with it. 5APQ is high man in District No. 1 and his schedule with 9APY probably has something to do with it. 5PU says that the main thing is QTC and says his junk is perkin' fairly good now.

Dist. No. 4 whopped her up and made a good scoop when 5VM stole a march on the Oklahoma City hams and arranged with the first Annual Radio Show of Oklahoma to handle traffic for visitors. 5VM handled over 800 and reports about 800 more hanging on the hook. Duncan has harned into the air with 5AGO operating a 5'er with raw AC working 10 states the first four nites on. 5ARX got a hunch and has started in with a vengeance and is lining some others up to keep us in touch with the higher band. Considerable experimenting is taking place in Oklahoma and we think that the results should be known. Let's have more reports. Make it 25 with traffic handled by March.

Traffic: 5APG 1, 5UJ 13, 5ANL 19, 5ADO 41, 5APQ 106, 5AAV 12, 5AQW 6, 5ASK 3, 5ATV 30, 5PU 8, 5ABO 23, 5SW 21, 5ARX-AIB 18, 5AKA 3, 5JU 23, 5VM 312.

CANADA

MARITIME DIVISION

W. C. Borrett, Manager

1AK HAS JOINED THE 10,000 MILE TRIBE BY WORKING NEW ZEALAND 4AV. 1DQ ORIGINATES 65 REAL MESSAGES. 8AR HAS WORKED EGYPT.

Tom Lacey sending in first report from 1AQ of Fredericton, N. B., reminds us that New Brunswick is slowly but surely becoming the busy section of the Maritime Division with this new addition to his forces. Nova Scotia, however, is not dead by a long way. 1CX of Glace Bay is very active and reports that there are four active ham stations in his town. 1AE is on 150 meters. 1BF, our newest station, has worked many US 1s and 2s. 1DM is putting in some new 202s. 1BD, the enthusiastic young Marconi of Sydney Mines, is back on the job. 1BZ has been seriously ill, but is now on the air again. A new P E I station was heard on the air this month using a "bootleg" call. Signs of life over there, anyway. 1AQ using B battery plate supply has been QSO Montreal and several US 1s. 1EI reports working XIB. 1AK has kept watch every afternoon and has made such a strong come-back, deserves special mention, having originated 65 messages. 1AR reports that he is logging many Chilean hams at night as well as Australian and Europeans. 1DD exchanged signals with German 4LV and also was first to hook Irish 2IT. The German man also worked by 1AR about ten minutes after 1DD had to give him up on account of weak signals. 8AR has worked our Labrador station, BHL (VOA same thing), and in addition to working Finland, England, France, etc., he has the honor of being the first to QSO an Egyptian station. 8AW is on with low power. STATIONS NOT MENTIONED IN THIS REPORT HAVE FAILED TO REPORT ON TIME, THEREFORE THE DM WISHES TO REMIND THE GANG AGAIN TO PLEASE MAIL THAT REPORT ON THE 15TH OF EACH MONTH. GIVE HIM

QST FOR MARCH, 1926

THE DOPE AND YOU WILL THEN GET THE CREDIT FOR YOUR WORK AND BE DOING YOUR BIT TO PUT THE MARITIME DIVISION ON THE MAP. ALSO TRY AND GET ON 52.51 METERS ON WEDNESDAY NIGHTS AND WORK YOUR BROTHER CANADIANS. SHOW SOME NATIONAL SPIRIT.

Traffic: 1DQ 65, 1EI 2, 1AK 48, 1DD 14, 1ED 5, 1CX 2.

ONTARIO DIVISION

W. Y. Sloan, Manager

NEW TRANSCANADA WAVE FULFILLS ALL EXPECTATIONS. NEW FIFTY WATTER BLOWS RIGHT AFTER AMATEUR BREAKS LOOKING-GLASS "ROYAL ORDER OF GLOBE TROTTERS" INAUGURATED AT RADIO CLUB PRE-WAR HAM REUNION.

Things are booming in this division. The ADMs are right on the job, and the new ORS certificates are being distributed as quickly as possible.

NORTHERN ONTARIO—The new Transcanada wave is a great help to our low powered transmitters, as they are now able to conduct schedules that were formerly impossible due to the excessive QRM and the annoying "skip-distance" on the 40 meter band. 3HP mourns the loss of a tube. 3GG remains up high, but with a little persuasion will come down to 52 meters for the weekly hamfests. 8AN intends to open up with a ten watt. 3NI's two operators are keeping this station on the air all day, every day. Their brand new 203A passed out a few hours after they smashed a mirror.

EASTERN ONTARIO—We take this opportunity to welcome the newcomer, 3BE. 3GJ is chasing up traffic to feed his fiver. 3AEL is QRW teaching the Scouts the code. 3EN seems to be suffering from YL'itis. We heard a station signing 3JW the other day and saying he was ex3EN. Is this a new call, OM?

SOUTHERN ONTARIO—It is with regret that we announce the resignation of 3XI from the position of ADM, but he has been too busy to carry on in this capacity, so it has been necessary to appoint a new ADM at once. J. A. Varey, 3ZB, of St. Catharines, is now filling this position and is certainly off to a good start. 3KA was reported in NZ on his fifty and gutter-pipe antenna. Good old 3KP's log reads like a geography, but he is still on the trail of more super-DX. 3MF lost his trusty fifty after making a name for himself locally by working m1AA. 3ZB has copied everything going including J1AA, but his transmitter fails to keep pace. 3ZD says he is fed up with 40 meters. 3FU gave the League a real BOOST by handling important messages for the local Police. He and 3ZY are using indoor antennas, while 3GY is erecting a 60 foot gutter-pipe.

CENTRAL ONTARIO—With the exception of Toronto, this division ought to be heartily ashamed of itself. In spite of circular letters and bulletins galore, the ADM has not received a single outside report this month. A wholesale cancellation of ORS is inevitable unless some improvement is evidenced immediately.

TORONTO—Everybody is enthusiastic about 52.51 meters, our new Prayer-Meeting wave. It seems to be good for long or short DX at all times of the day or night: we're lucky to get this wave, fellows, let's use it. Remember, every Wednesday at 10 EST. 3AZ and 3BR threaten to give G. F. Jenkins a run for his money. 4AJ had to take a transmitter away with him on his holidays at Hanover, Ont. He can't keep away from radio a minute. The Wireless Assn. of Ont. staged an old-timers' reunion, at which 4AJ played the YL with 9BH in a one-act farce. Contests and inaugural initiation into the ROYAL ORDER OF GLOBE TROTTERS were other features of the evening. 3VH announces his reappearance on the air with a new set. 3FC, member premier of the R.O.G.T., is now wearing crepe—his fifty suddenly departed this life; the fourth blown bottle in this division this month.

Traffic: 3FC 69, 3NI 61, 3BJ 54, 3GJ 32, 3AZ 24, 4AJ at Hanover 31, 3AL 23, 3VH-9CS 14, 3KA 14, 3BR 6, 3EL 5, 3AFP 5, 3CC 5, 3ZB, 4, 3AEL 4, 3FU 3, 3DH 3, 3KP 2, 3CK 1, 3MT 1, 3BE 1.

QUEBEC DIVISION

J. V. Argyle, Mgr.

QUEBEC ORS sure stepped out this month in the DX line though traffic was scarce. Outstanding work was performed by 2BW who worked one Aussie, seven Italians, five Britishers, two Germans

and two Mexicans. 2AX worked Spain, Morocco, Holland, Italy, Belgium, Algeria, and France. 2BG worked Belgium, Italy, France and England in one night. This is fine super DX with a vengeance. 2AG is busy building a transmitter for the Mounted Police to use at the Pole this year, thus fulfilling his promise. 2DO complains he can get no traffic. Attendance on 52 meters was not so good. Montrealers were the first to complain that the 120 wave was no good and now they have this dandy new wave they are afraid to move their helix clips and use it. All Canada is on this wave Wednesday nights and it's sure fine to chew the old-fashioned rag without GRM. Come in on in 52 Wednesday. 2CG has been wandering around Toronto and St. John, N. B., and has done no decent DX lately. 2FO has a new big bottle. 2CH is a new station on air, Carlyle the owner. 2HV, 2AU are on 40 and holding down their end OK. 2BT, 2CI still rebuild.

Traffic: 2BE 10, 2CG 5, 2BG 8, 2AU 5, 2UX 11, 2FO 6.

VANCOUVER DIVISION
A. H. Asmussen, Manager

THE retiring DM wishes to convey his thanks to the various ORS and DS for their excellent co-operation during his term of office. Until further notice, all reports should be sent to Mr. Asmussen, 4GT, who will be the new manager for 1926 and 1927. All ORS certificates are considered as cancelled and those desiring to continue as an ORS must make application to Mr. Asmussen for reappointment. As yet, 5GF has been the only station to do any work on 52.5 meters. 5BJ and 5CP did a bit of combination and got the old heap perkin on 40. 5AS had QRM with the landlady so is doing a QSS to another QRA. 5AG is getting his station licked into fine shape now and is getting good DX. 5AK is on once in a while when he has time. 5BA is experimenting with a Hertz antenna and from the sounds he seems to get best results with a fiver coil as plate supply.

5CT has been testing again on 40 meters but results not so good and 5Z5 nothing at all. 5AM is a new-comer and is getting good results on both 40 and 80 meters. Duncan will soon have another ham, Mr. J. K. Calvalsky. 5HK is going first rate on 80 meters.

4CL, after cruising the seven seas as Wireless Officer, aboard SS Vancolite (VGLJ), is back on the job in Edmonton and is putting out signs with the same old KICK. 4JF is perking on 40 meters. 4AF is a new station in Macleod working on 40 and 80 meters. 4HN is out FB on 20. 4AL is a good clearing station for traffic using low power (two 201 A's) 40 and 80 meters. 4DQ getting good DX with low power; the W is first Op. 4IO still plugging on 80 meter thru bad power leak GRM and is sniffing around on 40. 4GT is very QRW chasing up power leak GRM. All stations in this division please send in your correct QRA to the new DM (4GT).

Traffic: 4AL 8, 4GT 18, 4IO 2.

WINNIPEG DIVISION
F. E. Rutland, Manager

IN spite of the rather poor radio weather during the past month, the Gang has been active and piled up a fair showing. Most traffic was handled on the 40 meter band but there are still a very few consistent on the 80 meter band. The new 32.51 wavelength fills a long-felt want; all the gang will be on this wave Wednesday nights. The star traffic station this month is 4DW, who has done some nice DX with a lone fiver. 4DE lost a 250 watt. 4DY says his new 50 is on the way. 4EA sticks to raw A. C. He gets very good DX, however. 4AW is out of town most of the time. 4AK is busy installing a filter system. 4DW and 4DE hooked up with cIAK. 4DF is handing out a nice D. C. note with a 10 watt M.G. set. 4CR tested out on 52 meters with 4CB early in the month. 4EH and 4CL are two new ones using temporary calls. 4FZ has tied up with 4EA and takes command of the station when in town.

Traffic: 4DY 8, 4DE 10, 4AW 7, 4EA 7, 4DW 10.

TRAFFIC SUMMARY BY STATES

State or Division	A. D. M.	Orig.	Del.	Rel.	Total
ATLANTIC DIVISION					
W. N. Y.	C. S. Taylor	30	20	93	143
Md.	G. L. Deichmann, Jr.	4	7	42	90
D. of C.	A. B. Goodall	—	—	—	316
Del.	No report	—	—	—	—
East. Pa.	J. E. Rau	229	179	687	1020
So. N. J.	H. W. Trencham	49	22	135	206
West. Va.	R. E. Wiggin	105	68	429	605
		417	296	1366	2380
CENTRAL DIVISION					
Ill.	W. E. Schweitzer	403	256	1010	1834
Ohio	C. E. Nichols	—	—	—	1269
Ind.	D. E. Angus	42	25	220	733
Mich.	C. E. Darr	103	12	81	585
Ky.	J. C. Anderson	—	—	—	71
Wisc.	C. N. Crapo	1053	519	1620	2192
		1602	812	2931	6774
DAKOTA DIVISION					
No. Dak.	M. L. Monson	8	7	5	15
So. Dak.	M. J. Junkins	87	54	174	204
Minn.	C. L. Barker	339	193	1512	2005
		409	254	1691	2224
DELTA DIVISION					
Ark.	Dr. Hunter	8	5	42	55
Miss.	June W. Gullett	50	18	97	165
La.	C. A. Frietag	14	4	34	52
Tenn.	L. K. Rush	—	1	78	79
		72	26	251	349
HUDSON DIVISION					
N. Y. City	F. H. Maroon	215	176	786	1175
East. N. Y.	H. H. Ammonhouser	292	114	730	1092
N. N. J.	A. G. Webster Jr.	5	9	77	91
		422	299	1593	2328
MIDWEST DIVISION					
Kans.	C. M. Lewis	29	5	154	179
Mo.	L. B. Lazuro	175	72	598	1082
Iowa	D. E. Warts	—	—	—	730
Nebr.	H. A. Nielson	155	89	540	966
		350	166	1292	2297
NORTHWESTERN DIVISION					
Wash.	Otto Johnson	—	—	—	737
Ore.	Ashley C. Dixon, Jr.	30	27	93	140
Idaho	K. S. Norquest	63	10	43	116
Mont.	A. R. Wilson	50	17	57	124
Alaska	Leo H. Machin	—	—	—	—
		143	54	183	1117

State or Division	A. D. M.	Orig.	Del.	Rel.	Total
NEW ENGLAND DIVISION					
Maine	S. B. Coleman	17	8	191	216
N. H.	C. B. Sawyer	222	101	604	1037
Vt.	G. H. Kiser	6	3	22	34
Conn.	C. E. Nichols	88	77	123	646
W. Mass.	G. J. Green	99	73	248	420
E. Mass.	Cladus Hannah	185	131	357	677
R. I.	D. B. Fancher	96	59	185	240
		836	452	1750	3340
PACIFIC DIVISION					
No. Sect.	J. W. Dann	213	191	783	1162
So. Sect.	L. R. Smith	464	424	974	1862
Hawaiian	K. A. Cantin	128	37	22	187
		815	652	1729	3221
ROCKY MOUNTAIN DIVISION					
Colo.	C. H. Stedman	99	117	977	893
Utah	Art Johnson	174	27	368	569
Wyo.	N. R. Hood	—	—	—	51
		273	144	1045	1513
ROANOKE DIVISION					
No. Caro.	R. S. Morris	31	45	30	216
W. Va.	C. S. Hoffman	92	124	151	367
Va.	J. F. Wohlford	15	18	72	105
		138	187	252	688
SOUTHEASTERN DIVISION					
Ala.	H. S. Brownell	127	188	77	271
So. Car.	A. M. DuPre	—	—	—	290
Ga.	J. Morris	—	—	—	—
Fla.	J. Morris	—	—	—	—
Porto Rico	Luis Rexach	—	—	—	71
		127	188	77	422
WEST GULF DIVISION					
No. Texas	W. B. Forrest, Jr.	66	21	187	277
So. Texas	T. A. Sahn	—	—	—	—
Okla.	K. M. Ehret	369	47	223	649
		435	71	420	926
Manager	F. E. Rutland	18	17	7	42
Manager	W. F. Sloan	—	—	—	263
Manager	A. H. Asmussen	20	5	3	28
Manager	W. C. Bennett	99	23	14	136
Manager	J. V. Arxyle	—	—	—	45
TOTAL FOR THE COUNTRY					
	Originated	Delivered	Relayed	Total	
	5123	2107	13005	27003	